



PARKER MEDICAL SUPPLIES



PMS ENT-ORAL SURGICAL INSTRUMENTS

Product Catalog



+1 (832) 343-3140



info@parkermedicalsupplies.com



www.parkermedicalsupplies.com

2800 Post Oak Blvd, Ste 5600, Houston TX 77056, United States





ENT-ORAL

Scissors	706 - 708
Needles	709
Forceps	709 - 712
Clamps	713 - 719
Tracheal Dilators / Hooks / Retractors	720 - 721
Retractors	722 - 724
Tonsil Dissectors	725
Adenotomes, Tonsil Snares and Wires	726 - 728
Mouth Gags	729 - 737
Tonsil Knives	738
Suction Tubes	739
Adenoid Curettes	740 - 742
Syringes	743
Laryngeal Mirrors	744
Amalgam Carriers	745

ENT-ORAL

Oral Scissors

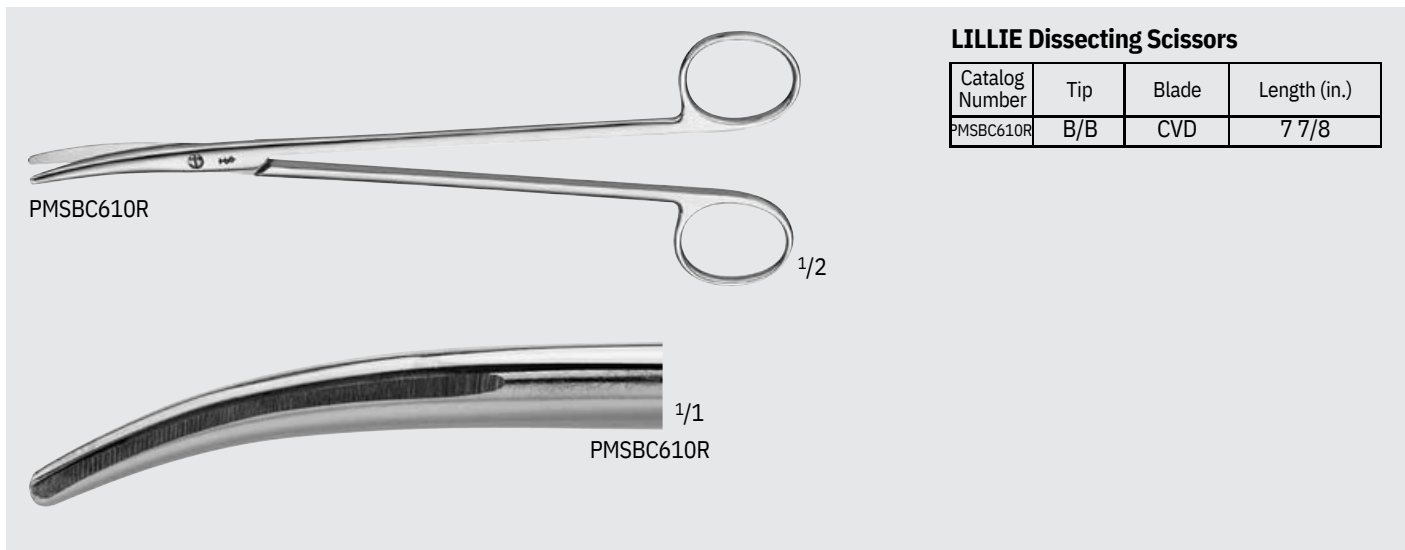

LILLIE Dissecting Scissors

Catalog Number	Tip	Blade	Length (in.)
PMSBC610R	B/B	CVD	7 7/8

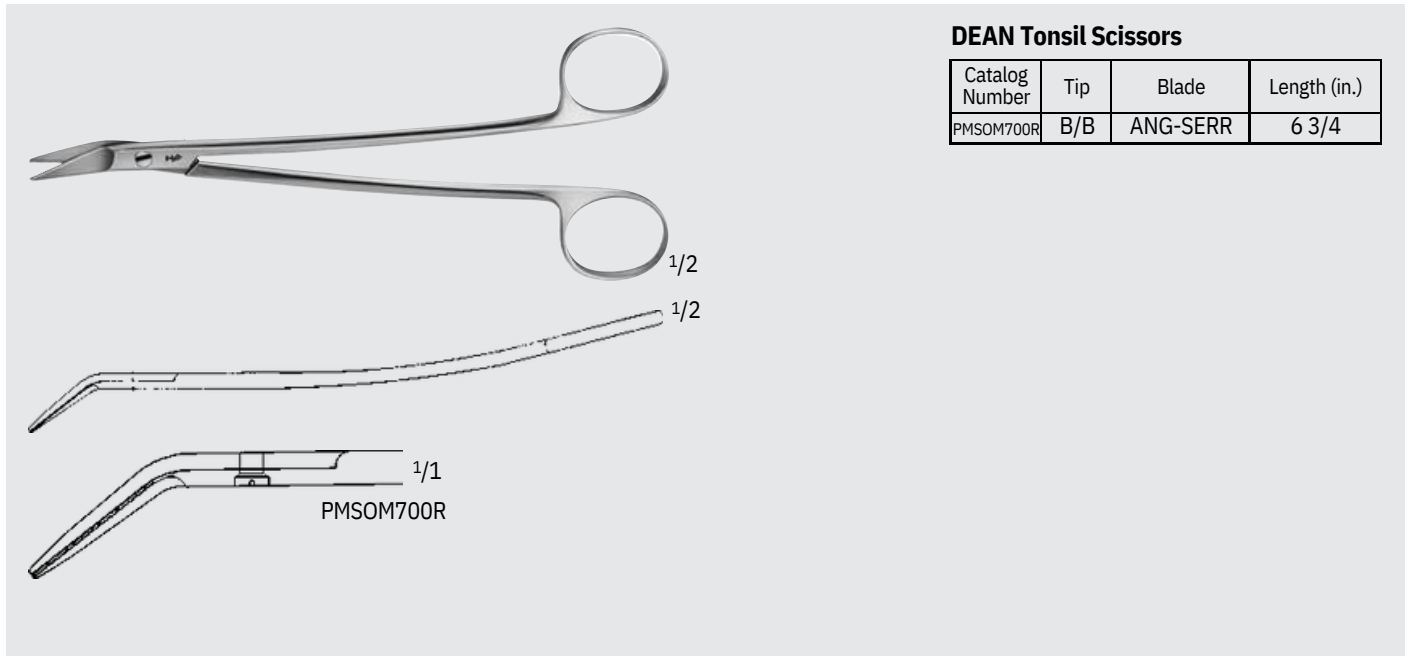

DEAN Tonsil Scissors

Catalog Number	Tip	Blade	Length (in.)
PMSOM700R	B/B	ANG-SERR	6 3/4

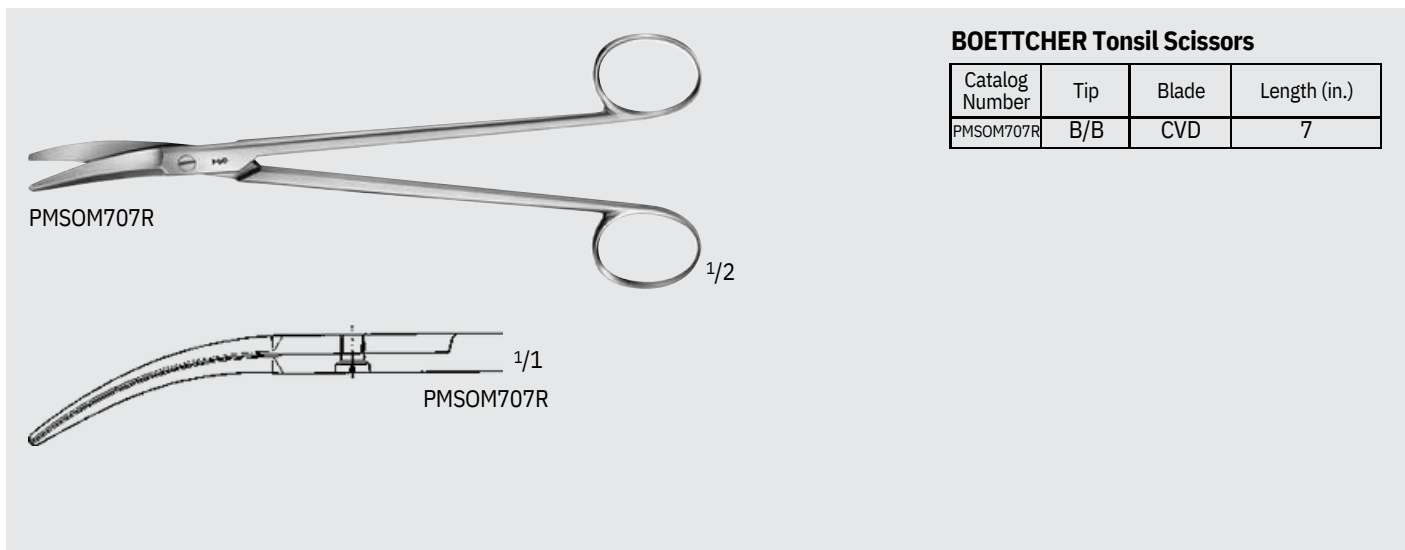

BOETTCHER Tonsil Scissors

Catalog Number	Tip	Blade	Length (in.)
PMSOM707R	B/B	CVD	7

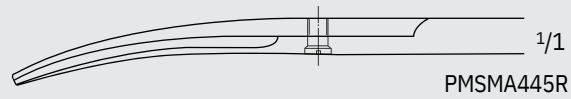

BROPHY Gum Scissors

Catalog Number	Tip	Blade	Length (in.)
PMSMA445R	S/S	CVD	5 1/2

DUROTIP™ Tungsten Carbide Scissors ■ Excellent cutting accuracy ■ Long working life ■ Gold-plated rings

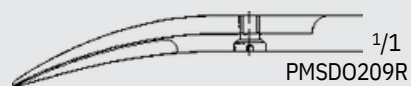
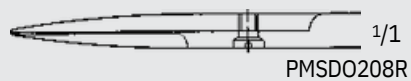

DUROTIP TC Gum Scissors, Delicate

Catalog Number	Tip	Blade	Length (in.)
PMSDO208R	S/S	STR	4 3/4
PMSDO209R	S/S	CVD	4 3/4



ENT-ORAL

Laryngeal Scissors

Micro Laryngeal Scissors, W/ Flush Port

Catalog Number	Tip	Blade	Working Length (in.)
PMSOP310R	S/S	STR	9 3/4
PMSOP311R	S/S	CVD-LEFT	9 3/4
PMSOP312R	S/S	CVD-RIGHT	9 3/4
PMSOP313R	S/S	ANG-UP	9 3/4

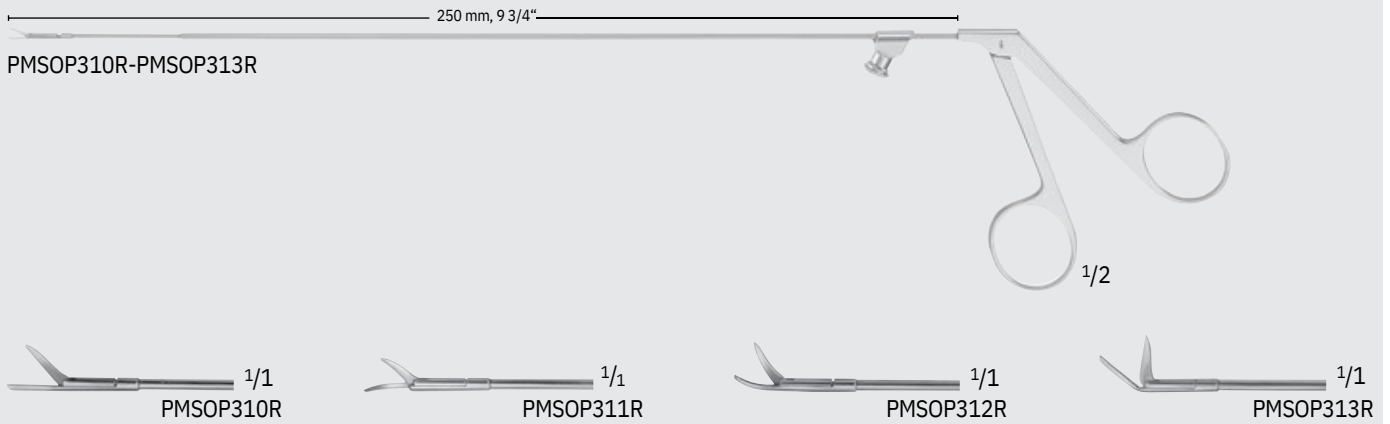

KLEINSASSER Micro Scissors

Catalog Number	Tip	Blade	Blade Size (mm)	Working Length (in.)
PMSMA460R	B/B	STR	4	14

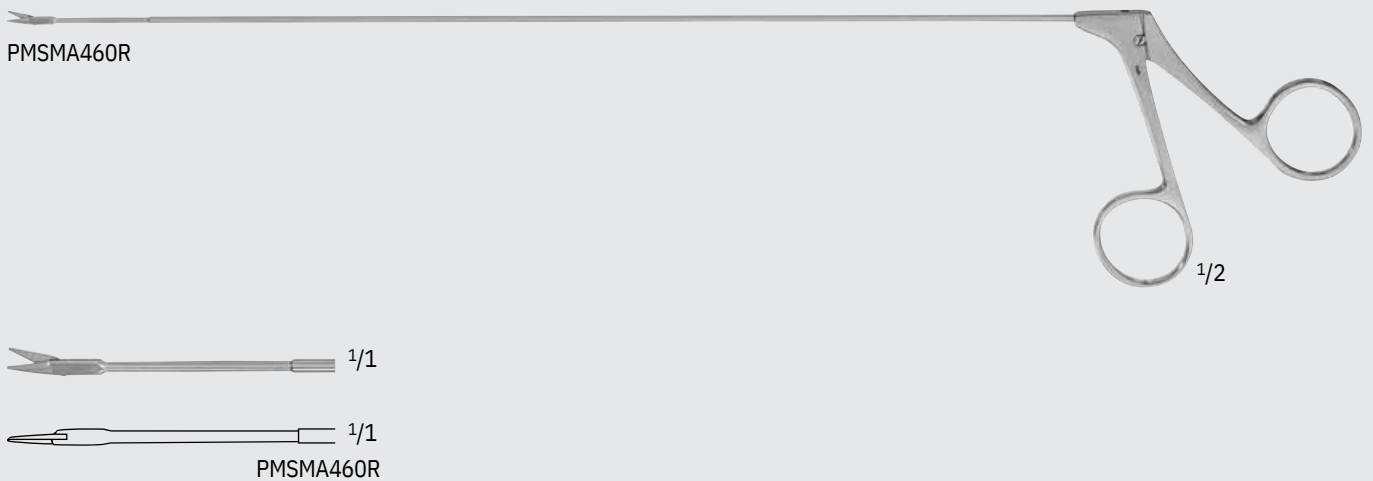

ENT
ORAL

MILLIMETERS

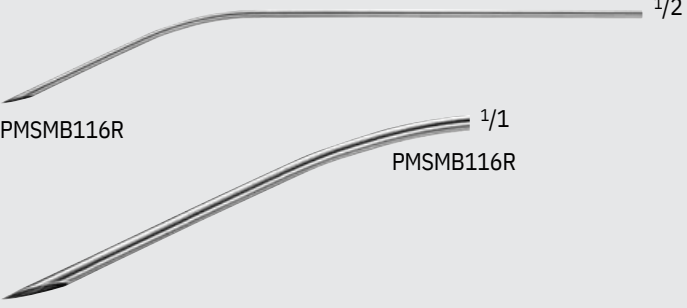

PMSMB116R 1/2

PMSMB116R 1/1

DINGMAN Wire Passing Needle

Catalog Number	Tip	Length (in.)
PMSMB116R	CVD	6 3/4

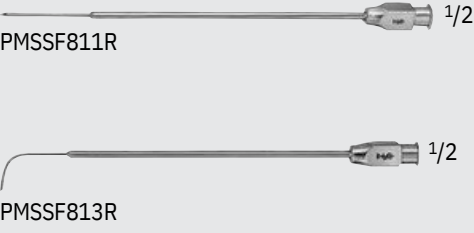

PMSSF811R 1/2

PMSSF813R 1/1

Tonsil Needle, 23 Gauge

Catalog Number	Tip	Tip Size (mm)	Length (in.)
PMSSF811R	STR	DIAM. 0.8	3
PMSSF813R	CVD	DIAM. 0.8	3

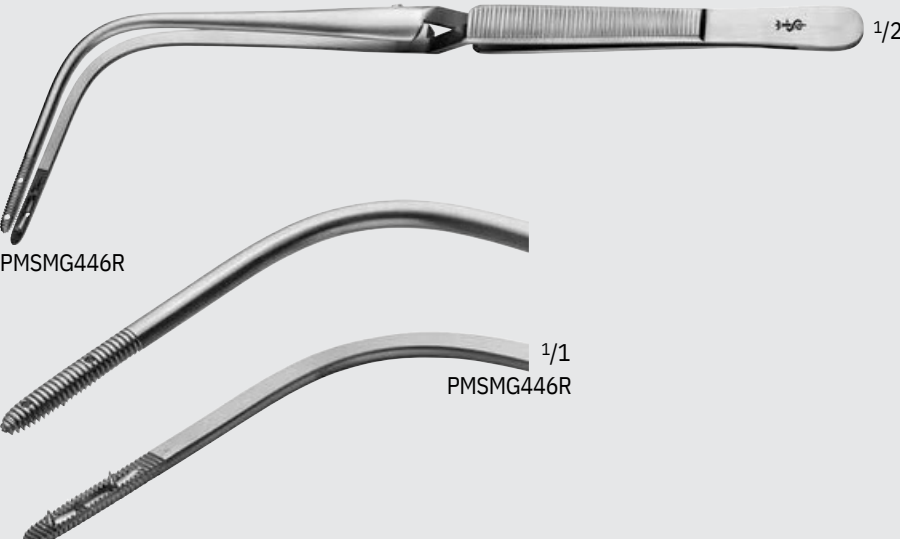

PMSG446R 1/2

PMSG446R 1/1

PMSG446R 1/1

JACKSON Laryngeal Self-Closing Dressing Forceps

Catalog Number	Tip	Teeth	Length (in.)
PMSG446R	SERR	1 x 2	9



INCHES

ENT-ORAL

Forceps

Laryngeal Forceps, W/ Flush Port

Catalog Number	Jaw	Working Length (in.)
PMSOP300R	STR	9 3/4
PMSOP301R	CVD-LEFT	9 3/4
PMSOP302R	CVD-RIGHT	9 3/4

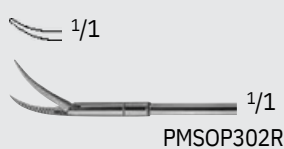
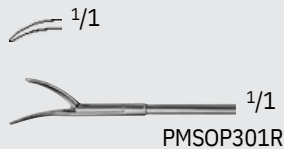
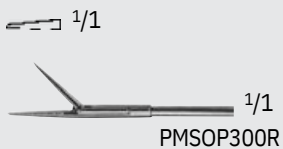
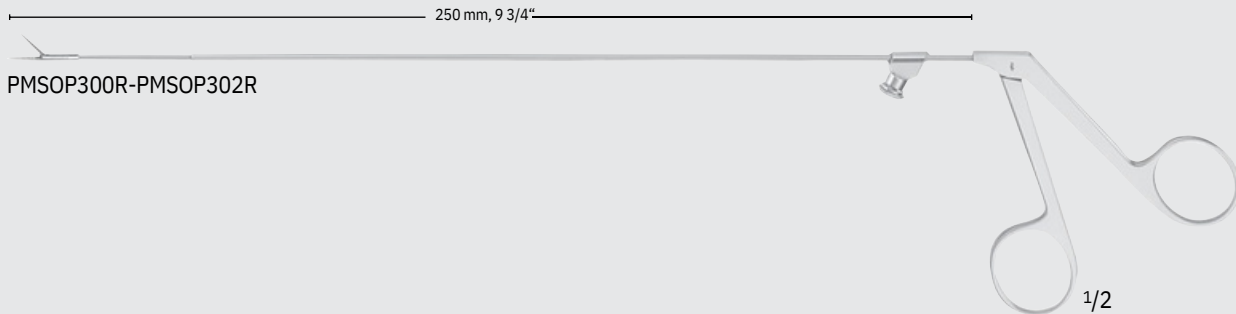

Micro Laryngeal Cup Forceps, W/ Flush Port

Catalog Number	Cup Size (mm)	Jaw	Working Length (in.)
PMSOP304R	2	STR	9 3/4
PMSOP305R	2	ANG-LEFT	9 3/4
PMSOP306R	2	ANG-RIGHT	9 3/4
PMSOP307R	2	ANG-UP	9 3/4

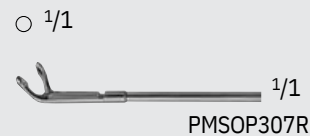
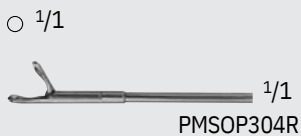
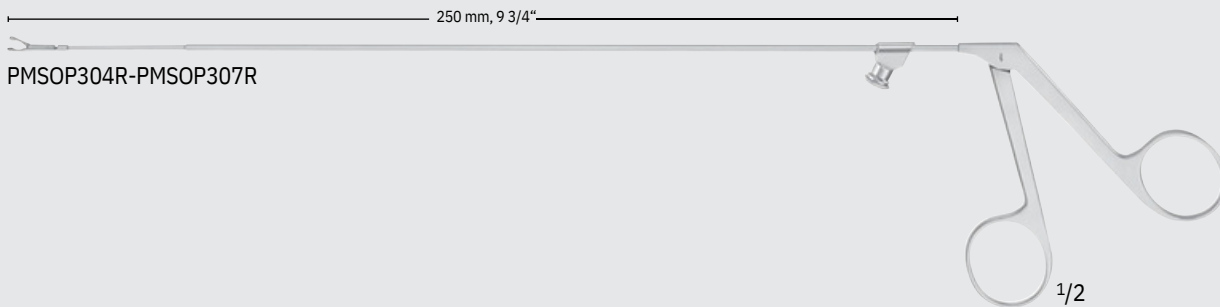

ENT
ORAL

MILLIMETERS

Alligator Grasping Forceps

Catalog Number	Tip	Tip Size (mm)	Working Length (in.)	Length (in.)
PMSMA663R	SERR	8.8 x 4	11	13 3/4

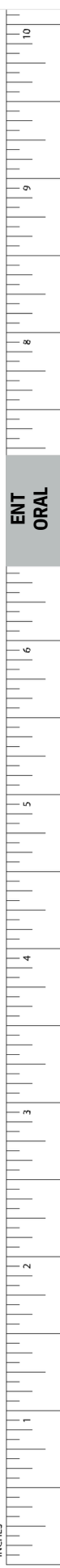
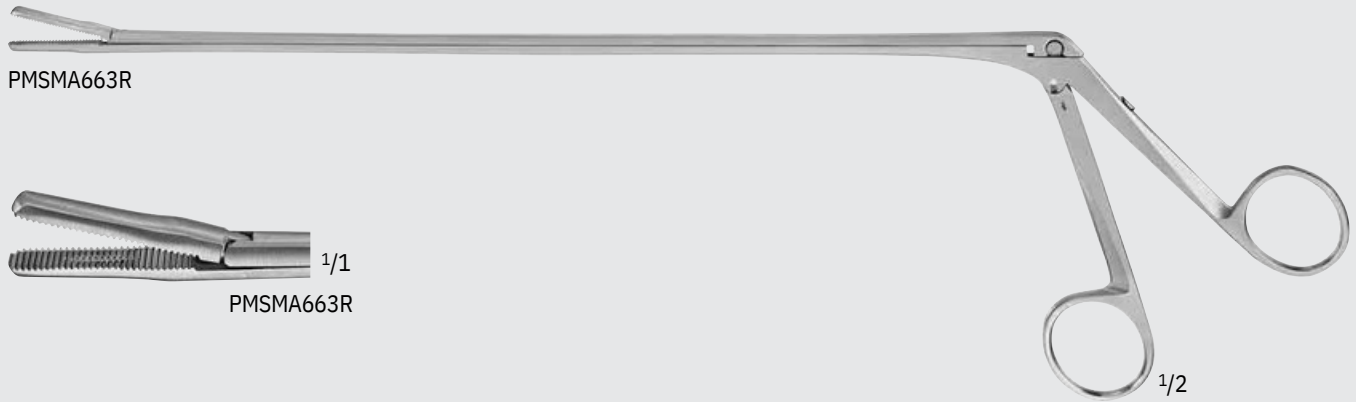

ENT-ORAL

Forceps



PMSMA645R

1/2

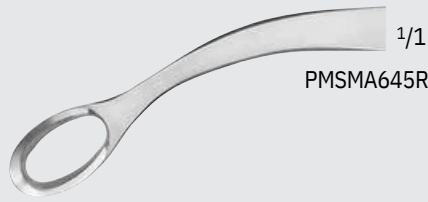

1/1

PMSMA645R

ST CLAIR Adenoid Forceps

Catalog Number	Length (in.)
PMSMA645R	7 1/2

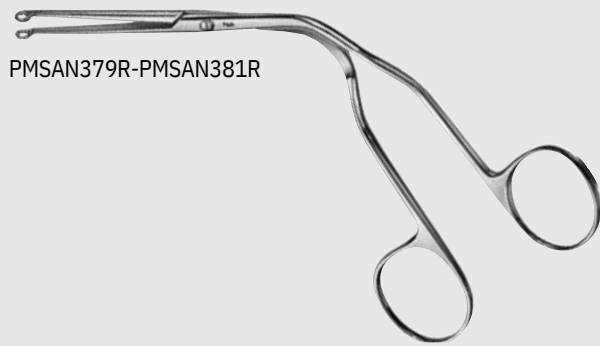

PMSAN379R-PMSAN381R

MAGILL Forceps

Catalog Number	Size	Length (in.)
PMSAN379R	INFANT	6
PMSAN380R	PEDIATRIC	7 7/8
PMSAN381R	ADULT	9 3/4

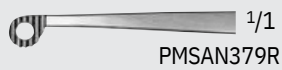

1/1

PMSAN379R

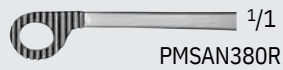

1/1

PMSAN380R



1/1

PMSAN381R

SCHNIDT Tonsil Clamp

Catalog Number	Ring Handle	Jaw	Length (in.)
PMSMA172R	OPEN-RING	STR	7 1/2
PMSBH961R	OPEN-RING	SLIGHT-CVD	7 1/4
PMSBH963R	OPEN-RING	CVD	7 1/4
PMSBH957R	CLOSED-RING	SLIGHT-CVD	7 1/4
PMSBH959R	CLOSED-RING	CVD	7 1/4

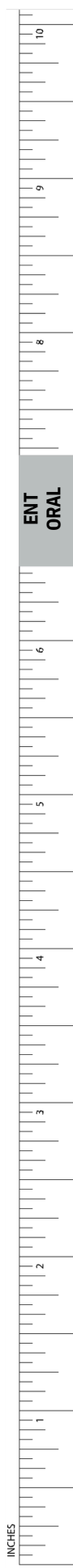
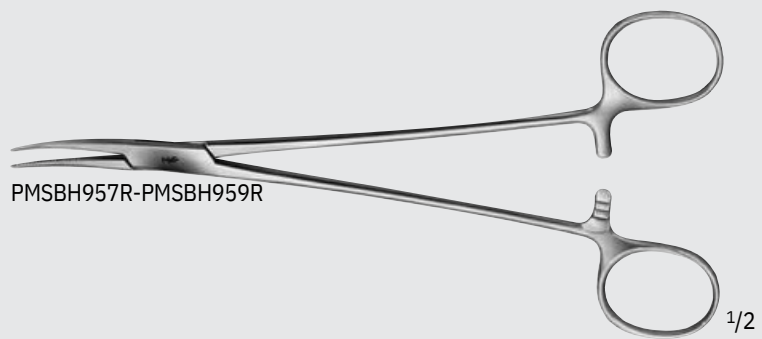
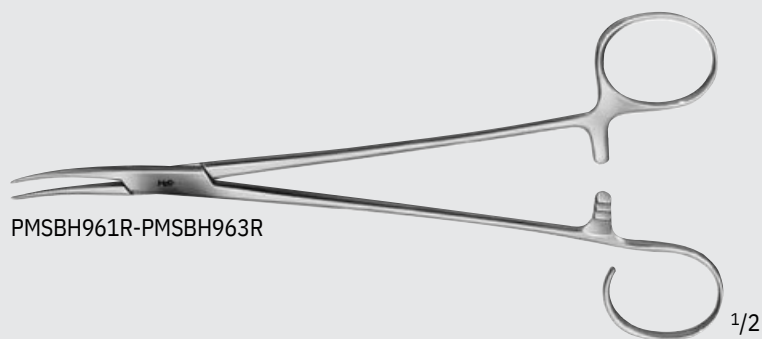
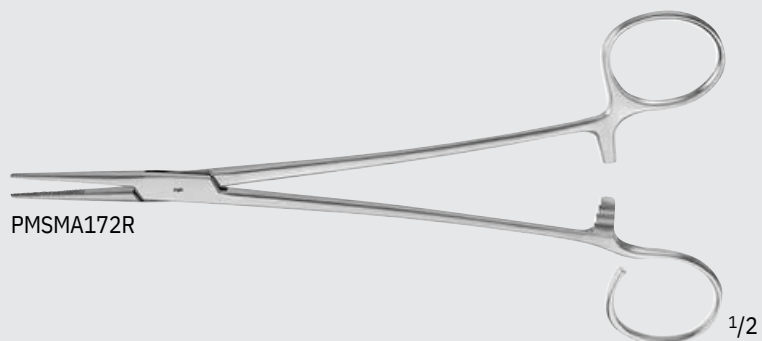

ENT ORAL

INCHES

ENT-ORAL

Clamps

Tonsil Clamp, X-long

Catalog Number	Jaw	Length (in.)
PMSMB103R	CVD	14 1/2

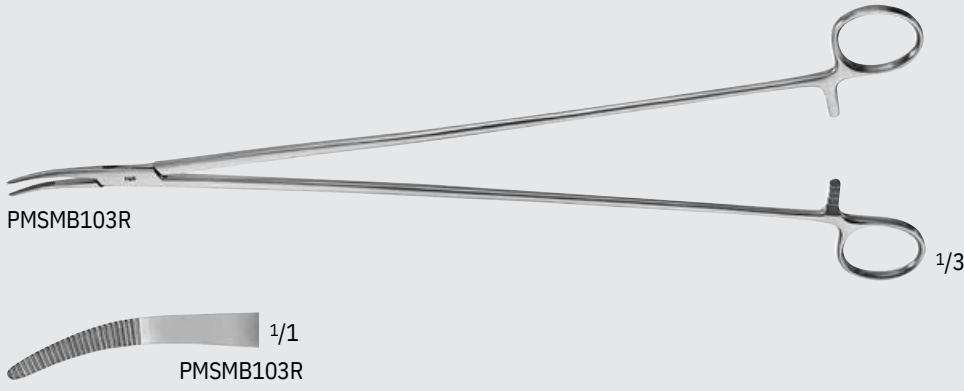

ADSON Tonsil Clamp, Delicate

Catalog Number	Jaw	Length (in.)
PMSBH200R	STR	7 1/4
PMSBH201R	CVD	7 1/4

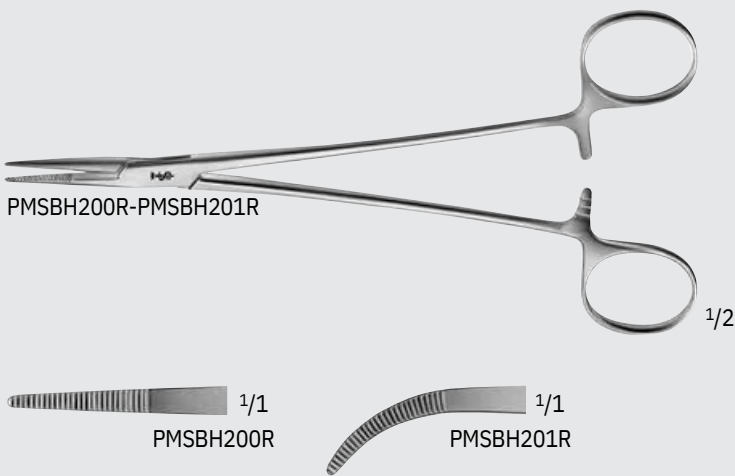

NISSEN Tonsil Clamp, Delicate

Catalog Number	Jaw	Length (in.)
PMSBH199R	CVD	7 1/4

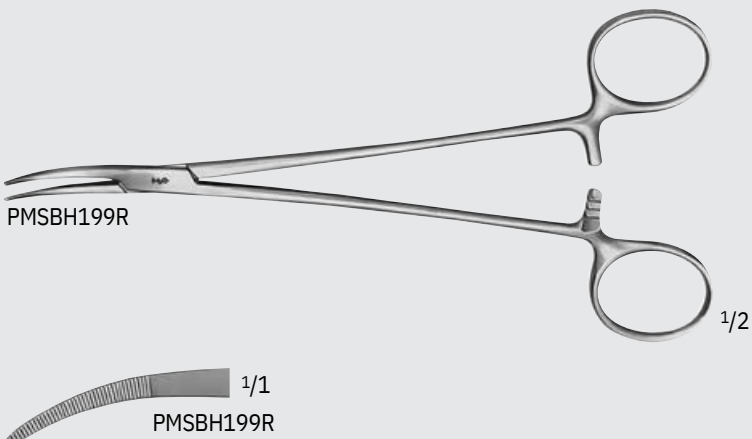

ENT
ORAL

MILLIMETERS

NEGUS Tonsil Clamp

Catalog Number	Jaw	Length (in.)
PMSBH951R	HEAVY-CVD	7 1/2
PMSBH952R	U-CVD	7 1/2

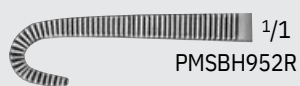
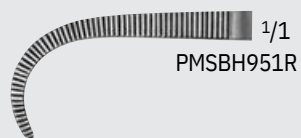
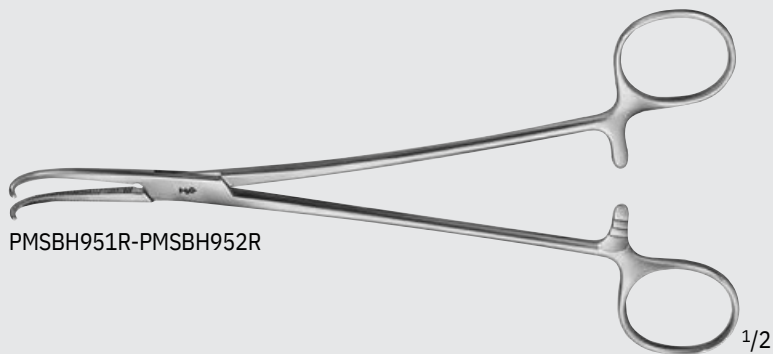

MCHENRY Tonsil Artery and Sponge Holding Clamp

Catalog Number	Jaw	Length (in.)
PMSMB533R	CVD	8

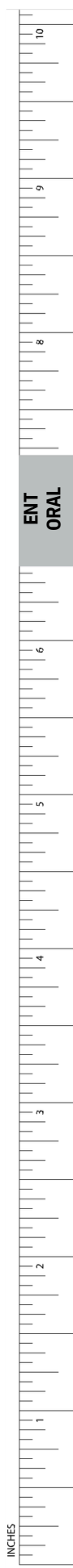
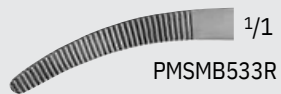
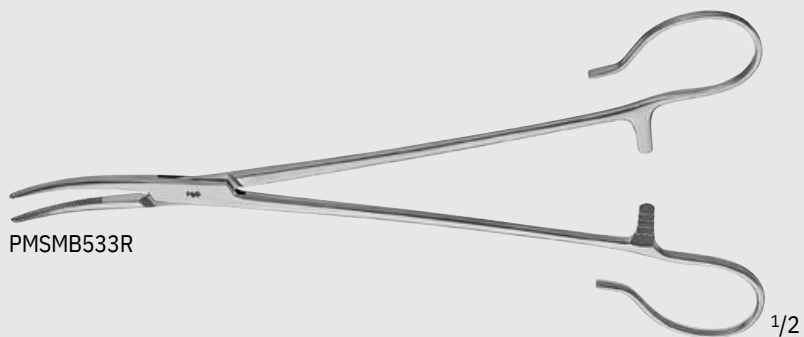

ENT-ORAL

Clamps

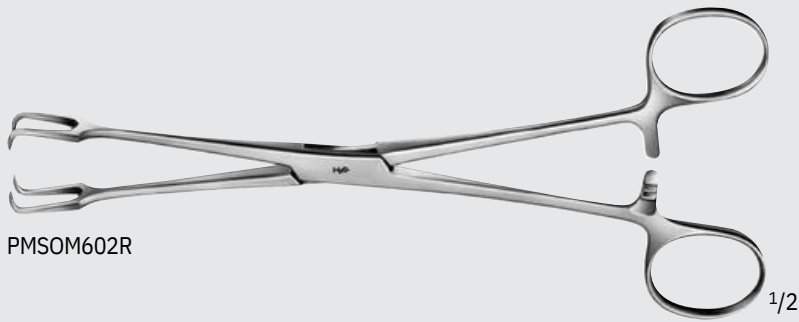

PMSOM602R

1/2

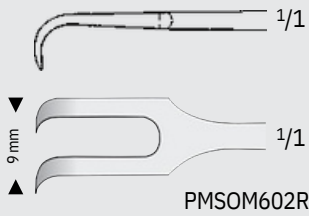

PMSOM602R

MUSEUX Tonsil Clamp

Catalog Number	Tip	Length (in.)
PMSOM602R	2 x 2	7 7/8



PMSOM612R

1/2



PMSOM612R

WHITE Tonsil Seizing Clamp

Catalog Number	Length (in.)
PMSOM612R	7
PMSOM613R	9 1/4

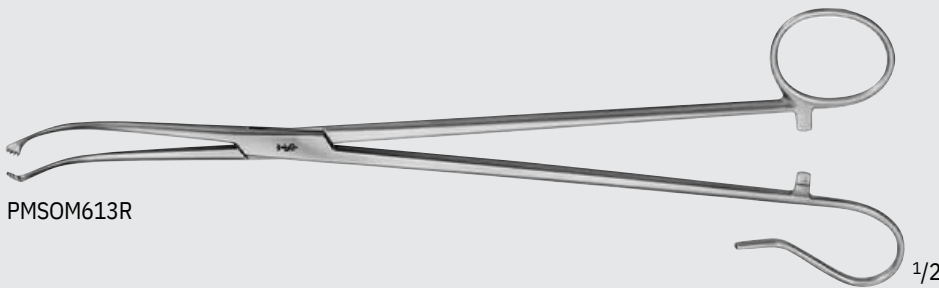

PMSOM613R

1/2

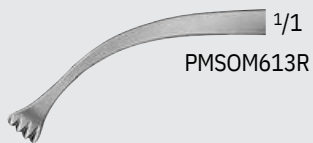

PMSOM613R

ENT ORAL



ALLIS-COAKLEY Tonsil Clamp

Catalog Number	Jaw	Length (in.)
PMSMA539R	STR	7 7/8
PMSMA540R	STRONG CVD	7 5/8

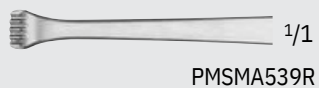
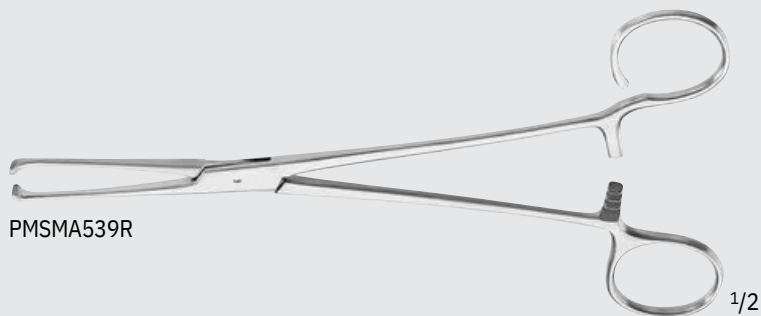

COLVER Tonsil Seizing Clamp

Catalog Number	Length (in.)
PMSOM611R	7 7/8



ENT-ORAL

Clamps

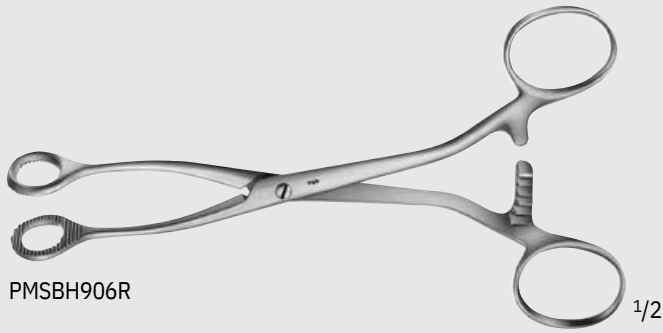

PMSBH906R

1/2

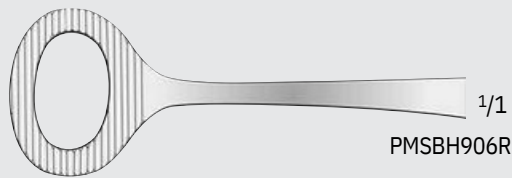

PMSBH906R

1/1

COLLIN Tongue Clamp

Catalog Number	Jaw	Length (in.)
PMSBH906R	OVAL	6 1/4

ENT
ORAL



HEYWOOD-SMITH Tongue Clamp

Catalog Number	Tip	Length (in.)
PMSAN710R	SERR	7 7/8
PMSAN711R	SERR	8 1/4

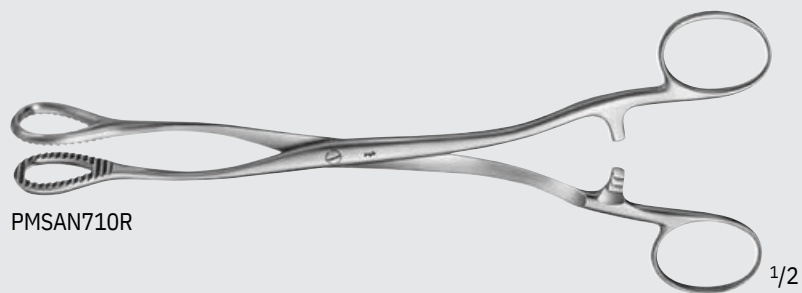

PMSAN710R

1/2

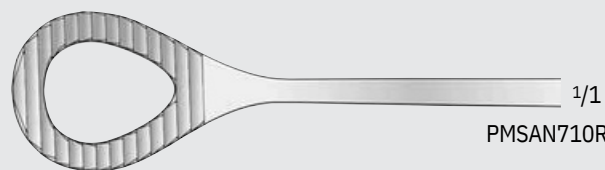

1/1

PMSAN710R

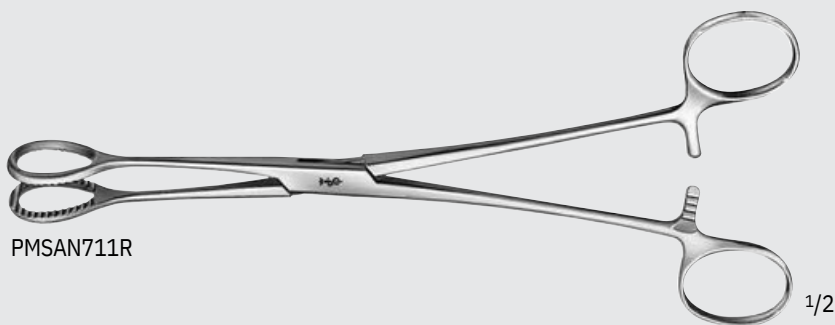

PMSAN711R

1/2

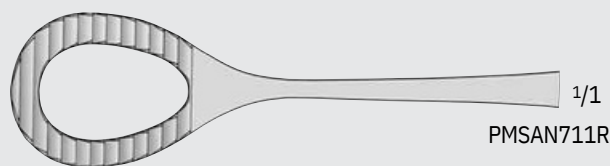

1/1

PMSAN711R



INCHES

ENT
ORAL

ENT-ORAL

Tracheal Dilators/Hooks/Retractors



PMSFA025R

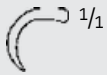

PMSFA026R



BOSE Tracheal Hook

Catalog Number	Tip	Length (in.)
PMSFA025R	CVD-LEFT	6 1/2
PMSFA026R	CVD-RIGHT	6 1/2



PMSBT103R-PMSBT107R



Tracheal Retractor

Catalog Number	Tip	Blade End	Length (in.)
PMSBT103R	SHARP	1 PRONG	7
PMSBT106R	BLUNT	1 PRONG	7
PMSBT107R	BLUNT	2 PRONGS	7

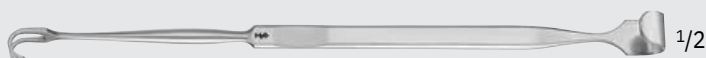

PMSMB230

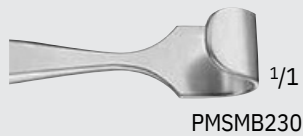

JACKSON Tracheal Retractor

Catalog Number	Length (in.)
PMSMB230	7

ENT
ORAL

MILLIMETERS



PMSFA005R

1/2

TROUSSEAU Tracheal Dilator

Catalog Number	Length (in.)
PMSFA005R	4 3/4

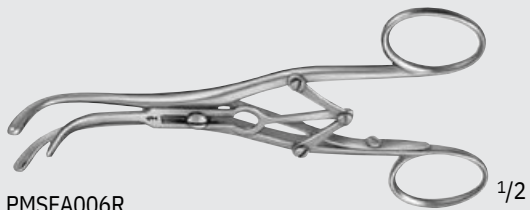

PMSFA006R

1/2

LABORDE Tracheal Dilator

Catalog Number	Length (in.)
PMSFA006R	5
PMSFA007R	5 1/4

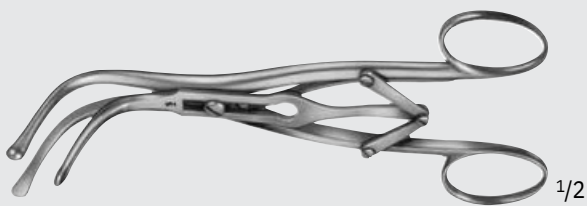

PMSFA007R

1/2



INCHES

ENT-ORAL

Retractors

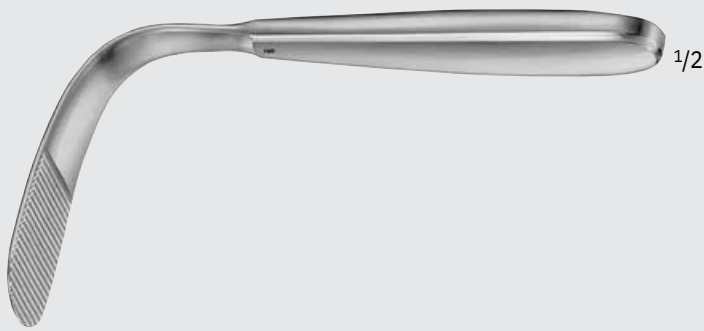

PMSOM235R

TOBOLD Tongue Depressor

Catalog Number	Length (in.)
PMSOM235R	6 1/4



PMSOM236R-PMSOM237R

WEDER Tongue Depressor

Catalog Number	Size	Length (in.)
PMSOM236R	SMALL	5
PMSOM237R	LARGE	5

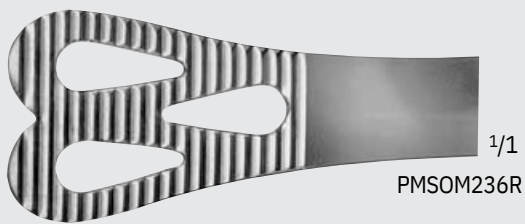

PMSOM236R

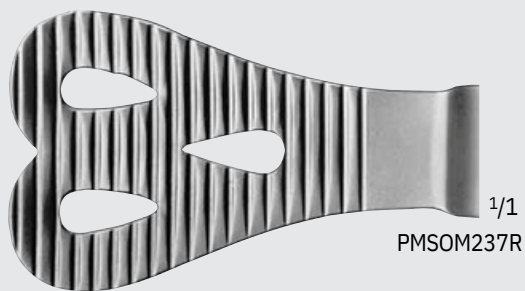

PMSOM237R

ENT
ORAL

MILLIMETERS

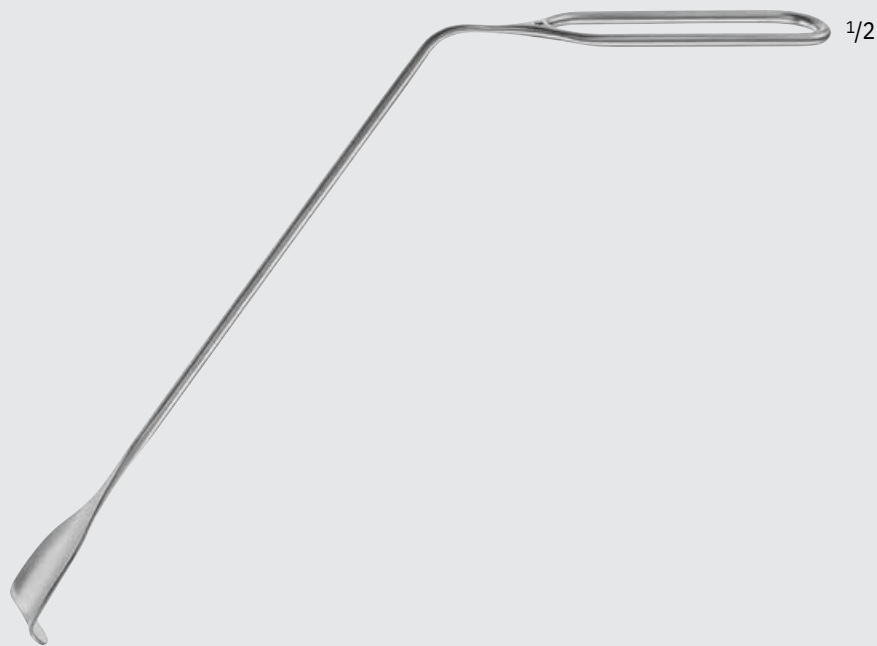

LOTHROP Uvula Retractor

Catalog Number	Blade Size (mm)	Length (in.)
PMSMA719R	17 x 20	9 5/8

PMSMA719R



PMSMA719R



GOODYEAR Uvula Retractor

Catalog Number	Blade Size (mm)	Length (in.)
PMSMA608R	15	7 3/8

PMSMA608R



LAHEY Goiter Retractor

Catalog Number	Blade Size (mm)	Length (in.)
PMSMB785R	24 x 8	7 7/8

PMSMB785R



PMSMB785R

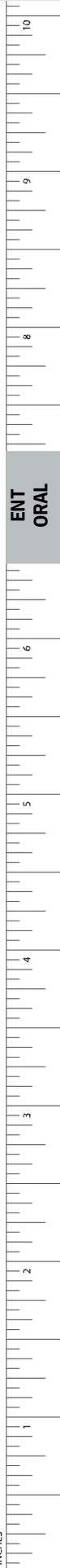

INCHES

ENT-ORAL

Retractors



PMSMA434R-PMSMA437R

SEWALL Orbital Retractor

Catalog Number	Blade Size (mm)	Length (in.)
PMSMA434R	7 x 52	6 3/4
PMSMA435R	9 x 44	6 3/8
PMSMA436R	11 x 50	6 3/8
PMSMA437R	13 x 67	6 3/4

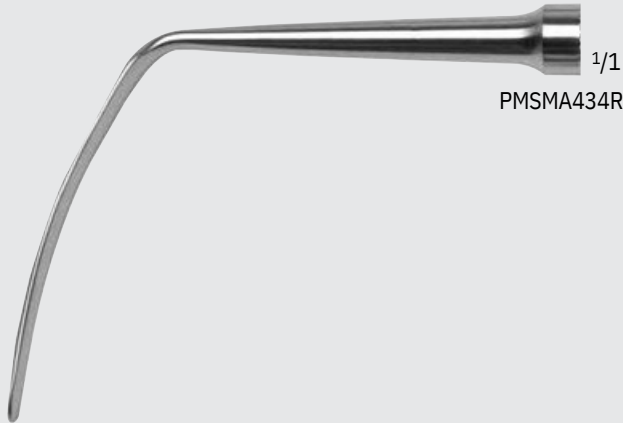

PMSMA434R 1/1



PMSMA435R 1/1



PMSMA436R 1/1

ENT
ORAL



HURD Tonsil Dissector / Pillar Retractor

Catalog Number	Tip Size (mm)	Length (in.)
PMSOM660R	6	8 1/2
PMSOM661R	10	8 1/2

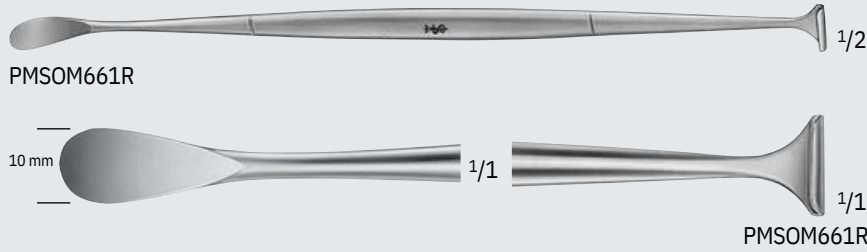
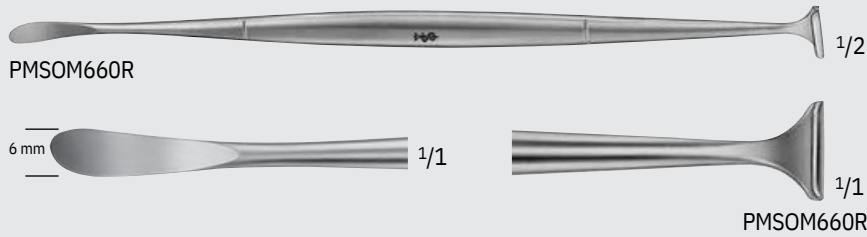

HENKE Tonsil Dissector

Catalog Number	Tip Size (mm)	Length (in.)
PMSOM668R	12	9 1/4

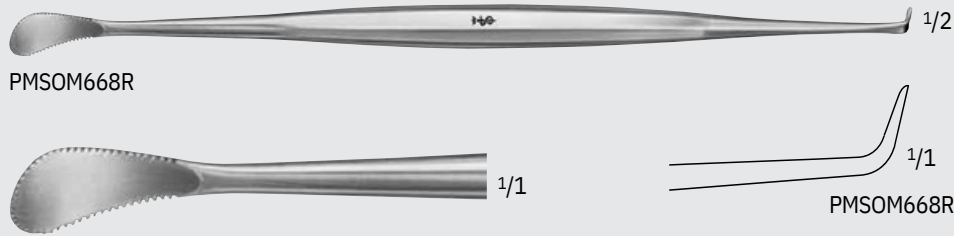

LOTHROP Tonsil Knife and Dissector

Catalog Number	Length (in.)
PMSMA289R	8 1/4

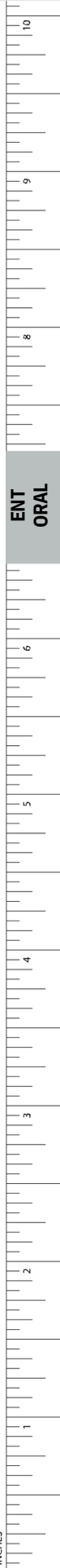

ENT-ORAL

Adenotomes/Tonsil Snares/Wires



PMSOM391R-
PMSOM398R

LA FORCE Adenotome

Catalog Number	Size (#)	Description	Length (in.)
PMSOM391R	1	-	9 1/4
PMSOM392R	2	-	9 1/4
PMSOM393R	3	-	9 1/4
PMSOM396R	-	SPARE BLADE F/ OM391R	-
PMSOM397R	-	SPARE BLADE F/ OM392R	-
PMSOM398R	-	SPARE BLADE F/ OM393R	-



PMSOM396R



1/1



PMSOM397R



1/1



PMSOM398R



1/1

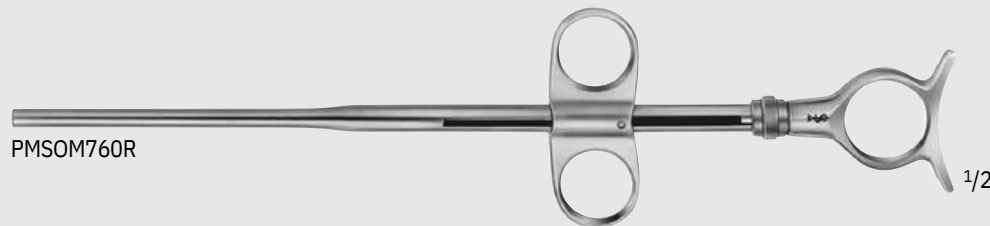

PMSOM760R

1/2



PMSOM761R

1/2

EVES Tonsil Snare W/ 25 Gauge Wire

Catalog Number	Description	Length (in.)
PMSOM760R	W/O RATCHET	9 3/4
PMSOM761R	W/ RATCHET	9 3/4

ENT
ORAL

MILLIMETERS

LEWIS Tonsil Snare

Catalog Number	Description	Length (in.)
PMSMA714R	INCLUDES 12 #8 SNARE WIRES	10 1/4

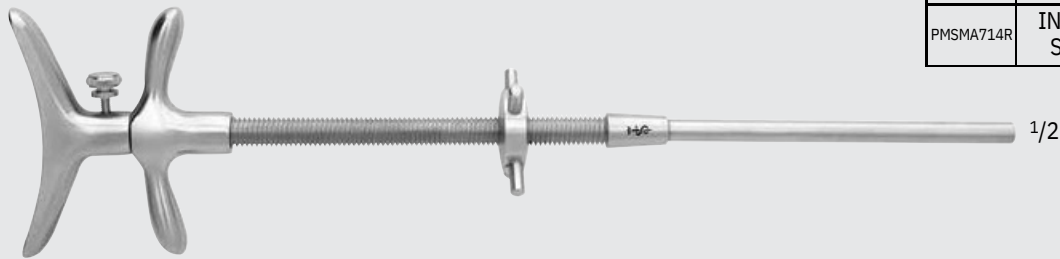

PMSMA714R

SAGE Tonsil Snare

Catalog Number	Description	Length (in.)
PMSMA493R	W/ SNARE WIRES	11
PMSMA490R	12 #6 SNARE WIRES	4

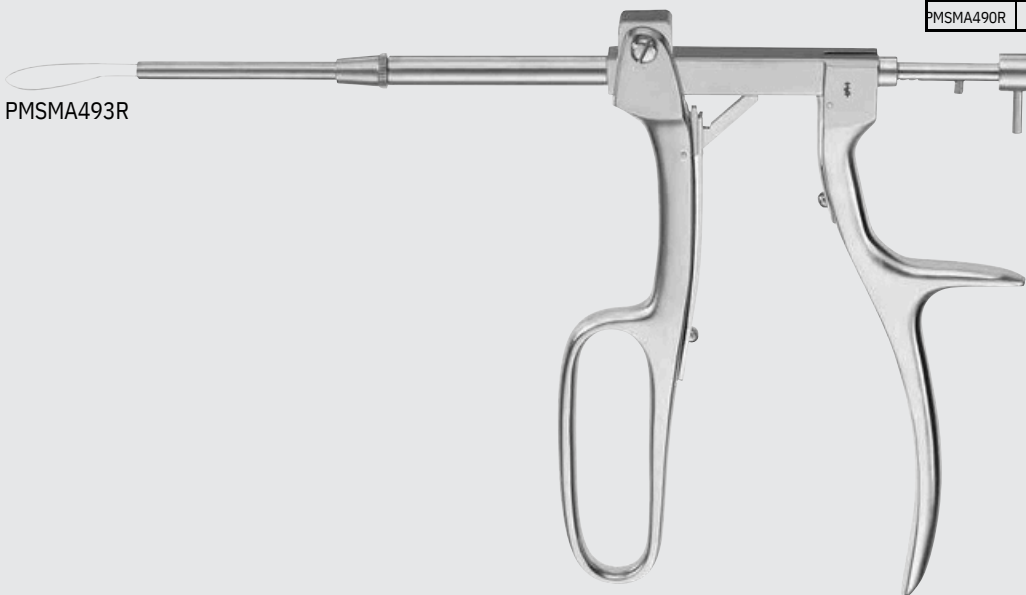

PMSMA493R

1/2



PMSMA490R

1/4



ENT-ORAL

Tonsil Snares/Wires/Adenotomes

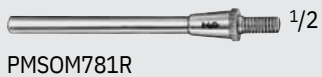
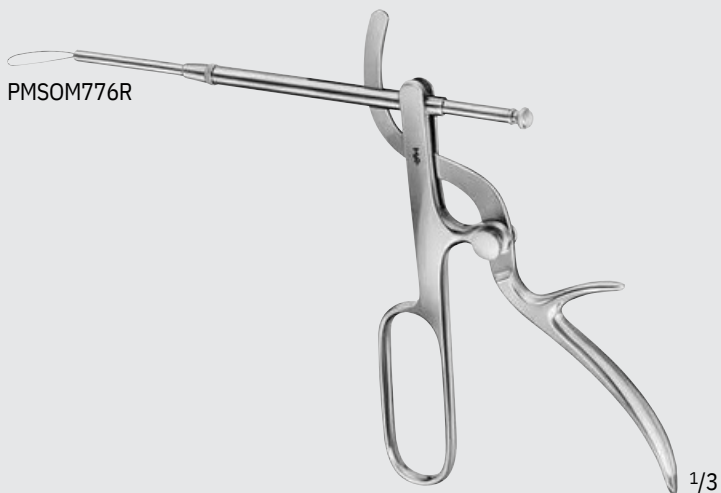

TYDING Tonsil Snare

Catalog Number	Description
PMSOM781R	-
PMSOM776R	TIP ONLY, STR

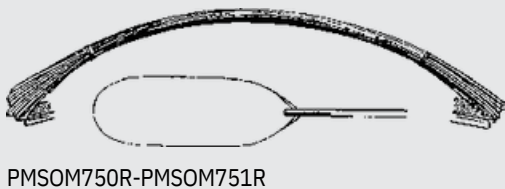

Tonsil Snare Wire

Catalog Number	Diameter (mm)	Size (#)	Sales Unit	Length (mm)
PMSMA490R	1.4	6	12/BOX	100
PMSOM750R	0.3	7	12/BOX	100
PMSOM751R	0.5	8	12/BOX	100



ENT
ORAL



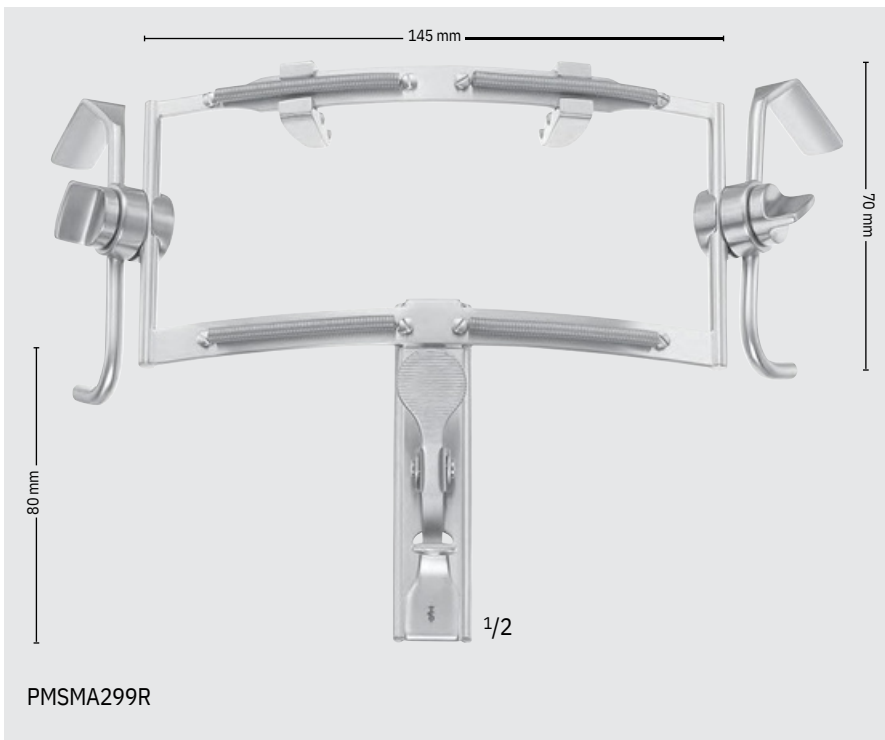

DINGMAN Mouth Gag

Catalog Number	Description
PMSMA299R	COMPLETE SET WITH 3 BLADES AND FRAME

PMSMA299R Includes:

- 1 Mouth Gag PMSOM105R,
- 1 Blade of each PMSOM171R, PMSOM172R, PMSOM177R

PMSMA299R

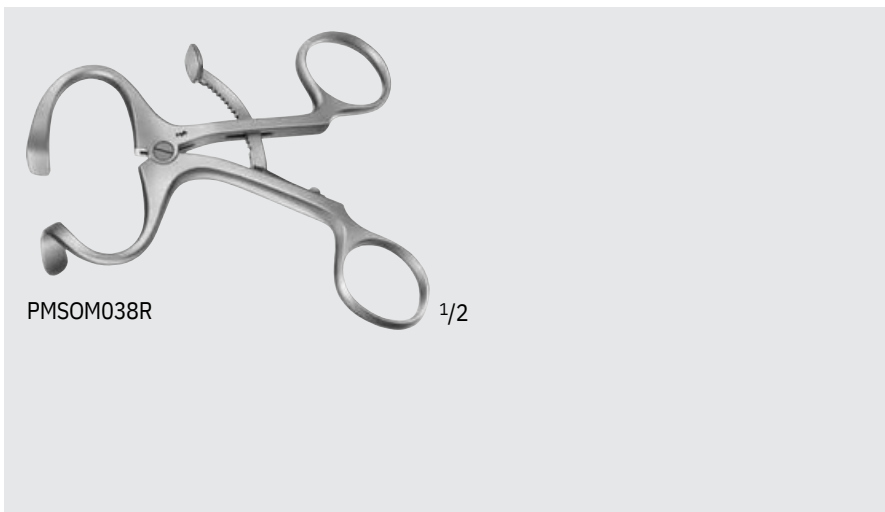

MOLT Mouth Gag, Pediatric

Catalog Number	Description	Length (in.)	Length (m)
PMSOM038R	-	4	-
PMSTA009706	SPARE SILICONE TUBE ONLY, LATEX-FREE	-	1

PMSTA009706 Protective covers for PMSOM038R and PMSOM040R available as silicone tubing which may be cut to length

PMSOM038R

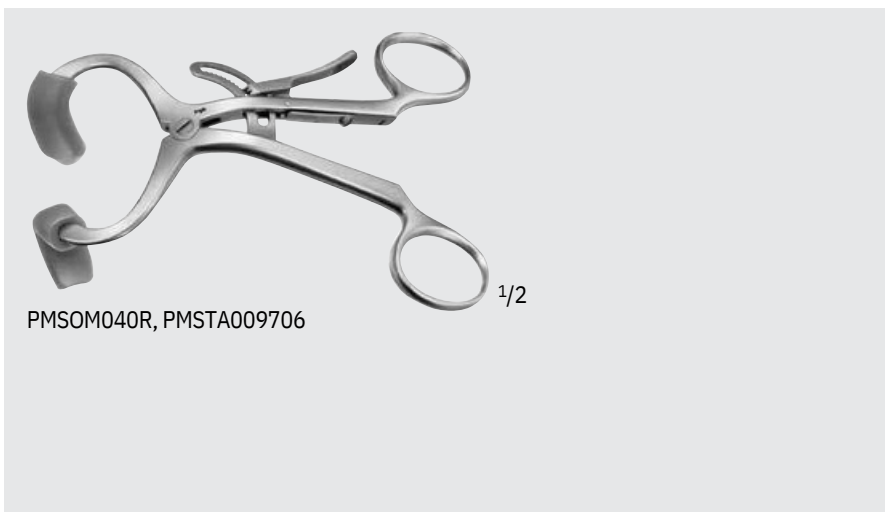

DOYEN-COLLIN Mouth Gag

Catalog Number	Description	Length (in.)	Length (m)
PMSOM040R	-	4 3/4	-
PMSTA009706	SPARE SILICONE TUBE ONLY, LATEX-FREE	-	1

PMSTA009706 Protective covers for PMSOM038R and PMSOM040R available as silicone tubing which may be cut to length

PMSOM040R, PMSTA009706

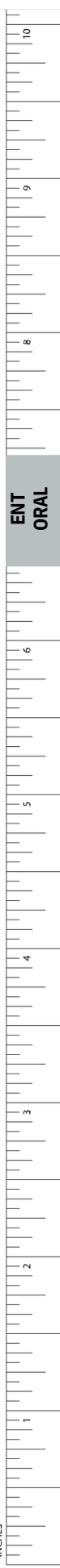

ENT-ORAL

Mouth Gags



PMSOM041R, PMSTA005771 1/2

DOYEN-JANSEN Mouth Gag

Catalog Number	Description	Length (in.)	Length (m)
PMSOM041R	-	5 1/2	-
PMSTA005771	SPARE SILICONE TUBE ONLY, LATEX-FREE	-	1

PMSTA005771 Protective covers for PMSOM041R available as silicone tubing which may be cut to length



PMSOM047R

DENHARDT Mouth Gag

Catalog Number	Length (in.)
PMSOM047R	5



PMSOM070R-PMSOM073R

WHITEHEAD-JENNINGS Mouth Gag

Catalog Number	Length (in.)
PMSOM070R	3 1/2
PMSOM071R	4 1/4
PMSOM072R	5 1/8
PMSOM073R	6



PMSOP299

Teeth Protector, Latex-Free Rubber

Catalog Number	Size
PMSOP299	ADOLESCENT AND ADULT

DAVIS Mouth Gag

Catalog Number	Blade Size (mm)	Size (#)	Description	Length (in.)
PMSMA302R	-	-	COMPLETE SET, RIGHT	-
PMSMA303R	-	-	COMPLETE SET, LEFT	-
PMSMA307R	-	-	RIGHT FRAME ONLY	6
PMSMA304R	20 x 34	1	BLADE	5 1/4
PMSMA305R	23 x 64	2	BLADE	5 1/4
PMSMA306R	25 x 79	3	BLADE	5 1/4
PMSMA308R	25 x 85	3 1/2	BLADE	5 1/8
PMSMA309R	25 x 95	4	BLADE	5 1/8
PMSMA310R	25 x 106	5	BLADE	5 1/8
PMSOM170	SILICONE INSERT			

PMSMA302R Includes:

1 Blades w/ Tube of each PMSMA304R, PMSMA307R, PMSOM112R, PMSMA315R, PMSOM114R, PMSOM115R

PMSMA303R Includes:

1 Blades w/ Tube of each PMSOM116R, PMSMA304R, PMSOM112R, PMSMA315R, PMSOM114R, PMSOM115R



PMSMA307R



PMSMA304R



PMSMA305R



PMSMA306R



PMSMA308R

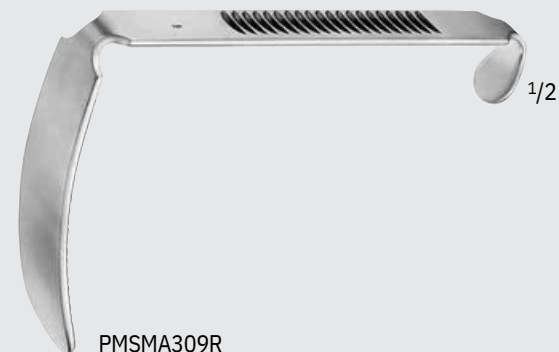

PMSMA309R



PMSMA310R

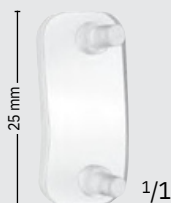

PMSOM170



INCHES

ENT-ORAL

Mouth Gags



PMSMA315R



PMSMA319R

DAVIS Mouth Gag W/ Tube

Catalog Number	Blade Size (mm)	Size (#)
PMSMA315R	24 x 80	3
PMSMA319R	25 x 90	3



DAVIS-BOYLE Mouth Gag

Catalog Number	Blade Size (mm)	Size	Description	Length (in.)
PMSOM118R	-	CHILD	FRAME ONLY	5 1/4
PMSOM119R	-	TEEN	FRAME ONLY	5 3/4
PMSOM116R	-	ADULT	FRAME ONLY	6 3/4
PMSOM112R	25 x 62	-	BLADE	-
PMSOM113R	25 x 75	-	BLADE	-
PMSOM114R	25 x 92	-	BLADE	-
PMSOM115R	25 x 108	-	BLADE	-
PMSOM170	SILICONE INSERT			



PMSOM118R



PMSOM119R



PMSOM116R



PMSOM112R-PMSOM115R

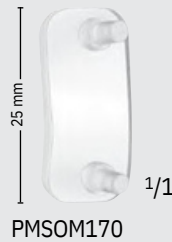

PMSOM170



PMSOM112R



PMSOM113R



PMSOM114R



PMSOM115R

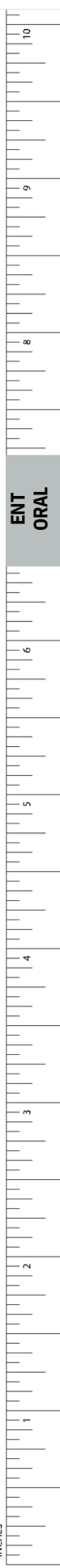

ENT-ORAL

Mouth Gags



PMSOM169R



1/1



1/1

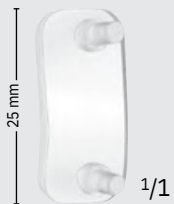

PMSOM170



1/2

PMSOM179R

DAVIS-MEYER Tongue Depressor Frame

Catalog Number	Description
PMSOM169R	FRAME, COMPLETE
PMSOM170	SILICONE INSERT
PMSOM179R	PALATE BLADE

ENT
ORAL

MILLIMETERS

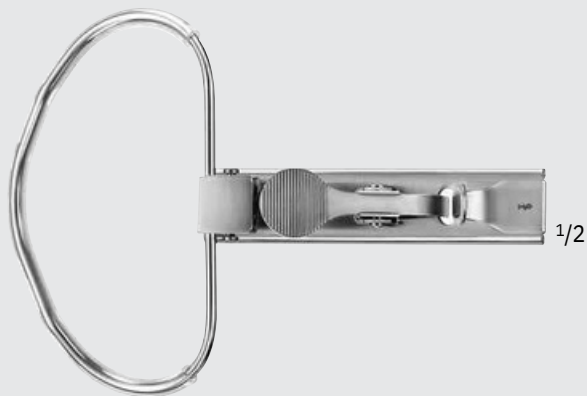

PMSMA311R



PMSMA312R-PMSMA314R

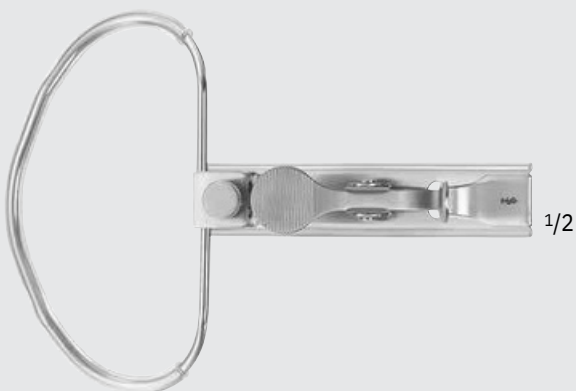

PMSOM104R



PMSMB595R-PMSMB600R

MCIVOR Mouth Gag

Catalog Number	Blade Size (mm)	Size (#)	Description	Length (in.)
PMSMA311R	-	-	COMPLETE WITH FRAME AND 3 TONGUE BLADES	-
PMSMA312R	22 x 69	1	BLADE	5 3/8
PMSMA313R	24 x 90	2	BLADE	5 3/8
PMSMA314R	25 x 100	3	BLADE	5 3/8
PMS OM104R	-	-	FRAME F/ TONGUE DEPRESSOR	5 1/2
PMSOM104201	-	-	REPLACEMENT TUBE F/ OM104R	-
PMSOM101R	25 x 55	-	BLADE	-
PMSOM102R	25 x 62	-	BLADE	-
PMSOM103R	25 x 75	-	BLADE	-
PMSMB595R	57 x 23	2	BLADE, RIGHT	-
PMSMB596R	72 x 27	3	BLADE, RIGHT	-
PMSMB597R	88 x 33	4	BLADE, RIGHT	-
PMSMB598R	57 x 23	2	BLADE, LEFT	-
PMSMB599R	72 x 27	3	BLADE, LEFT	-
PMSMB600R	88 x 33	4	BLADE, LEFT	-
PMSMA301R	97 x 36	5	BLADE, LEFT	-
PMSMA300R	97 x 36	5	BLADE, RIGHT	-

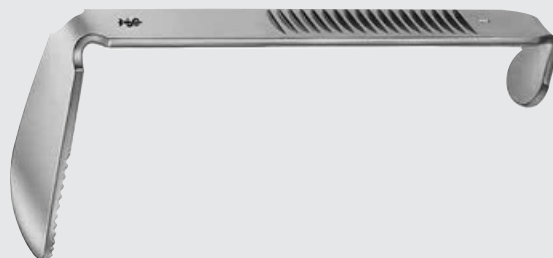

PMSOM101R-PMSOM103R



PMSMA300R-PMSMA301R



INCHES

ENT-ORAL

Mouth Gags



PMSOM171R-PMSOM178R

RUSSEL-DAVIS Tongue Blade

Catalog Number	Blade Size (mm)
PMSOM171R	29 x 67
PMSOM172R	33 x 75
PMSOM173R	38 x 85
PMSOM174R	40 x 92
PMSOM175R	46 x 100
PMSOM176R	18 x 57
PMSOM177R	22 x 67
PMSOM178R	25 x 75



PMSOM171R



PMSOM172R



PMSOM173R



PMSOM174R



PMSOM175R



PMSOM176R



PMSOM177R



PMSOM178R

ENT
ORAL

MILLIMETERS



PMSOM181R-PMSOM183R

GAST Tongue Blade

Catalog Number	Blade Size (mm)
PMSOM181R	28 x 64
PMSOM182R	34 x 74
PMSOM183R	38 x 87



PMSOM181R



PMSOM182R

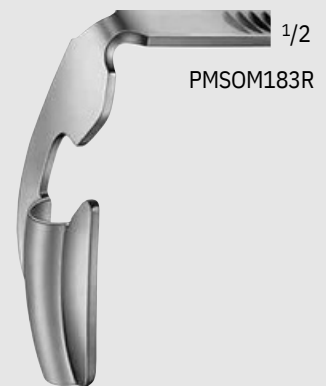

PMSOM183R

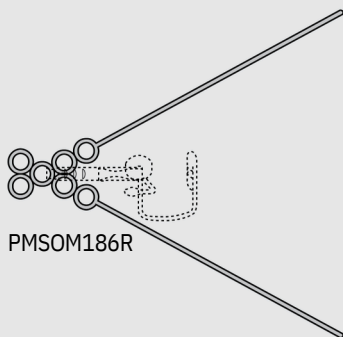

PMSOM186R

DRAFFIN Chest Support, W/ 4 Height Rings

Catalog Number	Length (in.)
PMSOM186R	18 7/8

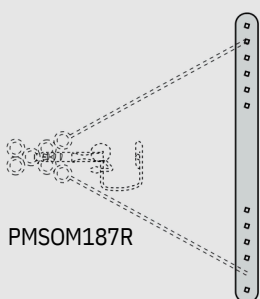

PMSOM187R

MAGAUARAN Plate, F/ Holding OM186R

Catalog Number	Length (in.)
PMSOM187R	16

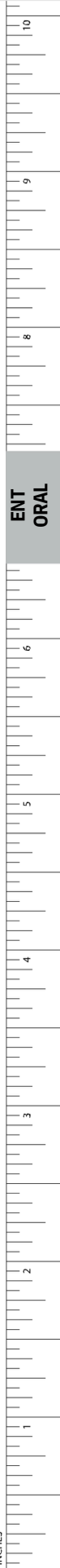

ENT-ORAL

Tonsil Knives



PMSOM681R

ABRAHAM Tonsil Knife

Catalog Number	Length (in.)
PMSOM681R	8 3/4



PMSOM681R



PMSOM688R

FISHER Tonsil Knife

Catalog Number	Length (in.)
PMSOM688R	8



PMSOM688R

ENT
ORAL



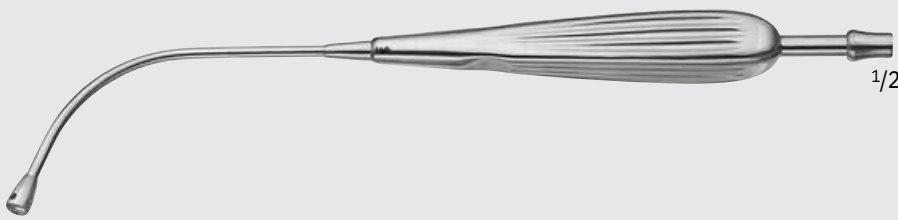

ANDREWS Pynchon Suction Tube

Catalog Number	Description	Length (in.)
PMSMD613	-	9
PMSMD613001	TIP ONLY F/ MD613	-

PMSMD613



PMSMD613001

PMSOP360R-PMSOP362R

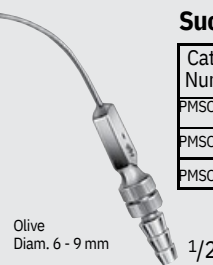

Suction Tube, W/ Finger Cut-O

Catalog Number	Tip Size (mm)	Working Length (in.)
PMSOP360R	2.0	9 3/4
PMSOP361R	2.5	9 3/4
PMSOP362R	3.0	9 3/4

Olive
Diam. 6 - 9 mm

PMSMB366R-PMSMB369R

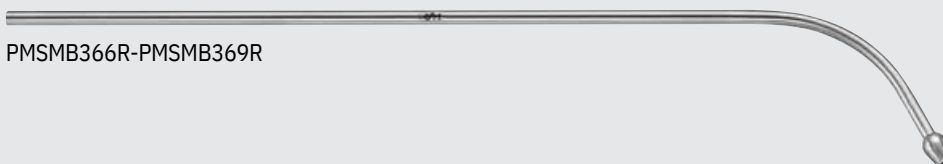

JACKSON Velvet Eye Aspirating Tube

Catalog Number	Diameter (mm)	Length (in.)
PMSMB366R	4.0	10
PMSMB367R	4.0	16 3/8
PMSMB368R	4.0	22
PMSMB369R	4.0	18 1/8

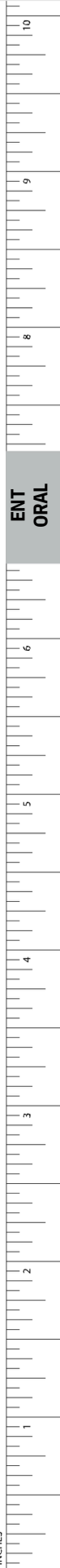

ENT-ORAL

Curettes



PMSOM471R-PMSOM474R

BARNHILL Adenoid Curette

Catalog Number	Tip Size (mm)	Length (in.)
PMSOM471R	11	7 7/8
PMSOM472R	13	7 7/8
PMSOM473R	15	7 7/8
PMSOM474R	17	7 7/8



PMSOM471R

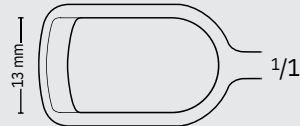

PMSOM472R



PMSOM473R

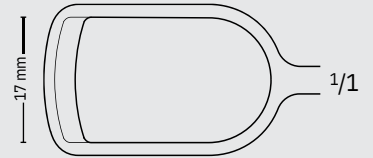

PMSOM474R



PMSOM451R-PMSOM456R

BECKMANN Adenoid Curette

Catalog Number	Tip Size (mm)	Length (in.)
PMSOM451R	9.25	7 7/8
PMSOM452R	11.5	7 7/8
PMSOM453R	12	7 7/8
PMSOM454R	13	7 7/8
PMSOM455R	15.5	7 7/8
PMSOM456R	16	7 7/8
PMSOM500R	10	8 3/4
PMSOM501R	12	8 3/4
PMSOM502R	14	8 3/4
PMSOM503R	16	8 3/4
PMSOM504R	18	8 3/4
PMSOM505R	20	8 3/4

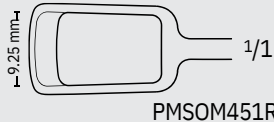

PMSOM451R



PMSOM452R

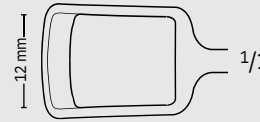

PMSOM453R

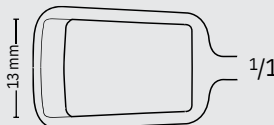

PMSOM454R

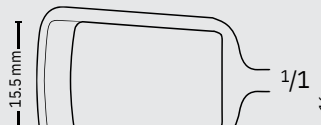

PMSOM455R



PMSOM456R



PMSOM500R-PMSOM505R



PMSOM500R



PMSOM501R



PMSOM502R

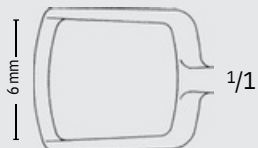

PMSOM503R



PMSOM504R



PMSOM505R

ENT
ORAL



PMSMA654R-PMSMA656R

JONES Adenoid Curette

Catalog Number	Tip Size (mm)	Size (#)	Size	Length (in.)
PMSMA656R	4	1	INFANT	8 3/4
PMSMA655R	6	2	CHILD	8 7/8
PMSMA654R	8	3	ADULT	8 7/8



PMSMA656R



PMSMA655R



PMSMA654R



PMSMA291R

MIDDLETON Adenoid Curette

Catalog Number	Tip Size (mm)	Length (in.)
PMSMA291R	7	8 7/8



PMSMA291R



PMSOM510R-PMSOM514R

NEGUS Adenoid Curette

Catalog Number	Tip Size (mm)	Length (in.)
PMSOM510R	10	7 7/8
PMSOM511R	12.25	7 7/8
PMSOM512R	14	7 7/8
PMSOM513R	16.5	7 7/8
PMSOM514R	18	7 7/8

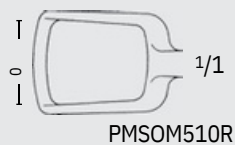

PMSOM510R

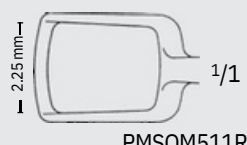

PMSOM511R

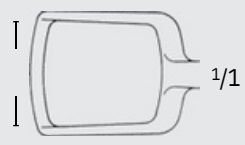

PMSOM512R



PMSOM513R

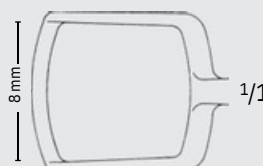

PMSOM514R

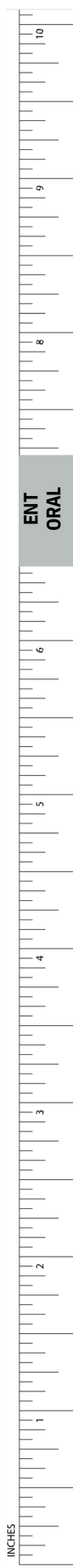

ENT ORAL

INCHES

ENT-ORAL

Curettes



PMSUS149-PMSUS150

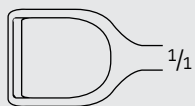

PMSUS149

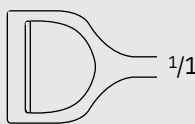

PMSUS150



PMSMA066R-PMSMA067R

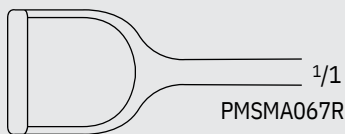

PMSMA067R

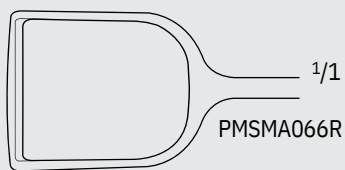

PMSMA066R

STUBBS Adenoid Curette

Catalog Number	Tip Size (mm)	Size (#)	Length (in.)
PMSUS149	11	0	8 1/2
PMSUS150	14	1	8 1/2
PMSMA067R	16	2	8 1/2
PMSMA066R	18	3	8 1/2



PMSMB316R



PMSMB316R

VOGEL Adenoid Curette, Infant

Catalog Number	Tip Size (mm)	Length (in.)
PMSMB316R	7	8 1/2

ENT
ORAL

MILLIMETERS

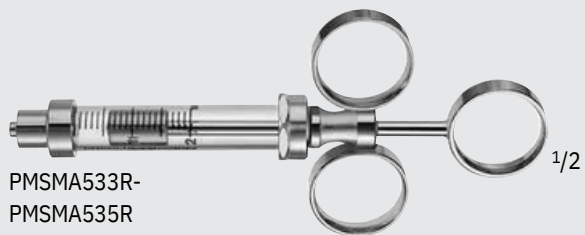

Syringe

Catalog Number	Diameter (mm)	Volume (cc)	Length (in.)
PMSMA533R	11	3	5 1/2
PMSMA534R	14	5	5 1/2
PMSMA535R	17	10	5 1/2



ENT-ORAL

Laryngeal Mirrors

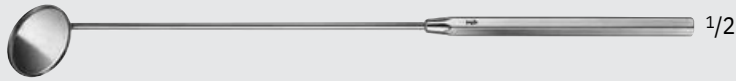

PMSOM078R-PMSOM090R

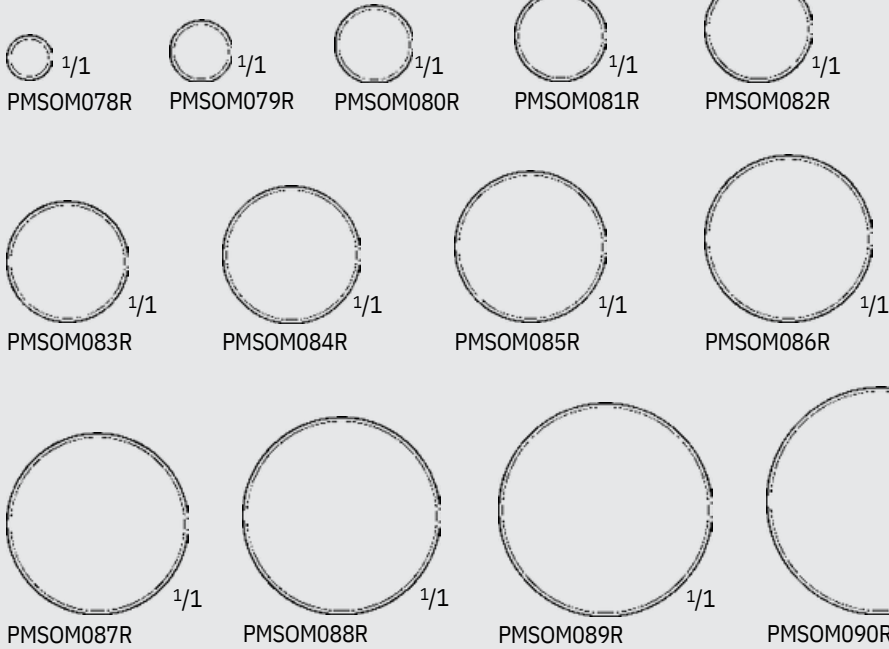

Laryngeal Mirror, Rigid, W/ Hex Handle

Catalog Number	Size (#)	Diameter (mm)	Length (in.)
PMSOM078R	000	6.0	7
PMSOM079R	00	8.0	7
PMSOM080R	0	10.0	7
PMSOM081R	1	12.0	7
PMSOM082R	2	14.0	7
PMSOM083R	3	16.0	7
PMSOM084R	4	18.0	7
PMSOM085R	5	20.0	7
PMSOM086R	6	22.0	7
PMSOM087R	7	24.0	7
PMSOM088R	8	26.0	7
PMSOM089R	9	28.0	7
PMSOM090R	10	30.0	7

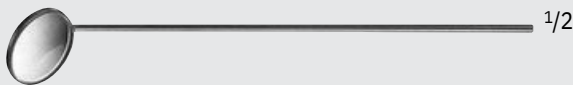

PMSAC468R-PMSAC480R



PMSAC481R

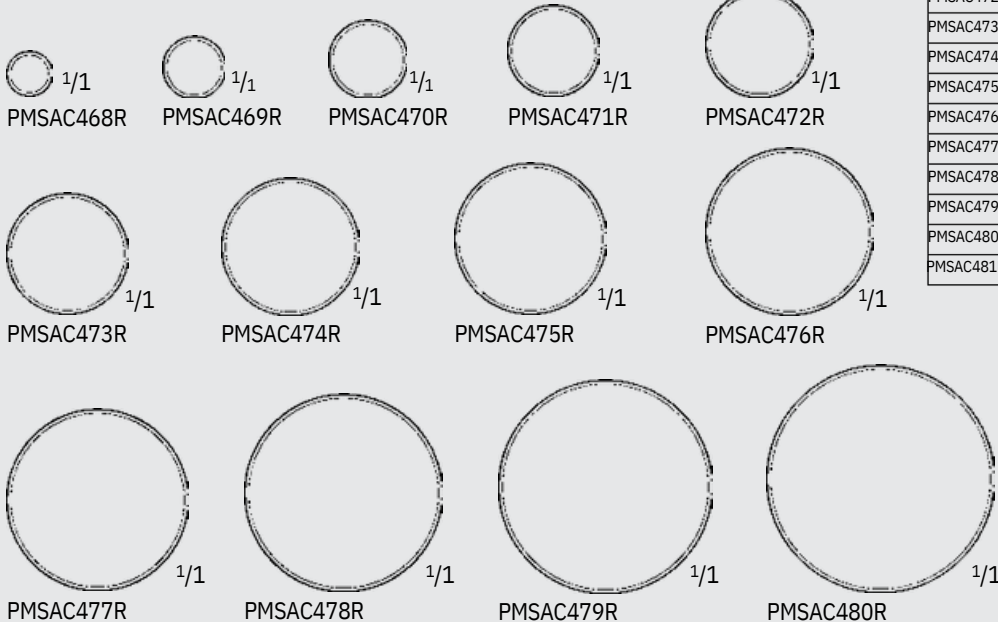

Laryngeal Mirror, Rigid, F/ Handle AC481R

Catalog Number	Size (#)	Diameter (mm)	Length (in.)
PMSAC468R	000	6.0	4 3/4
PMSAC469R	00	8.0	4 3/4
PMSAC470R	0	10.0	4 3/4
PMSAC471R	1	12.0	4 3/4
PMSAC472R	2	15.0	4 3/4
PMSAC473R	3	16.0	4 3/4
PMSAC474R	4	18.0	4 3/4
PMSAC475R	5	20.0	4 3/4
PMSAC476R	6	22.0	4 3/4
PMSAC477R	7	24.0	4 3/4
PMSAC478R	8	26.0	4 3/4
PMSAC479R	9	28.0	4 3/4
PMSAC480R	10	30.0	4 3/4
PMSAC481R	-	HANDLE	4 1/4

ENT
ORAL

MILLIMETERS



PMSG574R

Amalgam Carrier, Double Ended

Catalog Number	Size	Length (in.)
PMSG574R	MEDIUM / LARGE	7 7/8

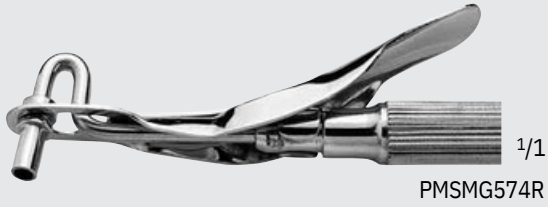

PMSG574R

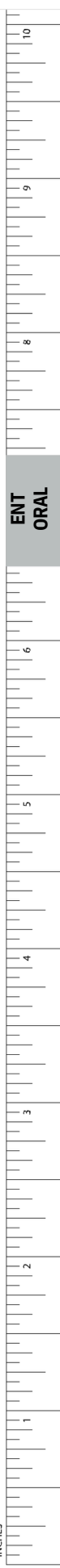

INCHES



PARKER MEDICAL SUPPLIES

CONTACT US



+1 (832) 343-3140



info@parkermedicalsupplies.com



www.parkermedicalsupplies.com

VISIT US:

2800 Post Oak Blvd, Ste 5600, Houston TX 77056, United States