



# PARKER MEDICAL SUPPLIES



## PMS OBSTETRICS/GYNECOLOGY SURGICAL INSTRUMENTS

# Product Catalog



+1 (832) 343-3140



[info@parkermedicalsupplies.com](mailto:info@parkermedicalsupplies.com)



[www.parkermedicalsupplies.com](http://www.parkermedicalsupplies.com)

2800 Post Oak Blvd, Ste 5600, Houston TX 77056, United States





## Obstetrics/Gynecology

Scissors .....	1202 - 1211
Needle Holders .....	1212
Forceps .....	1213 - 1250
Clamps .....	1251 - 1260
Retractors .....	1261 - 1262
Vaginal Retractors and Specula .....	1263 - 1281
Endospecula .....	1282
Dilators and Probes .....	1283 - 1287
Curettes .....	1288 - 1294
Accessories .....	1295

# Obstetrics/Gynecology

## Scissors

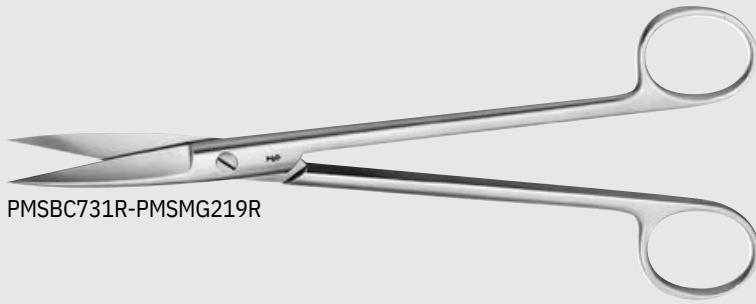

PMSBC731R-PMSMG219R

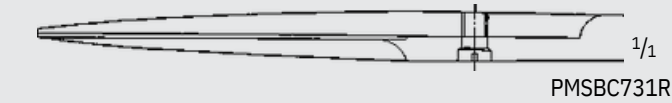

PMSBC731R

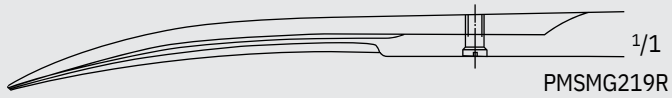

PMSMG219R

### SIMS Scissors

Catalog Number	Tip	Blade	Length (in.)
PMSBC731R	S/S	STR	7 7/8
PMSMG219R	S/S	CVD	8

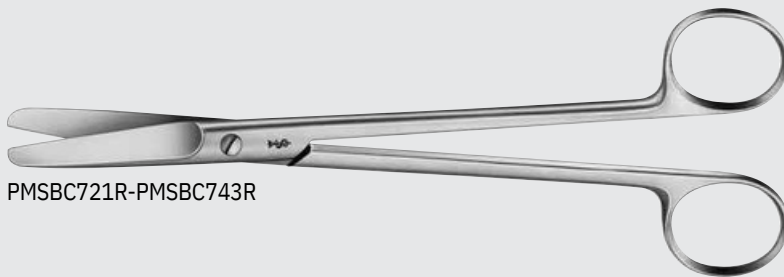

PMSBC721R-PMSBC743R



PMSBC721R

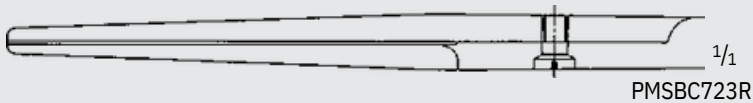

PMSBC723R



PMSBC741R

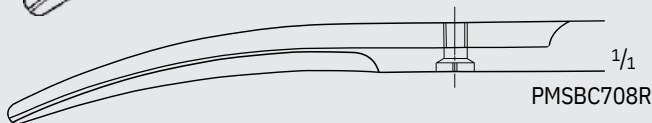

PMSBC708R

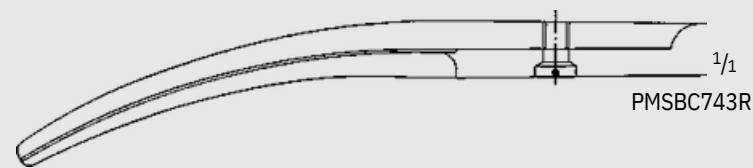

PMSBC743R

### SIMS Scissors

Catalog Number	Tip	Blade	Length (in.)
PMSBC721R	B/B	STR	7 7/8
PMSBC723R	B/B	STR	9
PMSBC741R	B/B	CVD	7 7/8
PMSBC708R	B/B	CVD	8 1/4
PMSBC743R	B/B	CVD	9

OB/GYN

MILLIMETERS

**SIMS Scissors (continued)**

Catalog Number	Tip	Blade	Length (in.)
PMSMG218R	S/B	STR	8
PMSBC746R	S/B	CVD	7 7/8
PMSBC748R	S/B	CVD	9

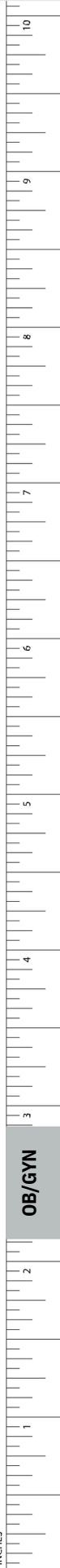
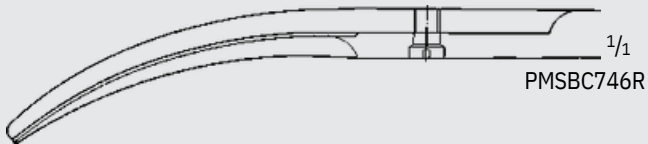
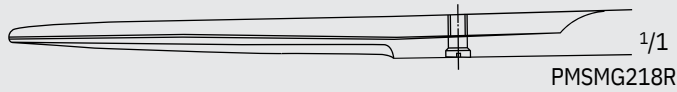
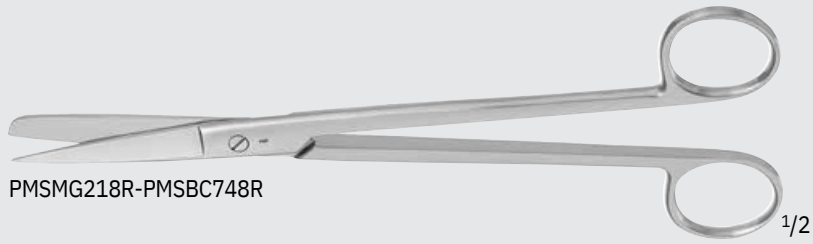

OB/GYN

INCHES

# Obstetrics/Gynecology

## Scissors



PMSBC702R-PMSBC704R

### WERTHEIM Scissors

Catalog Number	Tip	Blade	Length (in.)
PMSBC702R	B/B	CVD	5 3/4
PMSBC703R	B/B	CVD	7 7/8
PMSBC704R	B/B	CVD	9



PMSBC702R



PMSBC703R



PMSBC704R

OB/GYN

MILLIMETERS

**JORGENSEN Scissors**

Catalog Number	Tip	Blade	Length (in.)
PMSMD491	B/B	CVD	8 3/4

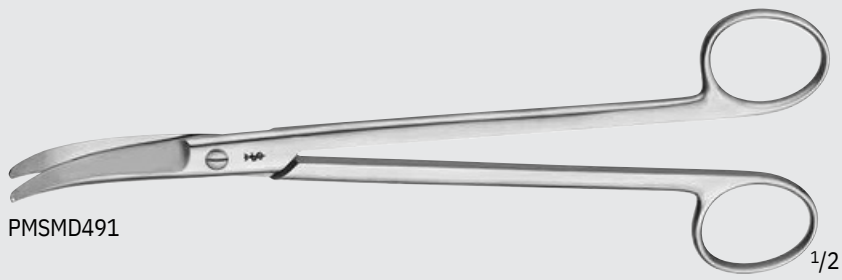

PMSMD491

1/2

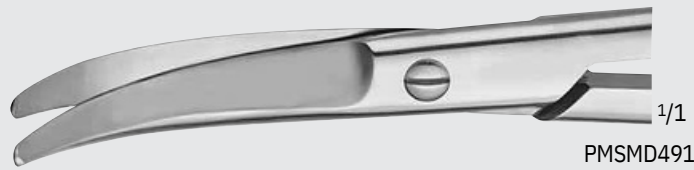

1/1

PMSMD491

**SIEBOLD Uterine Scissors**

Catalog Number	Tip	Blade	Length (in.)
PMSBC760R	B/B	CVD	9 5/8

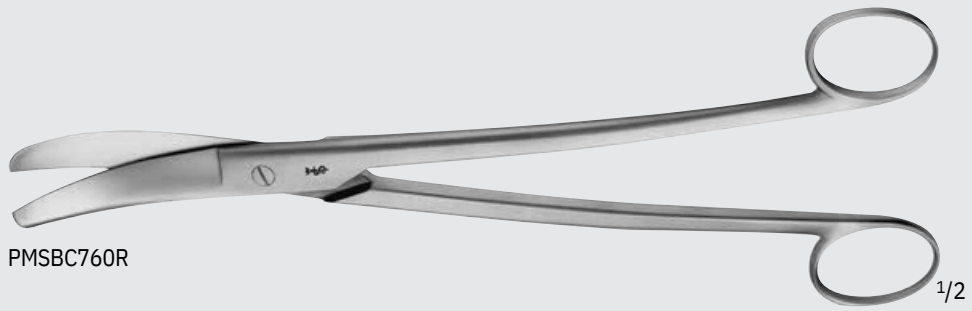

PMSBC760R

1/2



1/2



1/1

PMSBC760R



# Obstetrics/Gynecology

## Scissors

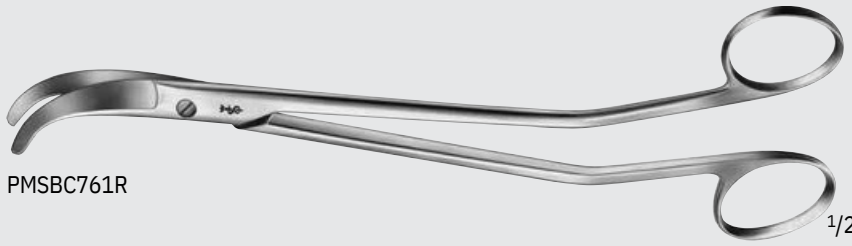

### BOZEMANN Uterine Scissors

Catalog Number	Tip	Blade	Length (in.)
PMSBC761R	B/B	CVD	8 3/4



### SIMS-SIEBOLD Uterine Scissors

Catalog Number	Tip	Blade	Length (in.)
PMSBC762R	B/B	STR	9 3/4

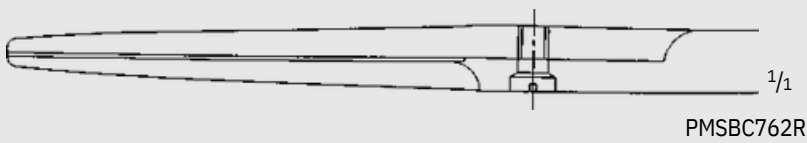
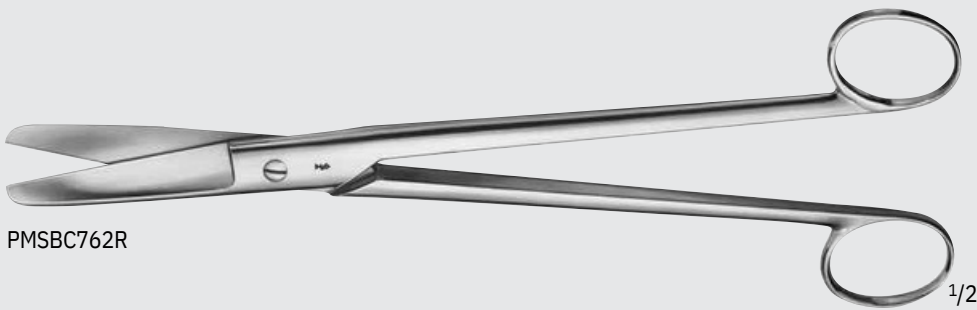

OB/GYN



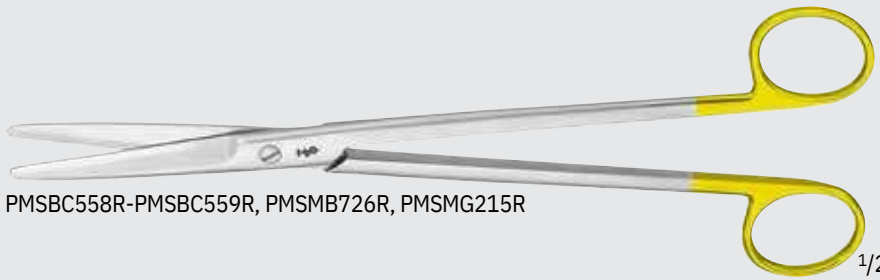

PMSBC558R-PMSBC559R, PMSMB726R, PMSMG215R

**DUROTIP TC MAYO Dissecting Scissors**

Catalog Number	Tip	Blade	Length (in.)
PMSBC558R	B/B	STR	9
PMSMG215R	B/B	STR	14
PMSBC559R	B/B	CVD	9
PMSMB726R	B/B	CVD	14

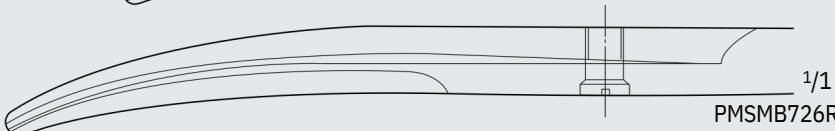
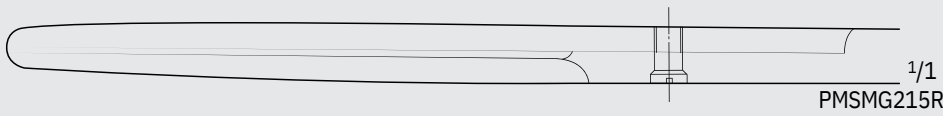
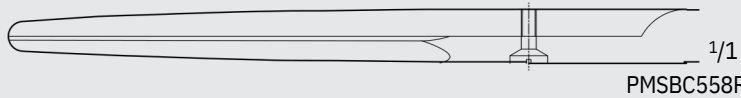

PMSBC290R-PMSBC291R

**DUROTIP TC SIMS Uterine Scissors**

Catalog Number	Tip	Blade	Length (in.)
PMSBC290R	B/B	CVD	7 7/8
PMSBC291R	B/B	CVD	9

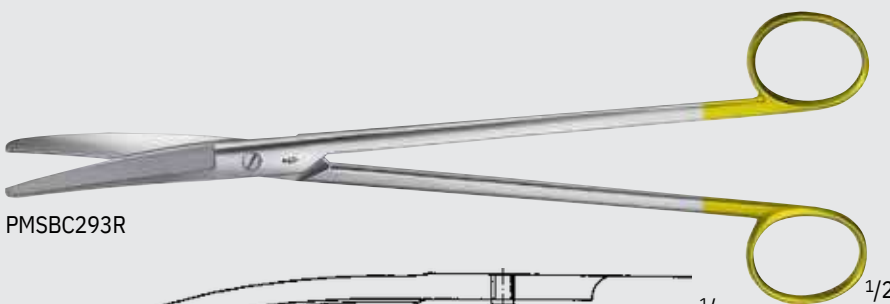

PMSBC293R

**DUROTIP TC WERTHEIM Scissors**

Catalog Number	Length (in.)
PMSBC293R	9

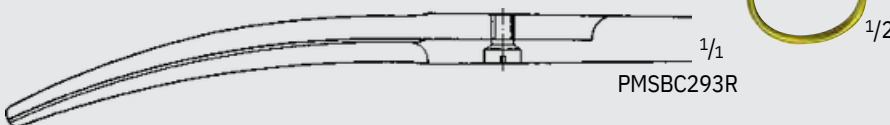

INCHES

# Obstetrics/Gynecology

## DUROTIP™ TC Scissors

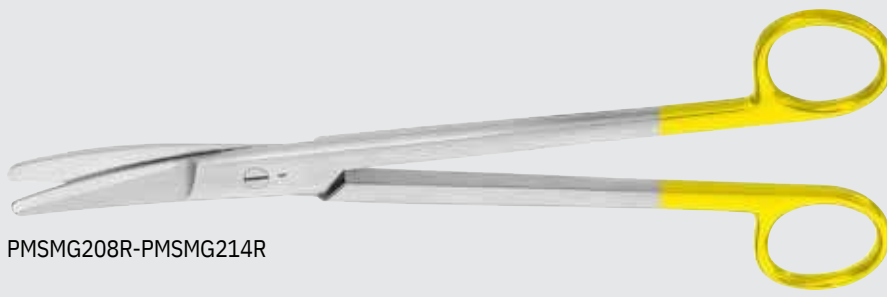

PMSMG208R-PMSMG214R

### DUROTIP TC Uterine Scissors

Catalog Number	Tip	Length (in.)
PMSMG208R	SLIGHT CVD	9
PMSMG209R	STRONG	9
PMSMG210R	CVD ANG	9
PMSMG211R	ANG SLIGHT	10 1/2
PMSMG212R	CVD	11 3/4
PMSMG213R	STRONG	11 3/4
PMSMG214R	CVD ANG	11 3/4

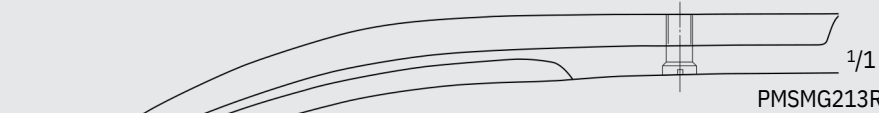
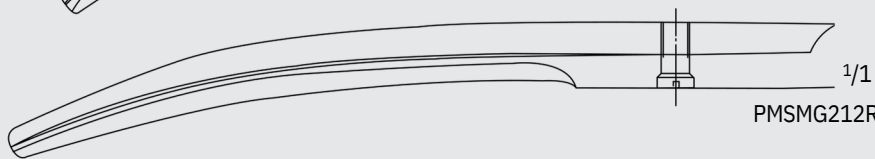
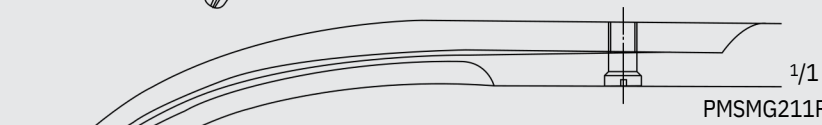
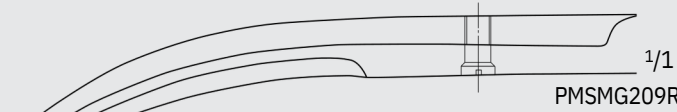
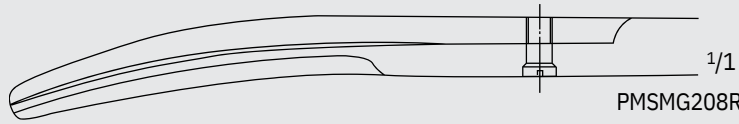

OB/GYN

MILLIMETERS



**Wavecut** Wavecut scissors have one serrated cutting edge to help prevent tissue from slipping. The W after the item number indicates the scissors are the wavecut style, e.g. PMSBC211W.

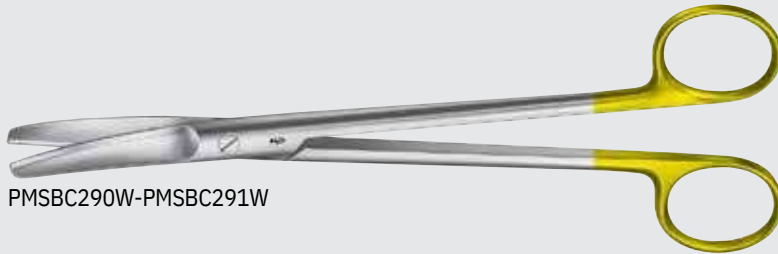

PMSBC290W-PMSBC291W

**DURROTIP TC SIMS Uterine Wavecut Scissors**

Catalog Number	Tip	Blade	Length (in.)
PMSBC290W	B/B	CVD	7 7/8
PMSBC291W	B/B	CVD	9

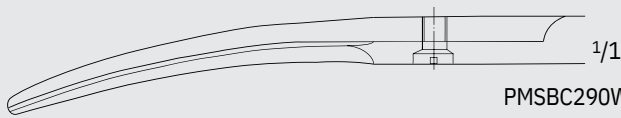

PMSBC290W



PMSBC291W

**DURROTIP TC METZENBAUM Wavecut Dissecting Scissors, Heavy**

Catalog Number	Tip	Blade	Length (in.)
PMSBC287W	B/B	CVD	9

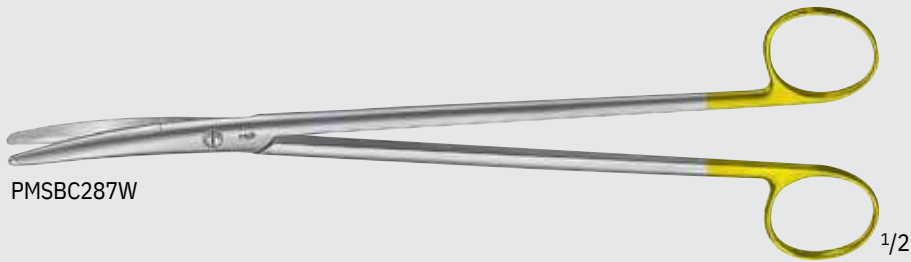

PMSBC287W

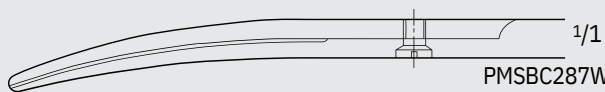

PMSBC287W



INCHES

OB/GYN

# Obstetrics/Gynecology

## Scissors



PMSBC796R-PMSBC797R

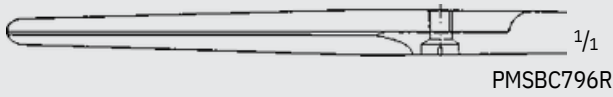

PMSBC796R <sup>1</sup>/<sub>1</sub>

### Umbilical Cord Scissors

Catalog Number	Tip	Blade	Length (in.)
PMSBC796R	B/B	LAT-CVD	5 1/4
PMSBC797R	B/B	LAT-CVD	6 1/4

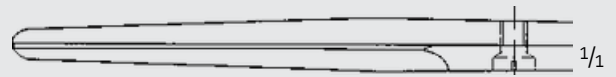

PMSBC797R <sup>1</sup>/<sub>1</sub>



PMSET152R <sup>1</sup>/<sub>2</sub>

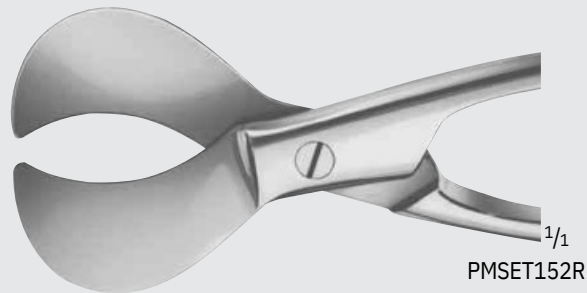

PMSET152R <sup>1</sup>/<sub>1</sub>

### Umbilical Cord Scissors

Catalog Number	Length (in.)
PMSET152R	4 1/8

OB/GYN

**SCHUHMACHER Umbilical Cord Scissors**

Catalog Number	Length (in.)
PMSET150R	6 1/8

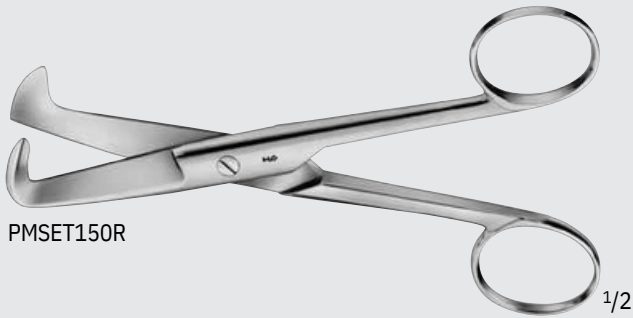

PMSET150R

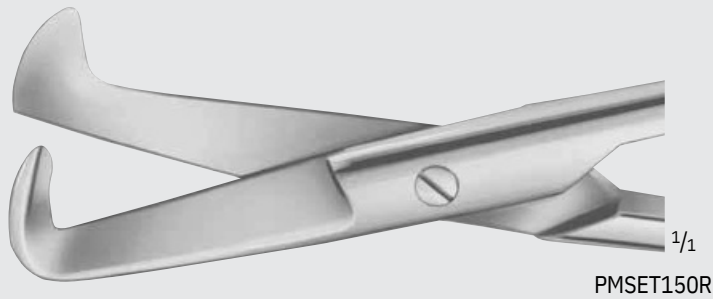

PMSET150R

**BRAUN-STADLER Episiotomy Scissors**

Catalog Number	Blade	Length (in.)
PMSET140R	SERR	5 3/4
PMSET141R	SERR	7 7/8



PMSET140R-PMSET141R

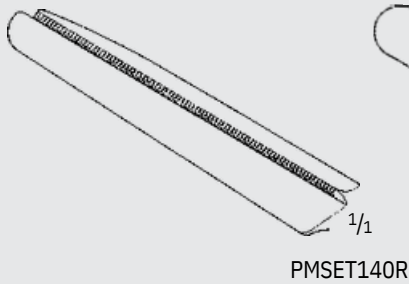

PMSET140R

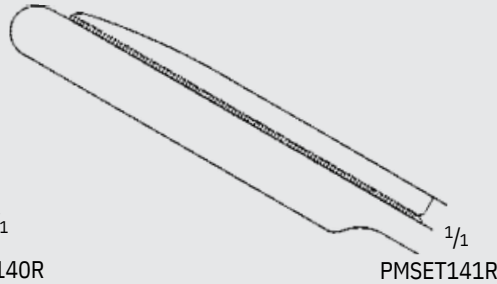

PMSET141R



# Obstetrics/Gynecology

## Needle Holders

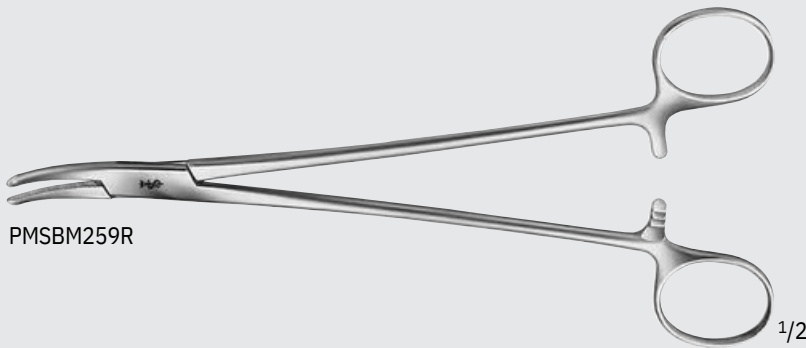

PMSBM259R



PMSBM259R

### HEANEY Needle Holder

Catalog Number	Tip	Jaw	Length (in.)
PMSBM259R	CVD	SERR	7 7/8

Aesculap features Needle Holders with Tungsten Carbide (TC) inserts. A smooth jaw and three different serration patterns are available, depending on the size of the suture needle.

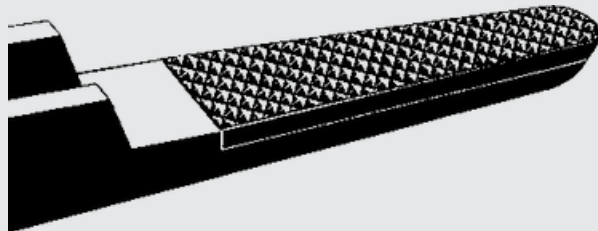
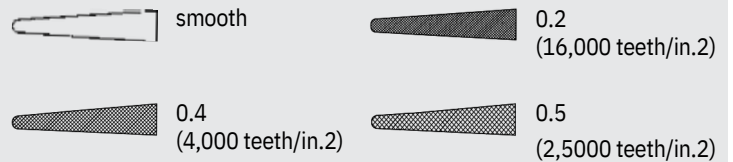

We recommend carbide inserts as follows:

#### Jaw Surface

- Smooth
- 0.2 mm pitch of serration
- 0.4 mm pitch of serration
- 0.5 mm pitch of serration

#### Suture Material

- 9/0 - 11/0
- 6/0 - 10/0
- 4/0 - 6/0
- up to 3/0

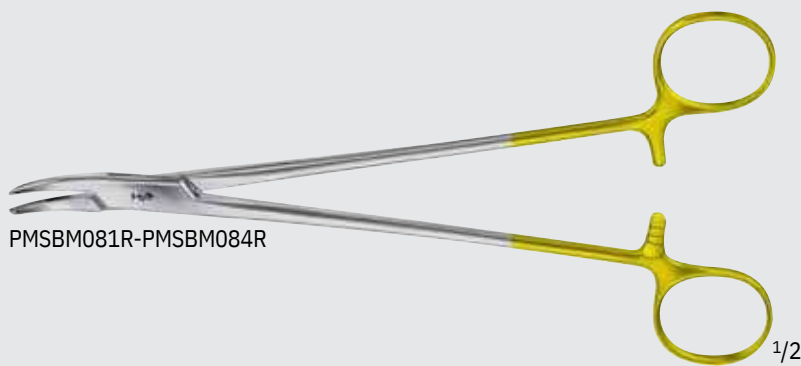

PMSBM081R-PMSBM084R

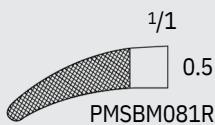

PMSBM081R

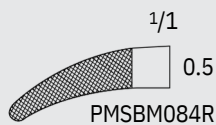

PMSBM084R

### DUROGRIP™ TC HEANEY Needle Holder

Catalog Number	Tip	Jaw	Length (in.)
PMSBM081R	CVD	SERR	7 7/8
PMSBM084R	CVD	SERR	10 1/4

OB/GYN

# Obstetrics/Gynecology

## Tenaculum and Sponge Forceps

### MAIER Forceps

Catalog Number	Jaw	Length (in.)
PMSBF056R	STR	10 1/2
PMSBF057R	CVD	10 1/2

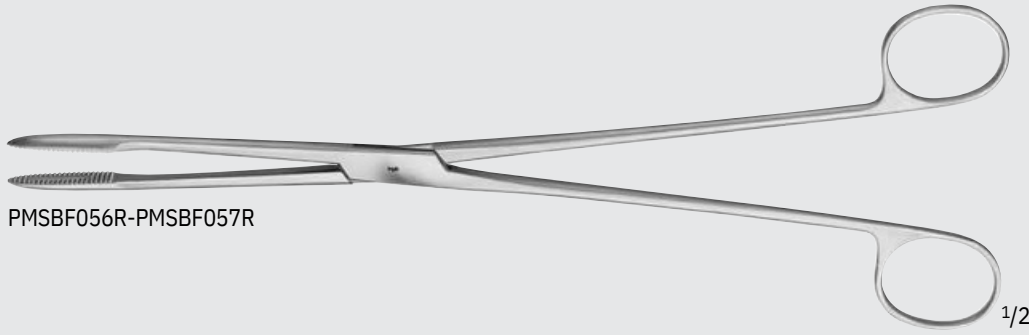

PMSBF056R-PMSBF057R



PMSBF056R

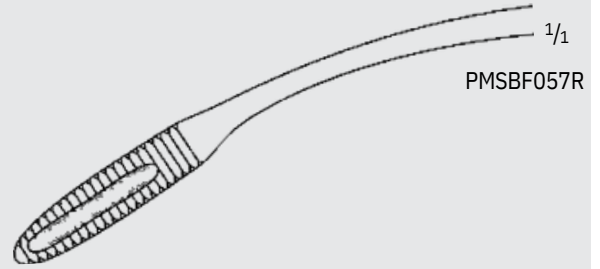

PMSBF057R

### MAIER Forceps, W/ Ratchet

Catalog Number	Jaw	Length (in.)
PMSBF058R	STR	10 1/4
PMSBF059R	CVD	10 1/4



PMSBF058R-PMSBF059R



PMSBF058R

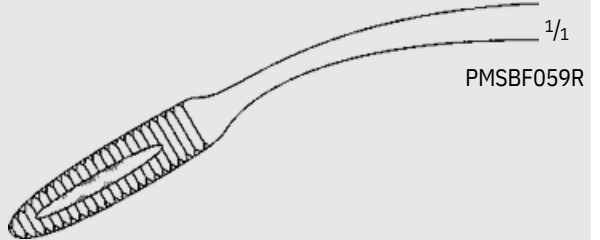

PMSBF059R



INCHES

# Obstetrics/Gynecology

## Tenaculum and Sponge Forceps

### SIMS-MAIER Sponge Forceps, W/ Ratchet

Catalog Number	Jaw	Length (in.)
PMSBF076R	STR	11
PMSBF077R	CVD	11

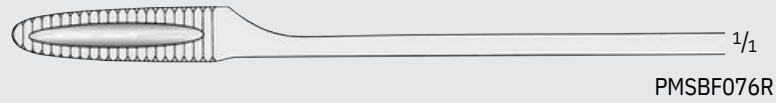

### PELKMANN Forceps

Catalog Number	Tip	Jaw	Length (in.)
PMSEO060R	SERR	STR	10 1/4
PMSEO061R	SERR	CVD	10 1/4

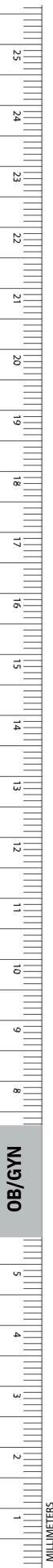
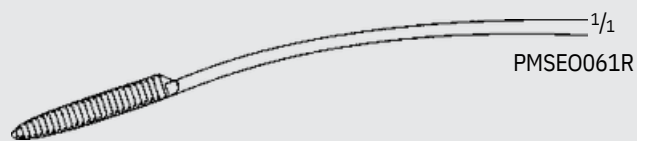
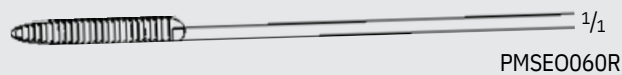
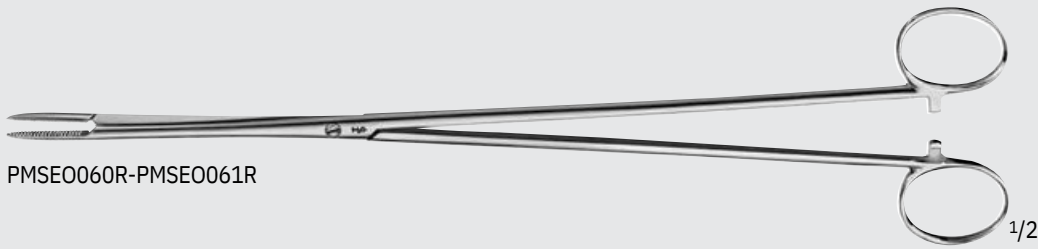

OB/GYN



**BOZEMANN Forceps**

Catalog Number	Shaft	Jaw	Length (in.)
PMSE0080R	STR	SERR	10 1/4
PMSE0075R	S-CVD	SMOOTH	9 3/4
PMSE0082R	S-CVD	SERR	9 3/4
PMSE0077R	S-CVD	W/ GROOVE	10

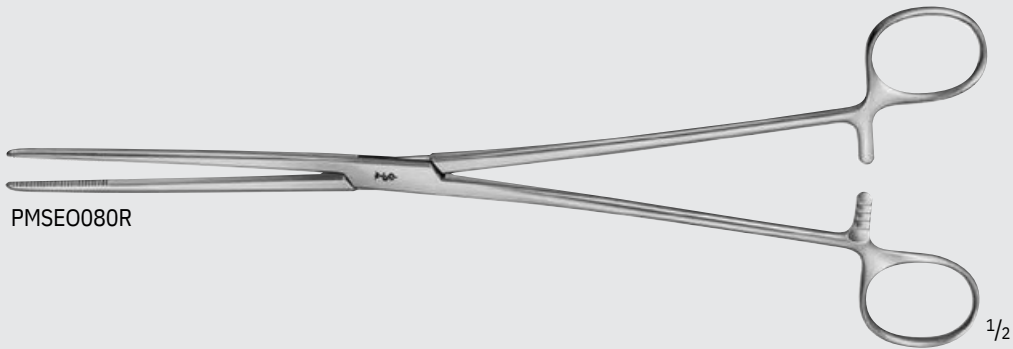

PMSE0080R



PMSE0080R

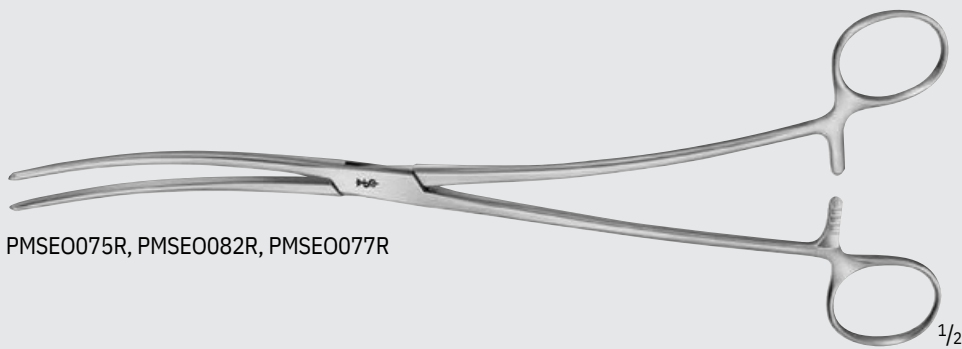

PMSE0075R, PMSE0082R, PMSE0077R



PMSE0075R, PMSE0082R, PMSE0077R



# Obstetrics/Gynecology

## Tenaculum and Sponge Forceps

### BOZEMANN-DOUGLAS Forceps

Catalog Number	Tip	Length (in.)
PMSEO085R	SERR	10 1/4

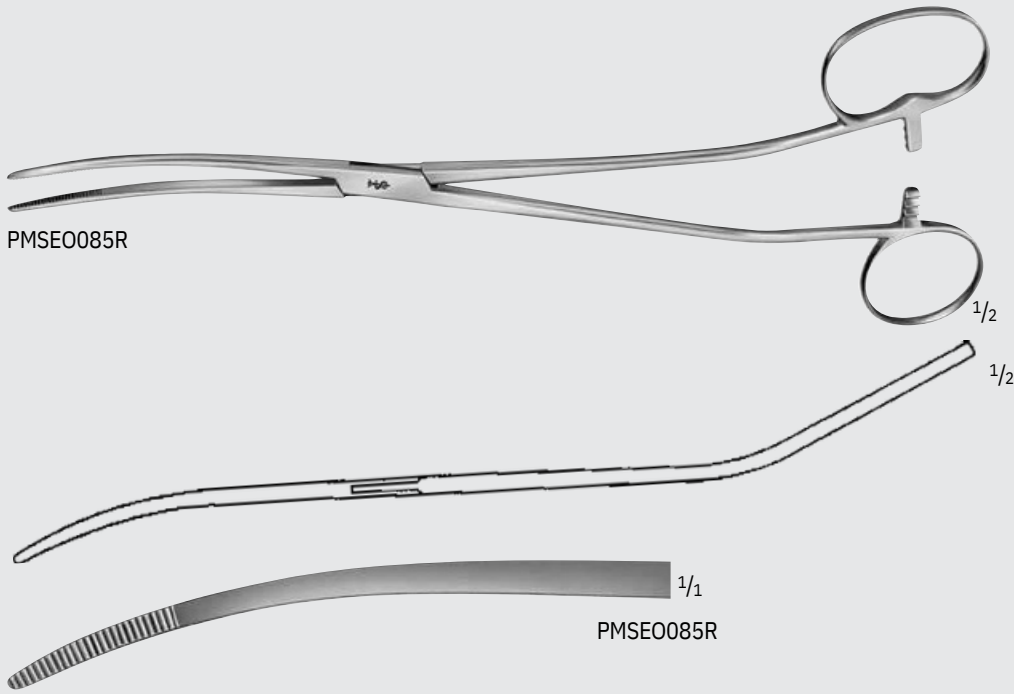

### ADAIR Uterine Forceps

Catalog Number	Teeth	Length (in.)
PMSEO106R	1 x 1	7 1/2

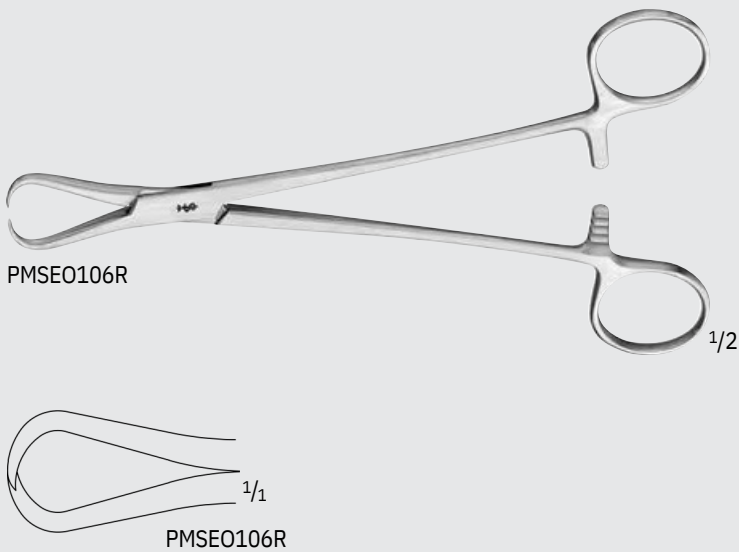

OB/GYN

**Obstetrics/Gynecology**  
 Tenaculum and Sponge Forceps

**POZZI Tenaculum Forceps, Standard**

Catalog Number	Teeth	Length (in.)
PMSEO105R	1 x 1	6 7/8

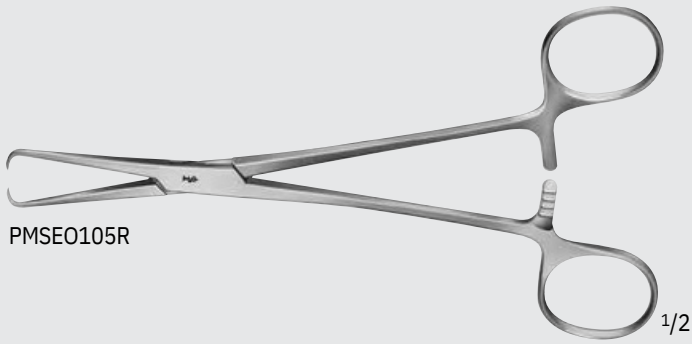

PMSEO105R

1/2

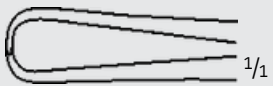

PMSEO105R

1/1

**BARRETT Uterine Tenaculum Forceps**

Catalog Number	Teeth	Length (in.)
PMSMG200R	1 x 1	7

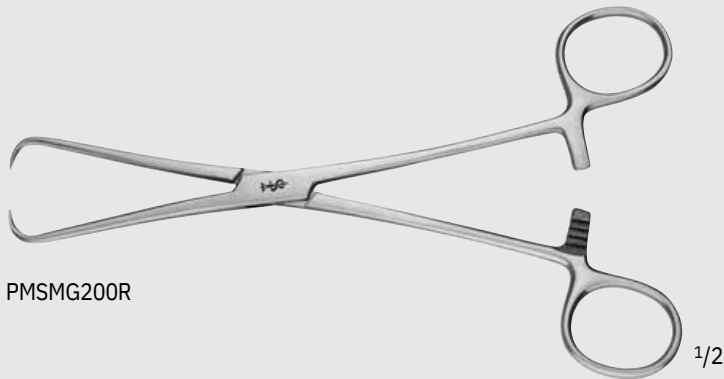

PMSMG200R

1/2



PMSMG200R

1/1



OB/GYN

INCHES

# Obstetrics/Gynecology

## Tenaculum and Sponge Forceps

### BRAUN Tenaculum Forceps

Catalog Number	Teeth	Length (in.)
EO108R	1 x 1	9 3/4

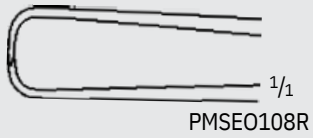
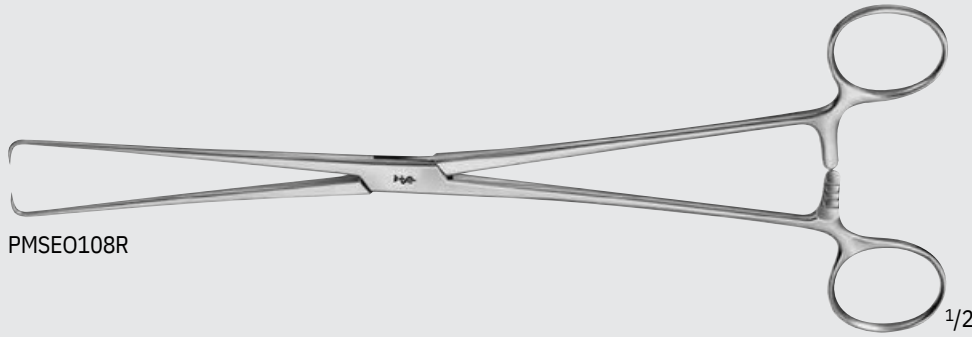

### SCHROEDER Tenaculum Forceps

Catalog Number	Shaft	Teeth	Length (in.)
PMSE0110R	STR	1 x 1	9 3/4

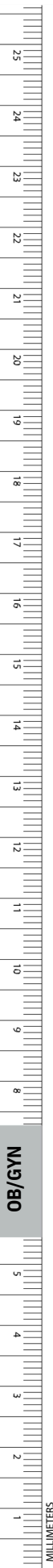
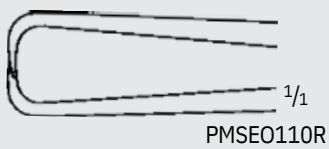
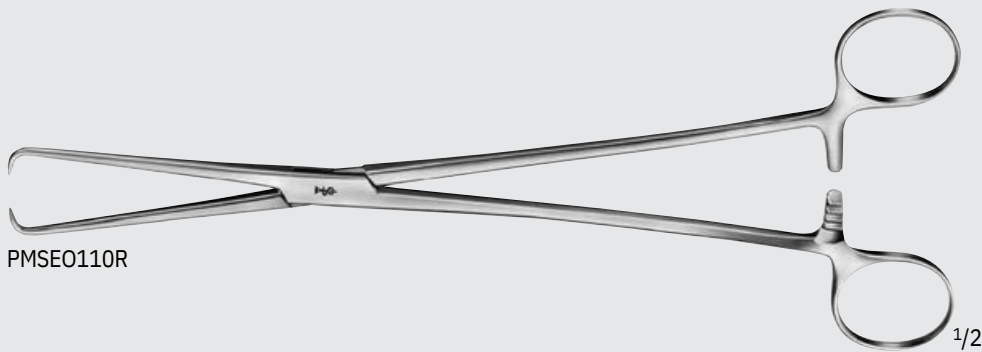

OB/GYN

**SCHROEDER Tenaculum Forceps**

Catalog Number	Shaft	Teeth	Length (in.)
PMSE0150R	STR	2 x 2	9 3/4
PMSE0151R	CVD	2 x 2	9 3/4
PMSE0163R	STR	3 x 3	10 5/8

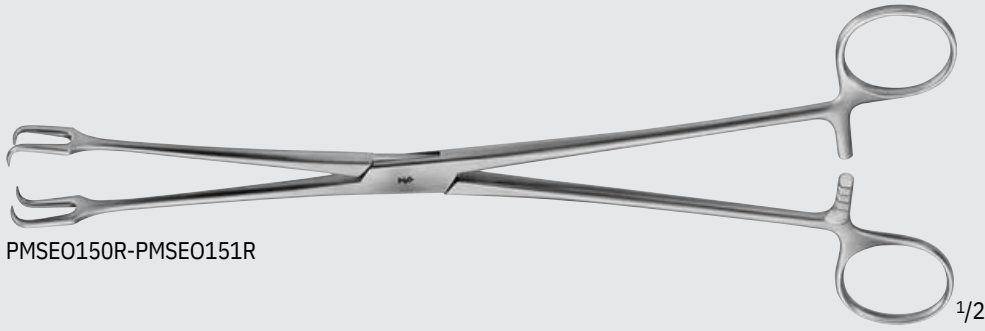

PMSE0150R-PMSE0151R



PMSE0150R



PMSE0151R

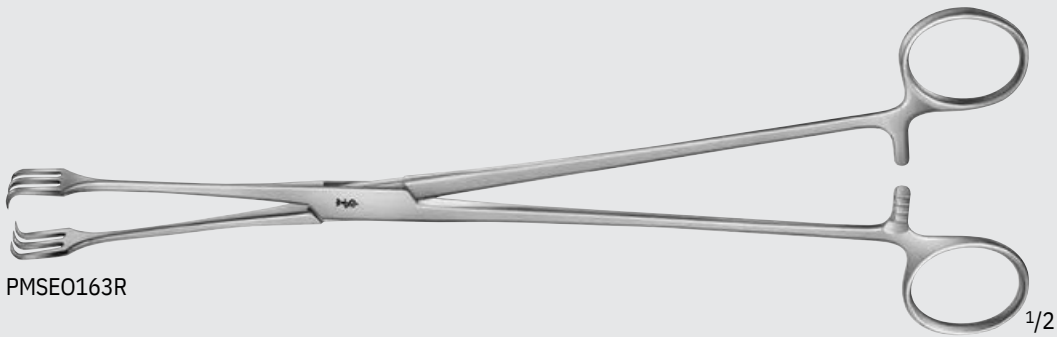

PMSE0163R

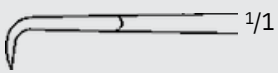

PMSE0163R

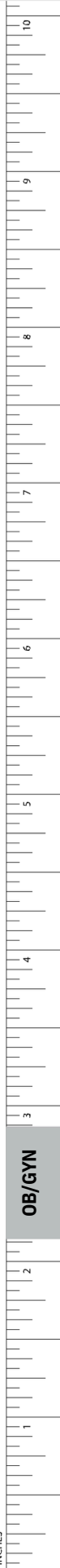

# Obstetrics/Gynecology

## Tenaculum and Sponge Forceps

### POZZI Tenaculum Forceps, Heavy

Catalog Number	Teeth	Length (in.)
PMSE0125R	1 x 1	10



PMSE0125R

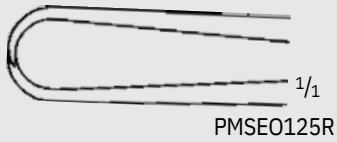

PMSE0125R

### DUPLAY Tenaculum Forceps, Delicate

Catalog Number	Teeth	Length (in.)
PMSE0130R	1 x 1	9 3/4

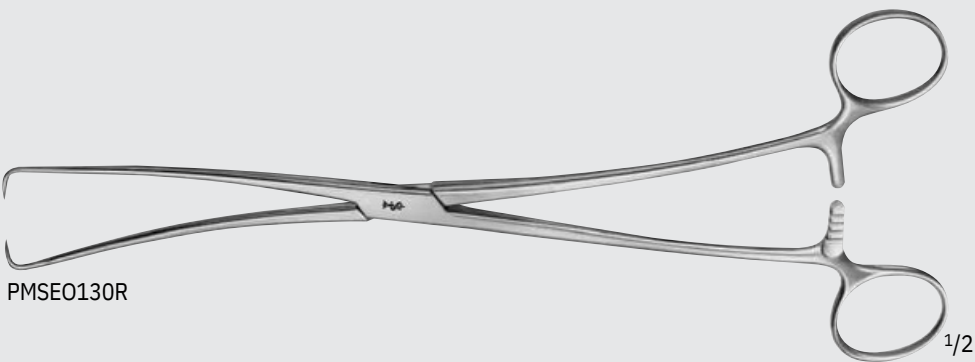

PMSE0130R

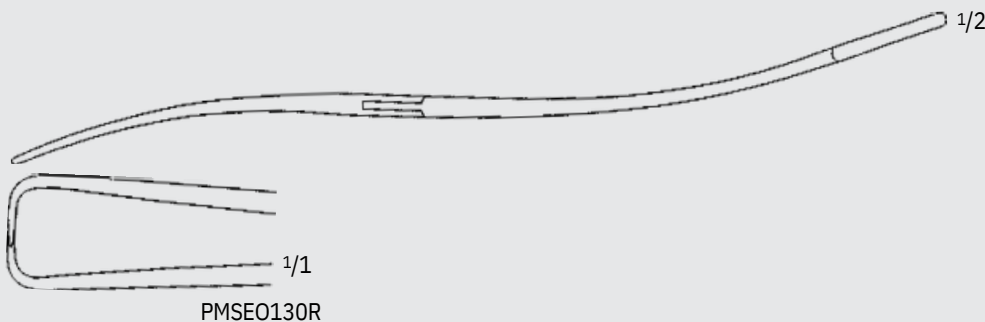

PMSE0130R

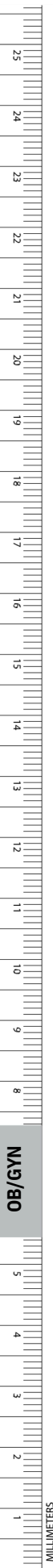

**ABEL Tenaculum Forceps**

Catalog Number	Teeth	Length (in.)
PMSE0140R	1 x 1	11

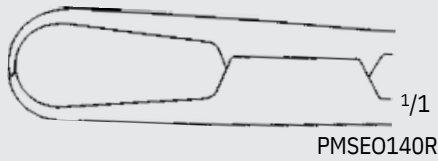

**HENROTIN Uterine Vulsellum Forceps**

Catalog Number	Teeth	Length (in.)
PMSG202R	2 x 3	8 1/4

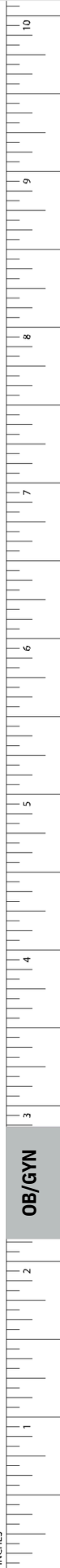
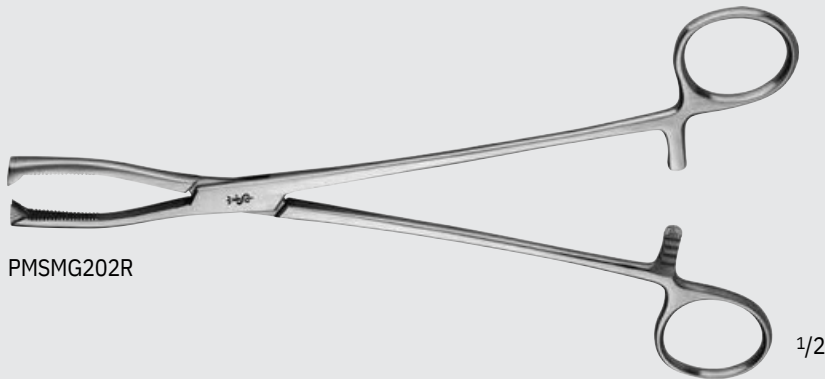

INCHES

OB/GYN

# Obstetrics/Gynecology

## Tenaculum and Sponge Forceps

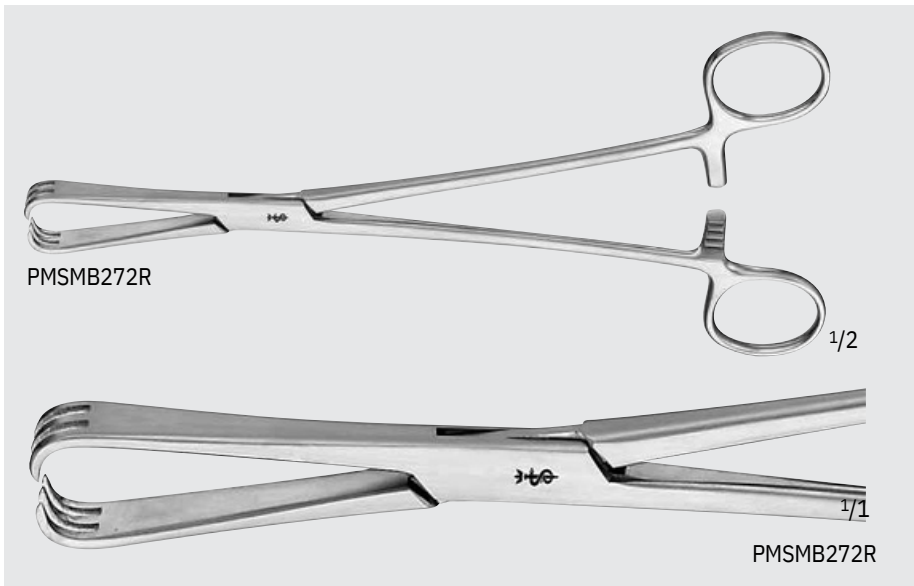

### GORDON Uterine Vulsellum Forceps

Catalog Number	Teeth	Length (in.)
PMSMB272R	3 x 3	8 3/4

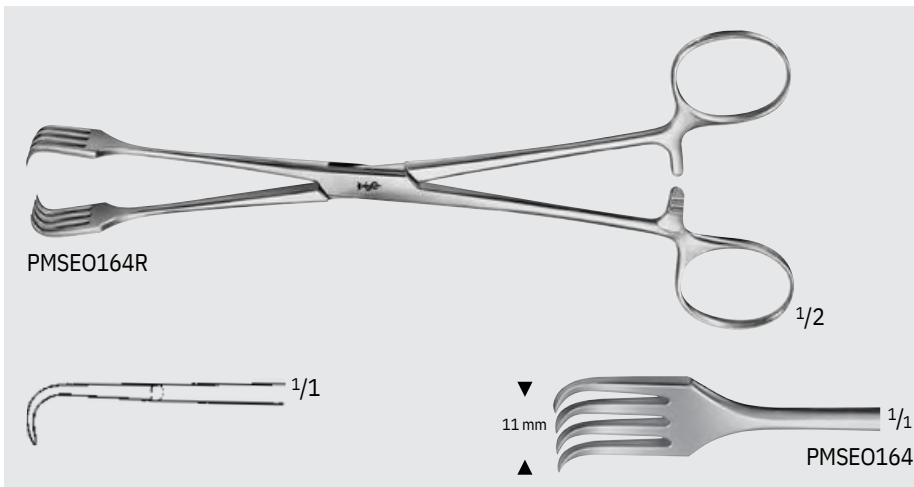

### CZERNY Uterine Tenaculum Forceps

Catalog Number	Teeth	Length (in.)
PMSEO164R	4 x 4	7 7/8

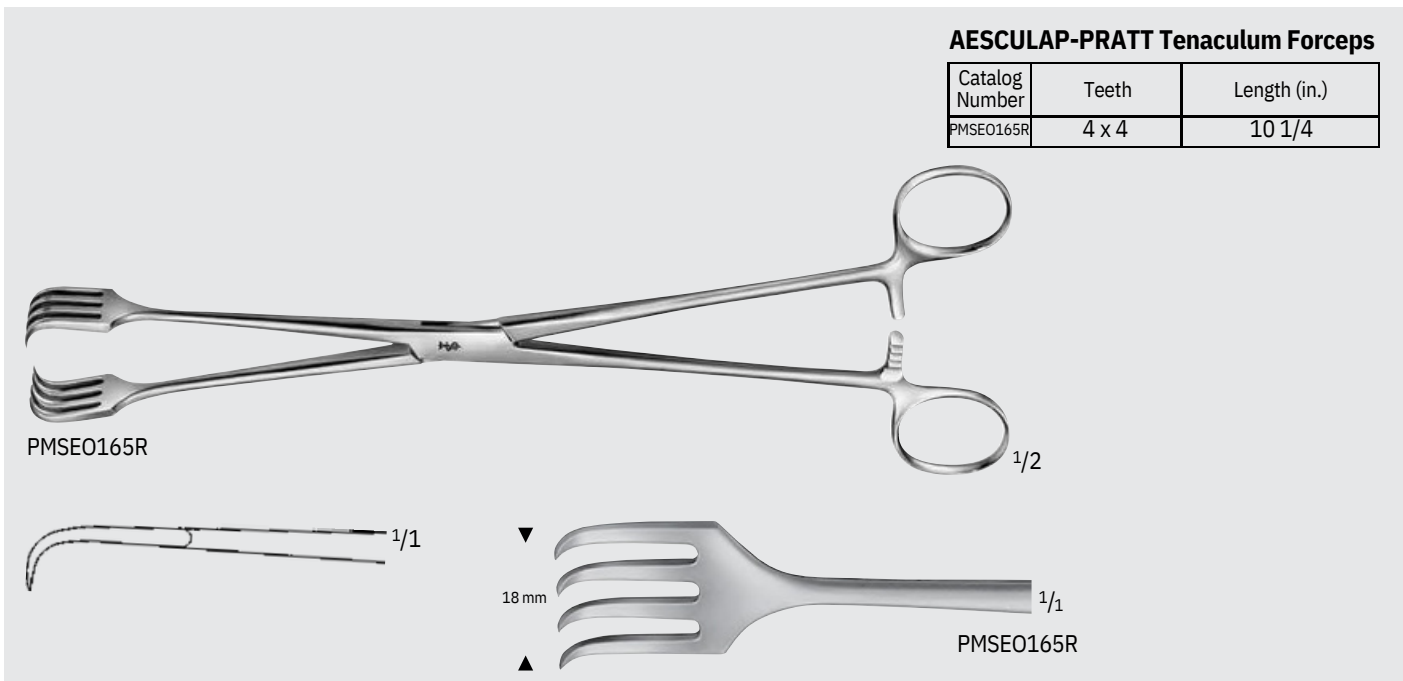

### AESCULAP-PRATT Tenaculum Forceps

Catalog Number	Teeth	Length (in.)
PMSEO165R	4 x 4	10 1/4



# Obstetrics/Gynecology

## Tenaculum and Sponge Forceps

### PRATT Tenaculum Forceps

Catalog Number	Teeth	Length (in.)
PMSE0166R	4 x 4	10 5/8



PMSE0166R

1/2

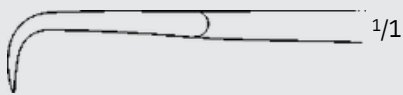

1/1



22 mm

1/1

PMSE0166R

### TEALE Tenaculum Forceps

Catalog Number	Teeth	Length (in.)
PMSG184R	3 x 4	9 5/8
PMSE0180R	3 x 4	10

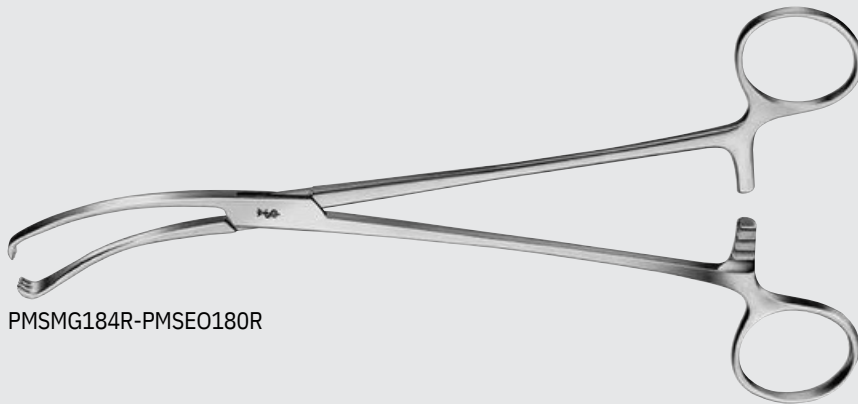

PMSG184R-PMSE0180R

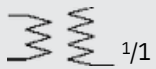

1/1

PMSG184R-PMSE0180R



INCHES

OB/GYN

# Obstetrics/Gynecology

## Tenaculum and Sponge Forceps

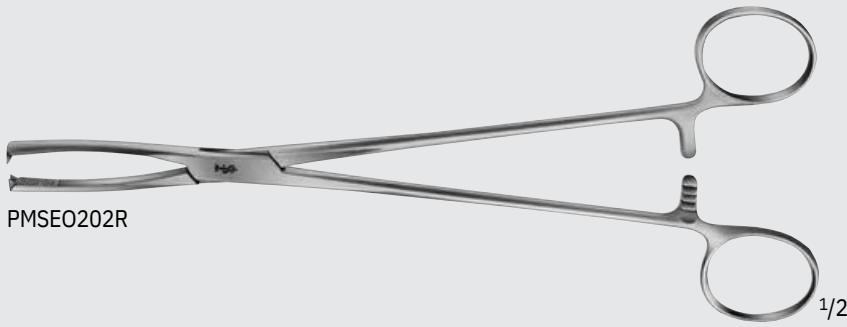

PMSEO202R

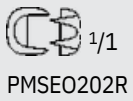

### JACOBS Vulsellum Forceps

Catalog Number	Teeth	Length (in.)
PMSEO202R	2 x 2	8 1/2

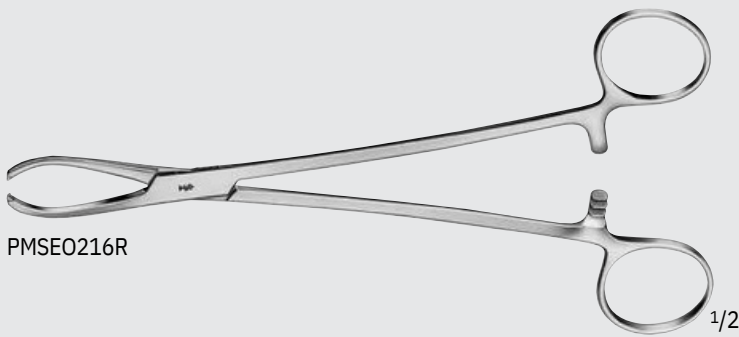

PMSEO216R

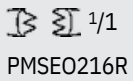

### LITTLEWOOD Tenaculum Forceps

Catalog Number	Teeth	Length (in.)
PMSEO216R	2 x 3	7 1/4

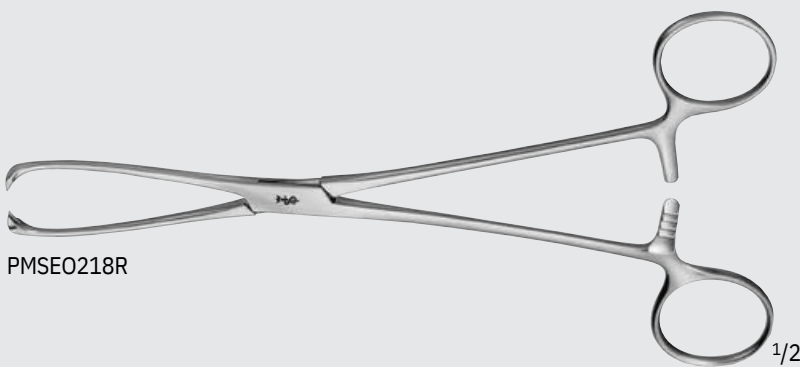

PMSEO218R

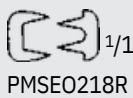

### MUSEUX Tenaculum Forceps, Small

Catalog Number	Teeth	Length (in.)
PMSEO218R	2 x 2	7 7/8

OB/GYN

**MUSEUX Tenaculum Forceps**

Catalog Number	Jaw	Length (in.)
PMSE0220R	STR	9 1/2
PMSE0221R	STR	9 1/2
PMSE0222R	STR	9 1/2

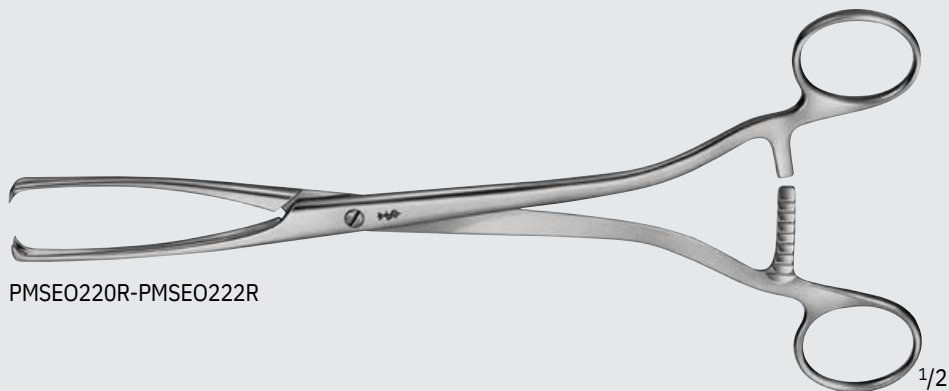

PMSE0220R-PMSE0222R

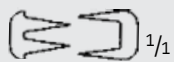

PMSE0220R

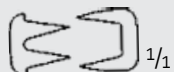

PMSE0221R

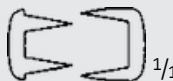

PMSE0222R

**MUSEUX Tenaculum Forceps**

Catalog Number	Jaw	Length (in.)
PMSE0225R	CVD	9 1/2

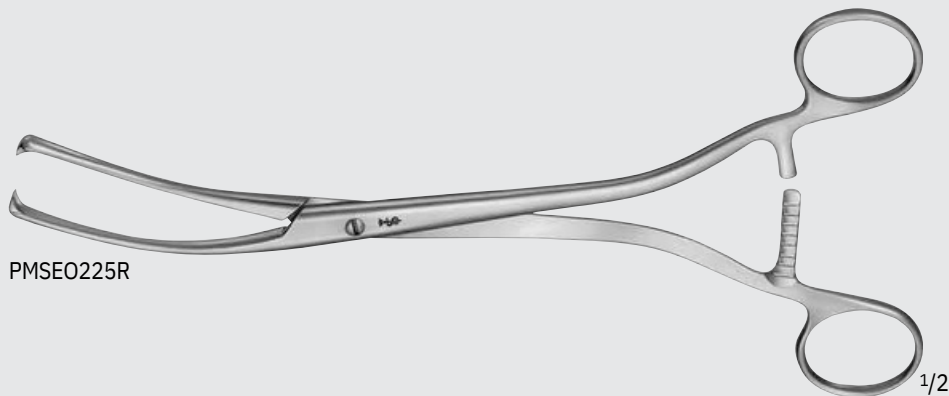

PMSE0225R

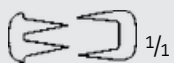

PMSE0225R



# Obstetrics/Gynecology

## Tenaculum and Sponge Forceps

### MUSEUX Tenaculum Forceps

Catalog Number	Jaw	Size	Length (in.)
PMSEO240R	STR	LARGE	10 1/2
PMSEO242R	STR	X-LARGE	10 1/2

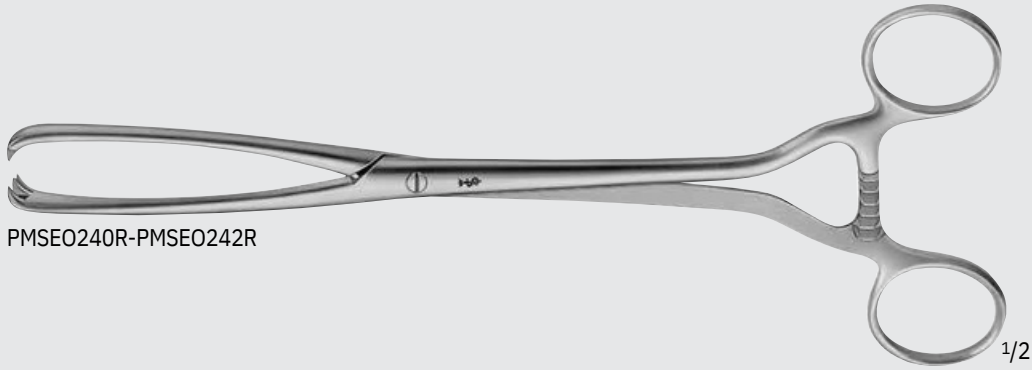

PMSEO240R-PMSEO242R

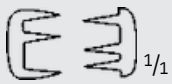

PMSEO240R



PMSEO242R

### FLETCHER-VAN DOREN Uterine Polyp, Sponge Holding Forceps

Catalog Number	Length (in.)
PMSMB273R	9 1/2

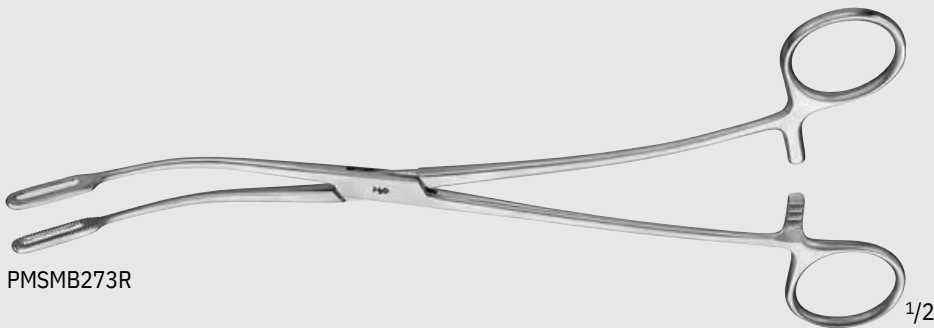

PMSMB273R



PMSMB273R

OB/GYN

MILLIMETERS

**FLETCHER Sponge Forceps**

Catalog Number	Tip	Length (in.)
PMSG193R	STR	9 3/4

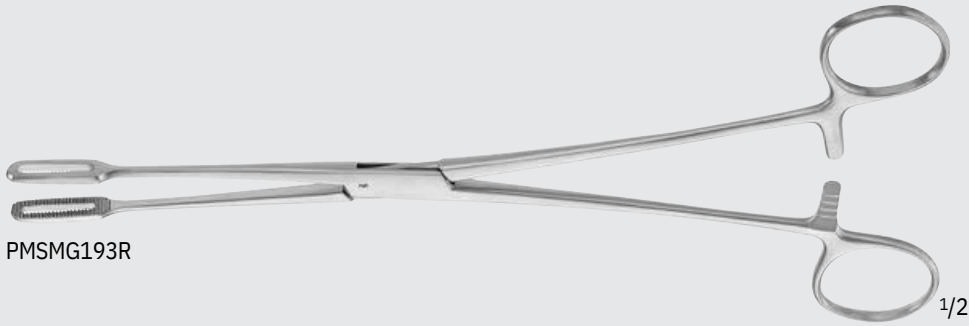

**OVERSTREET Endometrial Polyp Forceps**

Catalog Number	Jaw	Length (in.)
PMSG195R	HOLLOW, FENESTRATED	9 1/4

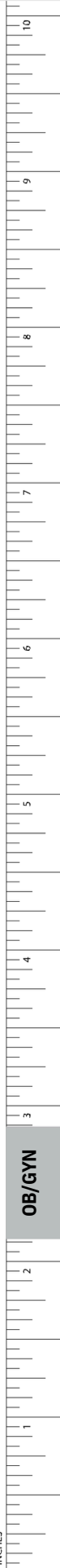
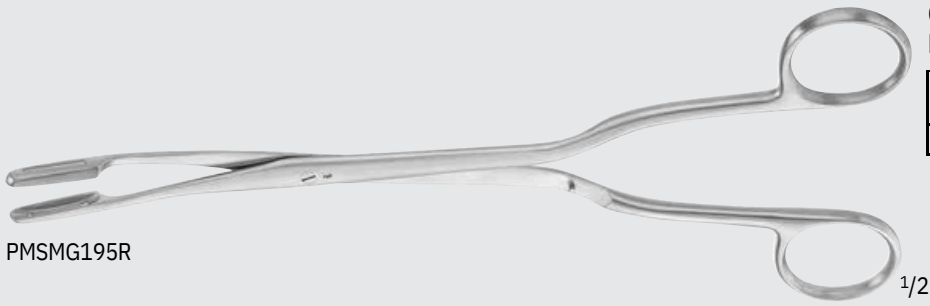

# Obstetrics/Gynecology

## Polyp Forceps

### HEYWOOD-SMITH Polyp Forceps

Catalog Number	Length (in.)
PMSE0310R	9 3/4

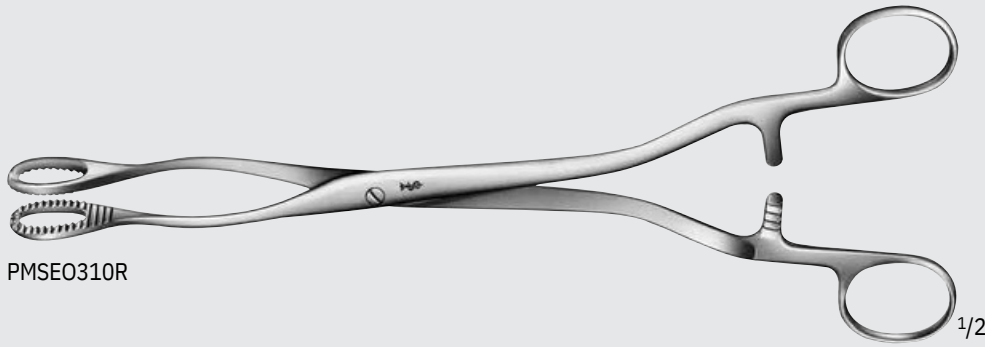

PMSE0310R

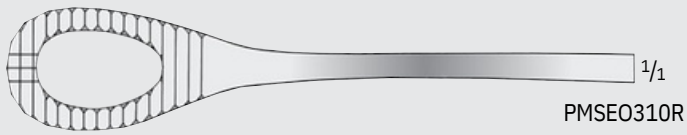

PMSE0310R

### NOTO Polyp Forceps

Catalog Number	Length (in.)
PMSE0315R	11

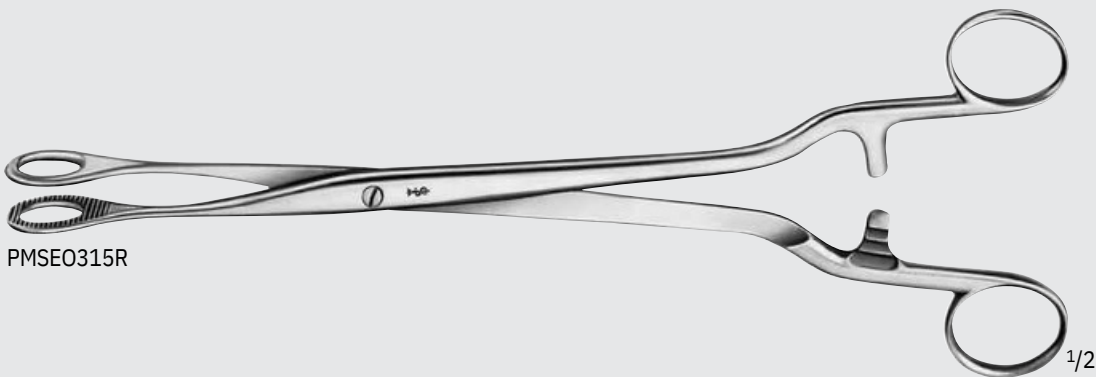

PMSE0315R



PMSE0315R

OB/GYN

**DOYEN Ovum Forceps**

Catalog Number	Length (in.)
PMSE0332R	7 1/4

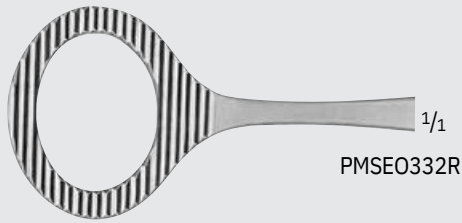
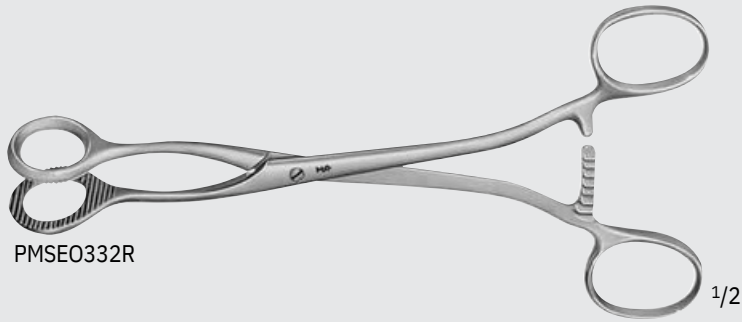

**Atraumatic Ovum Forceps**

Catalog Number	Tip	Length (in.)
PMSE0338R	SMALL	9 3/4

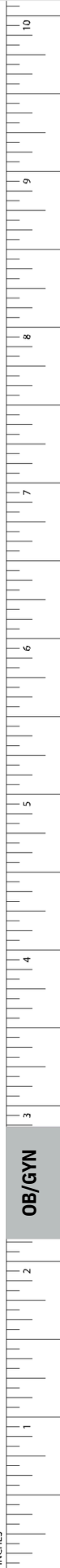
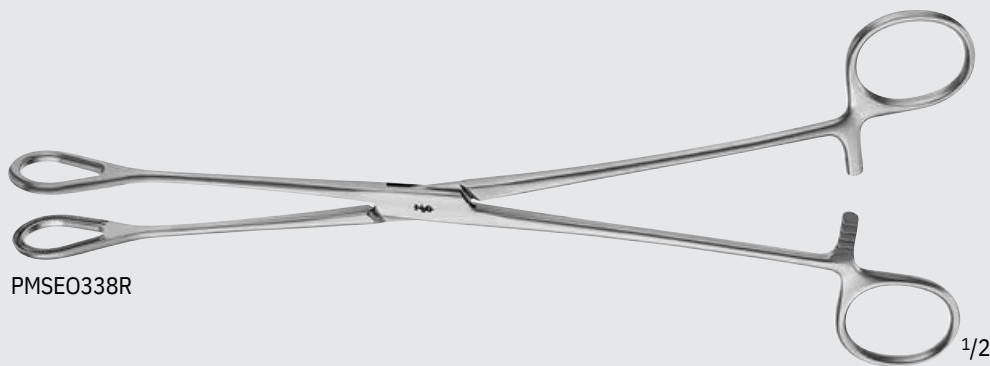

# Obstetrics/Gynecology

## Uterine Elevating Forceps



### DARTIGUES Elevating Forceps

Catalog Number	Length (in.)
PMSEO407R	10

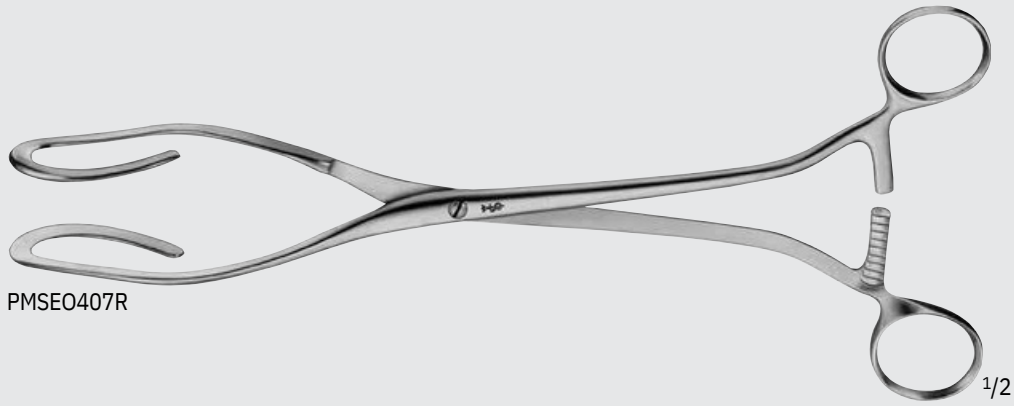

PMSEO407R

### SOMER Uterine Elevating Forceps

Catalog Number	Length (in.)
PMSEO415R	9 1/4



PMSEO415R



**COLLIN Uterine Elevating Forceps**

Catalog Number	Length (in.)
PMSE0405R	11 1/4



PMSE0405R

**COLLIN Uterine Elevating Forceps, Movable Jaw**

Catalog Number	Blade	Length (in.)
PMSE0420R	STR	10 1/2

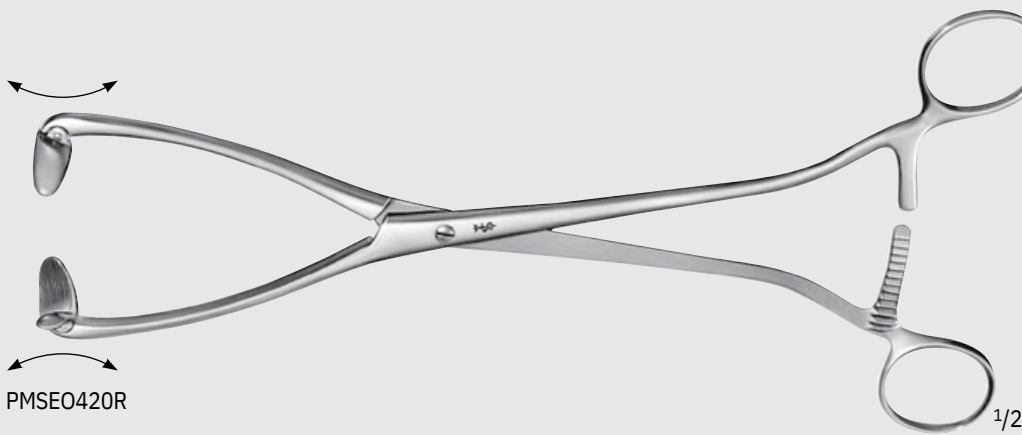

PMSE0420R

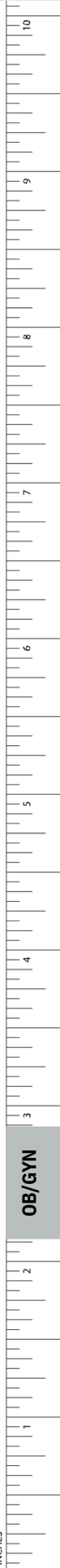

INCHES

OB/GYN

# Obstetrics/Gynecology

## Uterine Elevating and Membrane Forceps

### HULKA-KENWICK Uterine Elevating Forceps

Catalog Number	Length (in.)
PMSEO422R	10 3/4

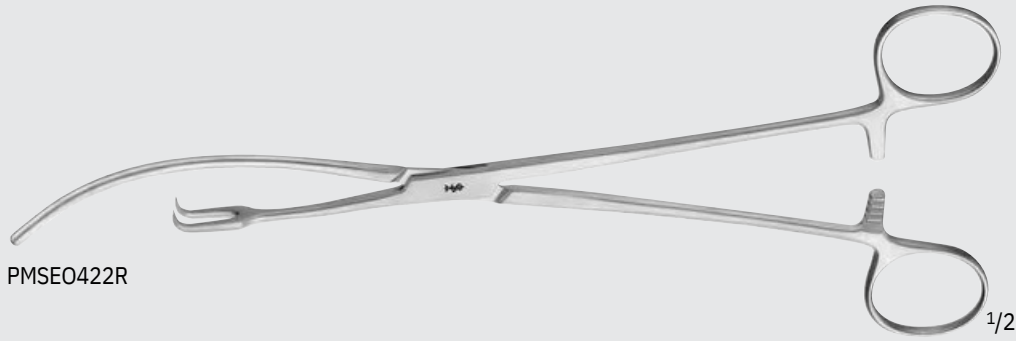

### IOWA Membrane Puncturing Forceps

Catalog Number	Length (in.)
PMSG189R	10

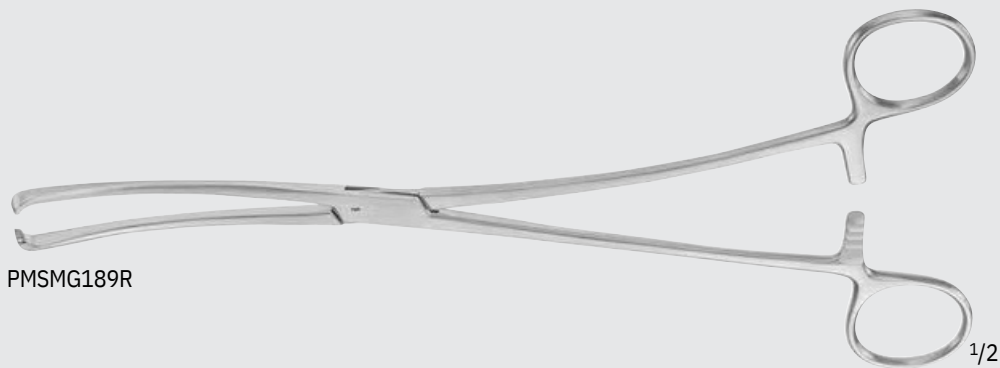

OB/GYN

MILLIMETERS

**DOYEN Myoma Screw**

Catalog Number	Length (in.)
PMSE0433R	6
PMSE0435R	7 1/2

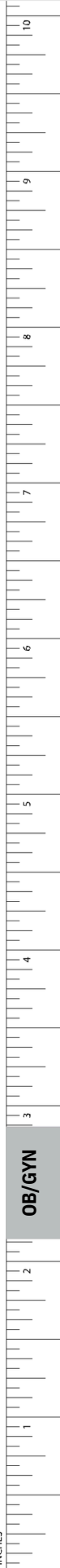
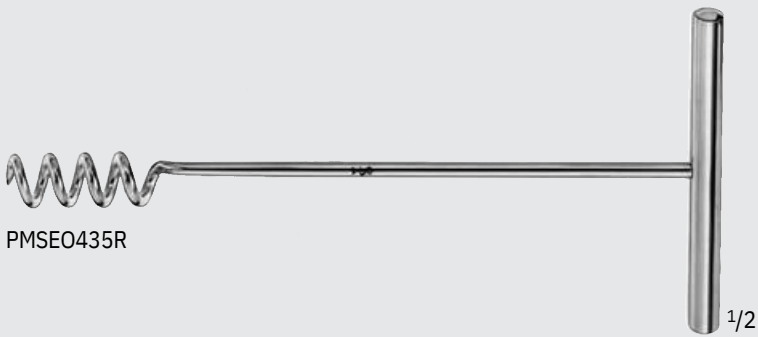

# Obstetrics/Gynecology

## Obstetrical Forceps



### NAEGELE Obstetrical Forceps

Catalog Number	Length (in.)
PMSET205R	14

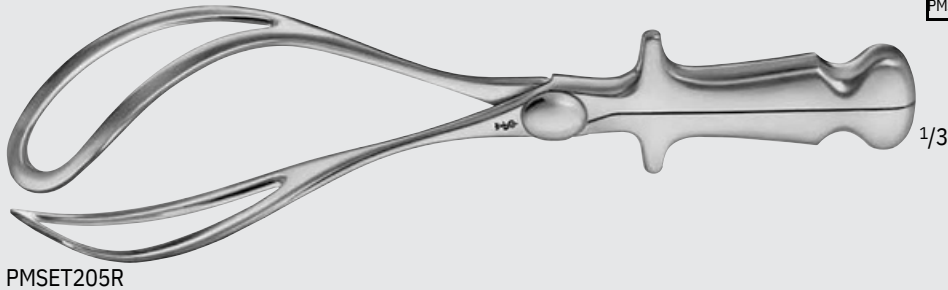

PMSET205R

### KIELLAND Obstetrical Forceps

Catalog Number	Length (in.)
PMSET210R	16 1/2

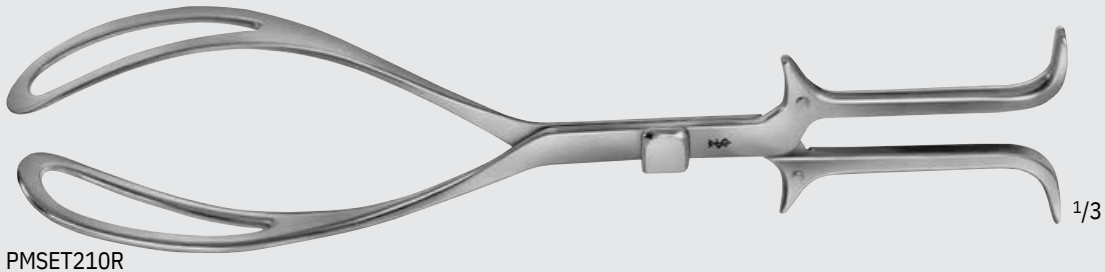

PMSET210R

### SIMPSON-BRAUN Obstetrical Forceps

Catalog Number	Length (in.)
PMSET220R	12
PMSET221R	13 3/4



PMSET220R



PMSET221R



**DE LEE Obstetrical Forceps**

Catalog Number	Length (in.)
PMSMG190R	12
PMSMG185R	14

PMSMG190R-PMSMG185R



**ELLIOTT Obstetrical Forceps**

Catalog Number	Length (in.)
PMSMG191R	15

PMSMG191R



**PIPER Obstetrical Forceps, F/ Breach**

Catalog Number	Length (in.)
PMSET237R	17 1/2

PMSET237R



# Obstetrics/Gynecology

## Obstetrical Forceps



PMSET245R

### SIMPSON C-Section Forceps

Catalog Number	Length (in.)
PMSET245R	9 1/4

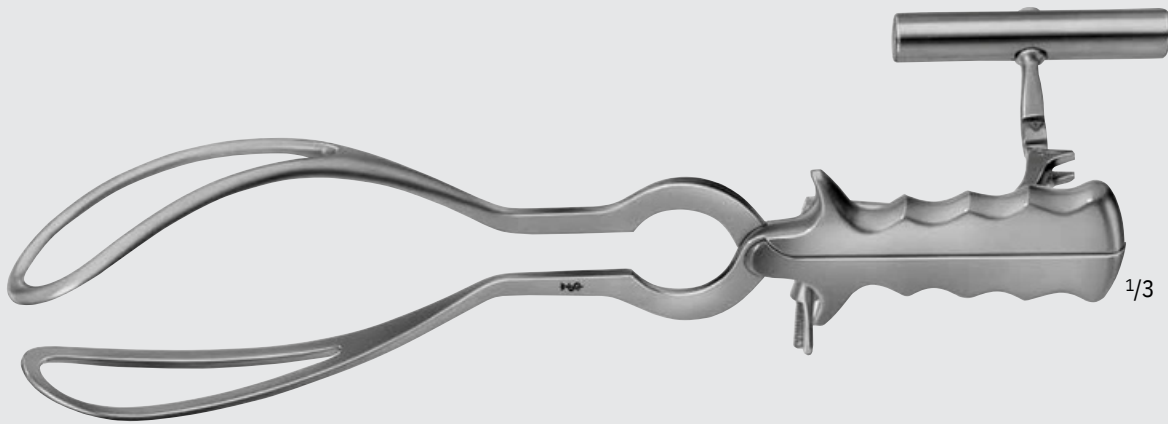

PMSET255R

### BARNES-NEVILLE Obstetrical Forceps, With Traction Handle

Catalog Number	Length (in.)
PMSET255R	17 1/8

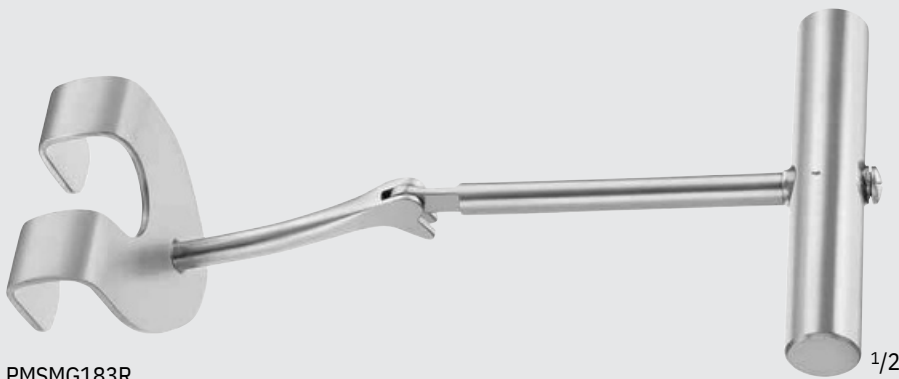

PMSG183R

### BILL Traction Handle

Catalog Number	Description
PMSG183R	FOR USE W/ STANDARD OB FORCEPS

OB/GYN

**LUIKART-SIMPSON Obstetrical Forceps**

Catalog Number	Length (in.)
PMSMB298R	14

1/3

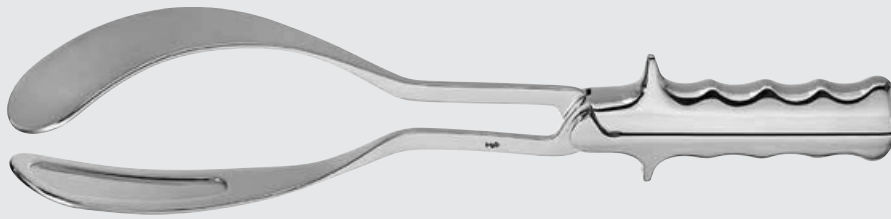

PMSMB298R

**LUIKART-MCLANE Obstetrical Forceps**

Catalog Number	Length (in.)
PMSMB299R	15 1/2

1/3



PMSMB299R

**LUIKART-KIELLAND Obstetrical Forceps**

Catalog Number	Length (in.)
PMSMB069R	15 1/2

1/3



PMSMB069R



INCHES

OB/GYN

# Obstetrics/Gynecology

## Obstetrical Forceps and Head Extractor

### LUIKHART Obstetrical Forceps

Catalog Number	Length (in.)
PMSMG186R	16



PMSMG186R

### MCLANE-TUCKER Obstetrical Forceps

Catalog Number	Length (in.)
PMSMG192R	16 1/4



PMSMG192R

### MURLESS Head Extractor

Catalog Number	Length (in.)
PMSMG492R	10



PMSMG492R

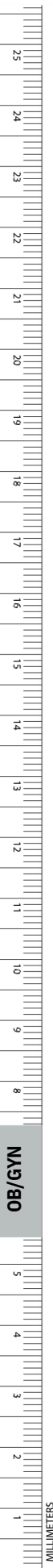



**SELLHEIM Obstetric Lever**

Catalog Number	Blade	Length (in.)
PMSET270R	OPEN	11 3/4



PMSET270R

11 3/4

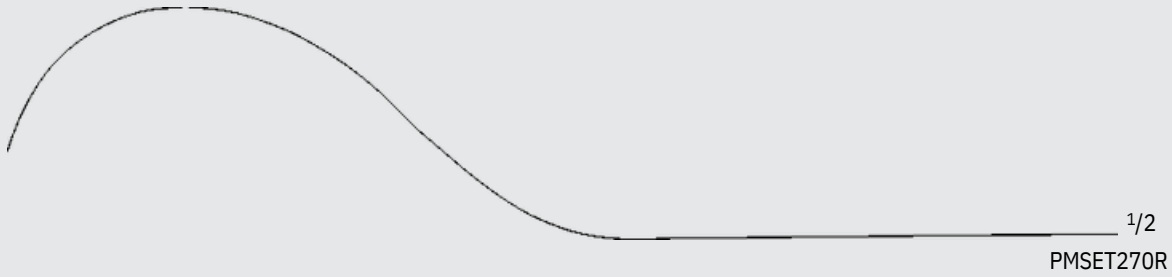

PMSET270R

11 3/4

**GREEN-ARMYTAGE Forceps, F/ C-Section**

Catalog Number	Length (in.)
PMSET269R	8 3/4

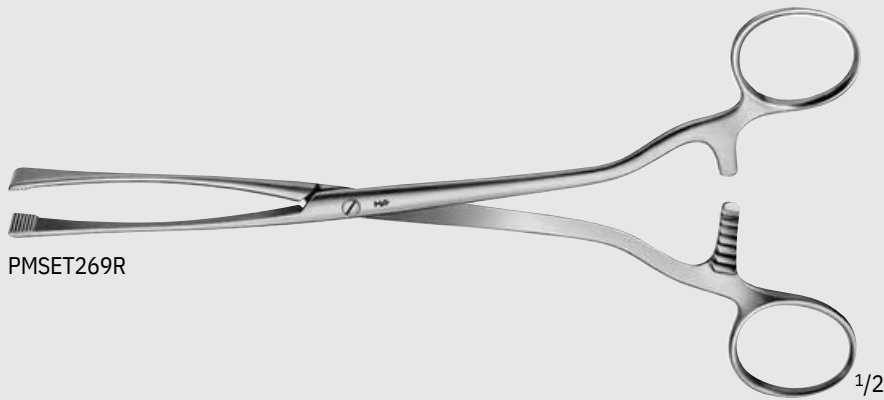

PMSET269R

8 3/4



PMSET269R

8 3/4

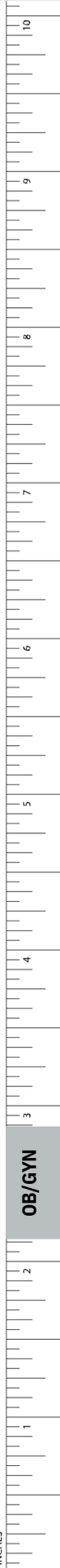

# Obstetrics/Gynecology

## Placenta and Ovum Forceps

### BARRETT Placenta Forceps

Catalog Number	Blade	Length (in.)
PMSMG201R	FENESTRATED	10

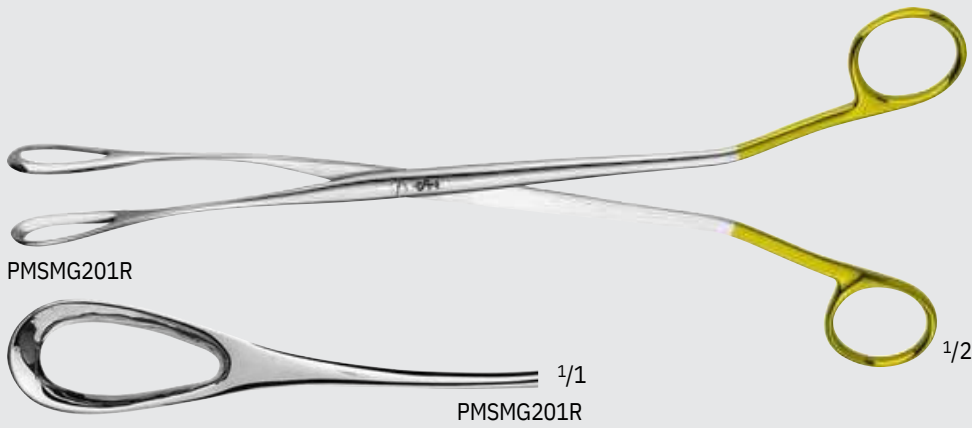

### BIERER Ovum Forceps

Catalog Number	Jaw (mm)	Ratchet	Length (in.)
PMSMG466R	16	NO	11
PMSMG467R	16	YES	11
PMSMG468R	19	NO	11
PMSMG469R	19	YES	11

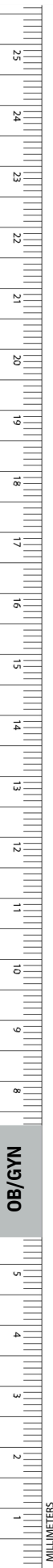
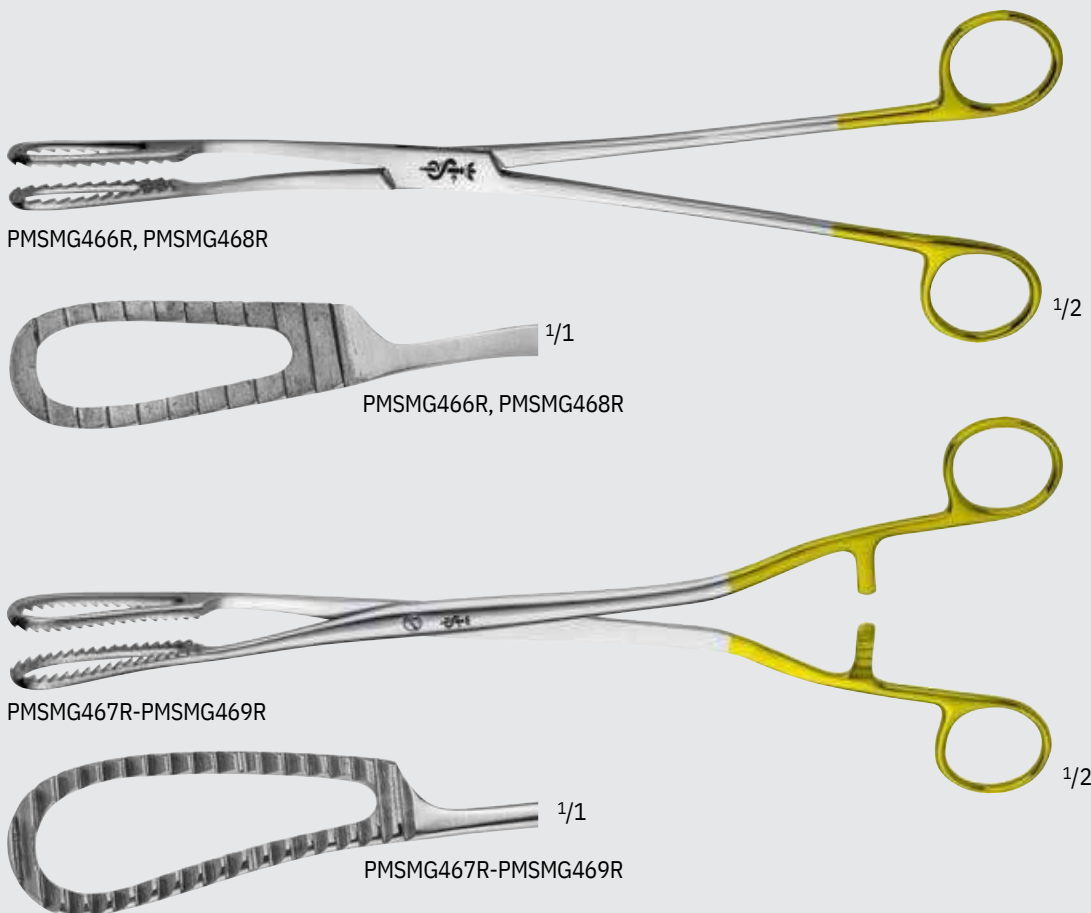

OB/GYN

**WINTER Placenta and Ovum Forceps,  
W/O Ratchet**

Catalog Number	Size (#)	Jaw	Length (in.)
PMSET301R	1	STR	11 1/2
PMSET302R	2	STR	11 1/2



PMSET301R-PMSET302R



PMSET301R



PMSET302R

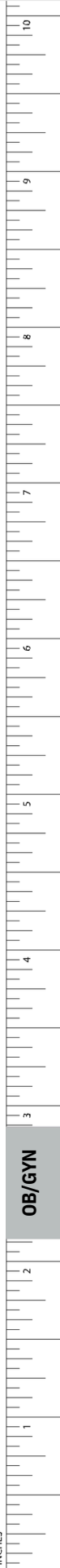

# Obstetrics/Gynecology

## Placenta and Ovum Forceps

### WINTER Placenta and Ovum Forceps, W/O Ratchet (continued)

Catalog Number	Size (#)	Jaw	Length (in.)
PMSET306F	1	CVD	11 1/2
PMSET307R	2	CVD	11 1/2
PMSET308F	3	CVD	11 1/2



PMSET306R-PMSET308R

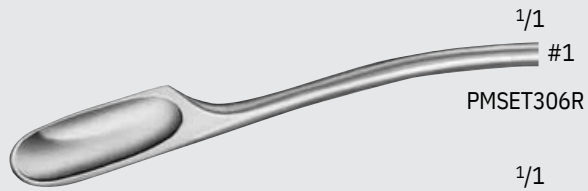

PMSET306R

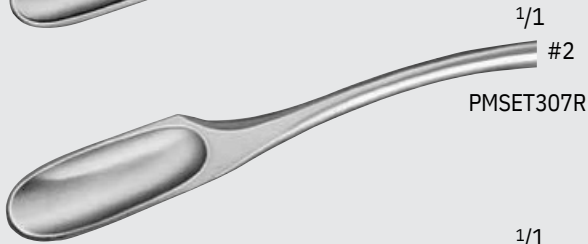

PMSET307R



PMSET308R

OB/GYN

**WINTER Placenta and Ovum Forceps,  
W/ Ratchet**

Catalog Number	Size (#)	Jaw	Length (in.)
PMSET315R	2	CVD	11 1/2
PMSET316R	3	CVD	11 1/2

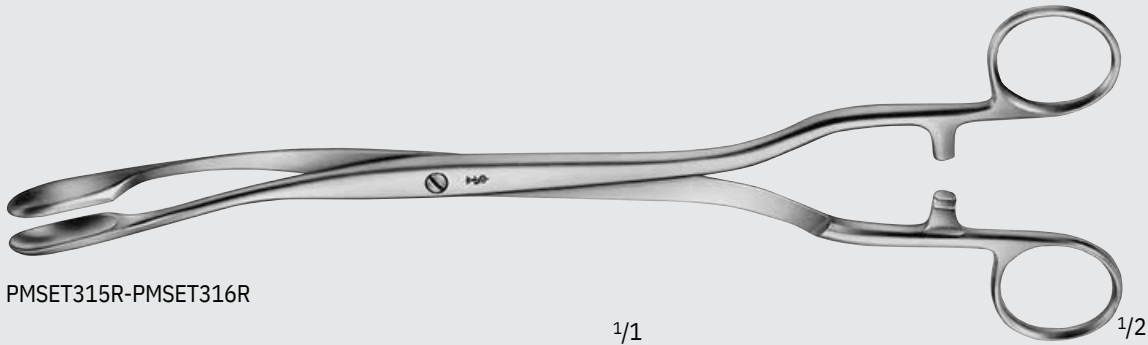

PMSET315R-PMSET316R



PMSET315R



PMSET316R

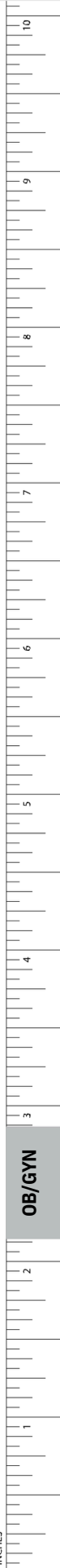

# Obstetrics/Gynecology

## Placenta and Ovum Forceps

### SAENGER Placenta and Ovum Forceps, W/ Ratchet

Catalog Number	Jaw	Length (in.)
PMSET326F	STR	10 3/4
PMSET327F	CVD	10 1/2
PMSET325F	CVD	11 1/4

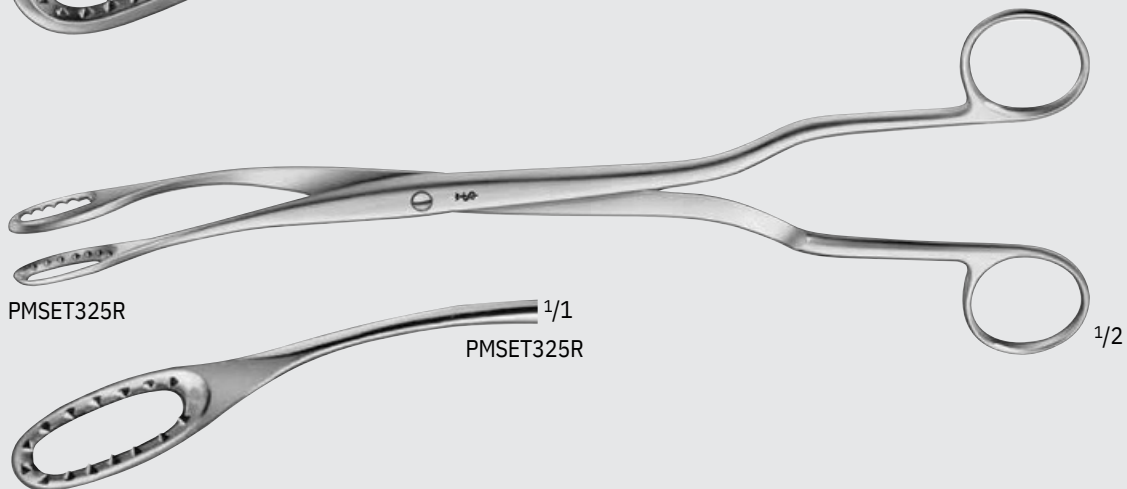
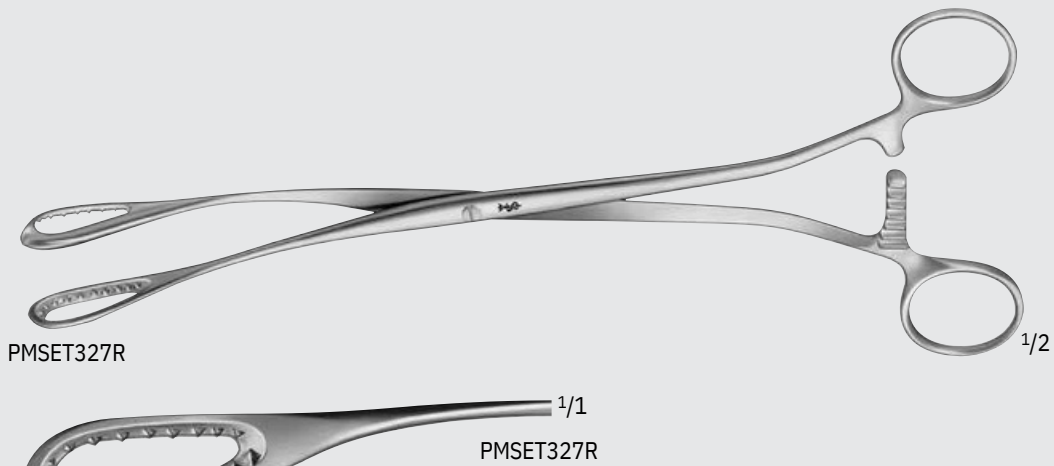
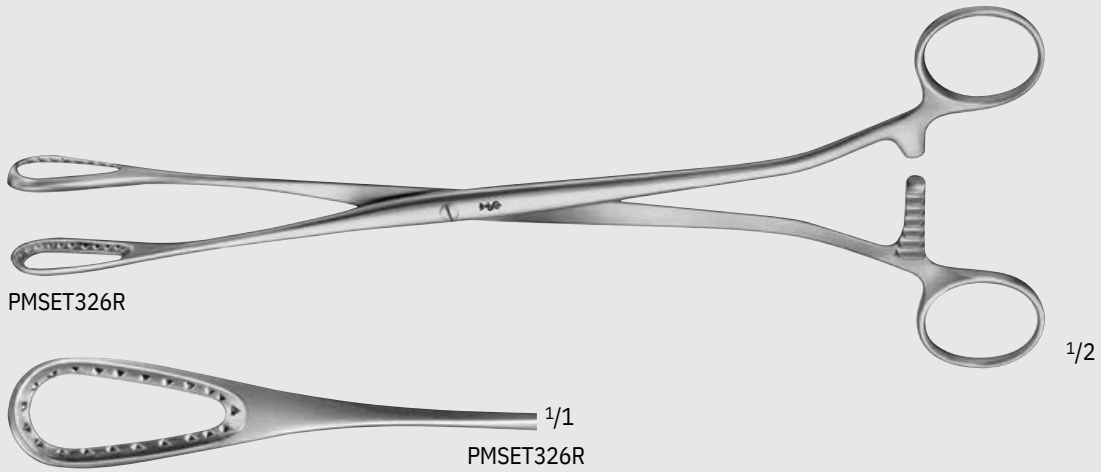

# Obstetrics/Gynecology

## Placenta and Ovum Forceps

### MCCLINTOCK Placenta and Ovum Forceps

Catalog Number	Length (in.)
PMSET329R	9 1/2

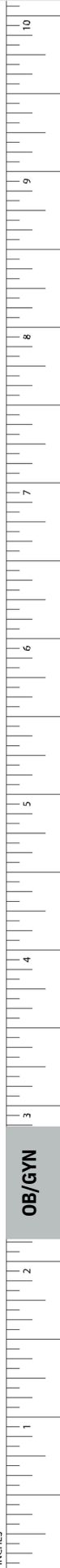

INCHES

OB/GYN

# Obstetrics/Gynecology

## Biopsy Forceps

### THOMS-GAYLOR Biopsy Forceps, S-Shape

Catalog Number	Length (in.)
PMSE050R	9 1/2

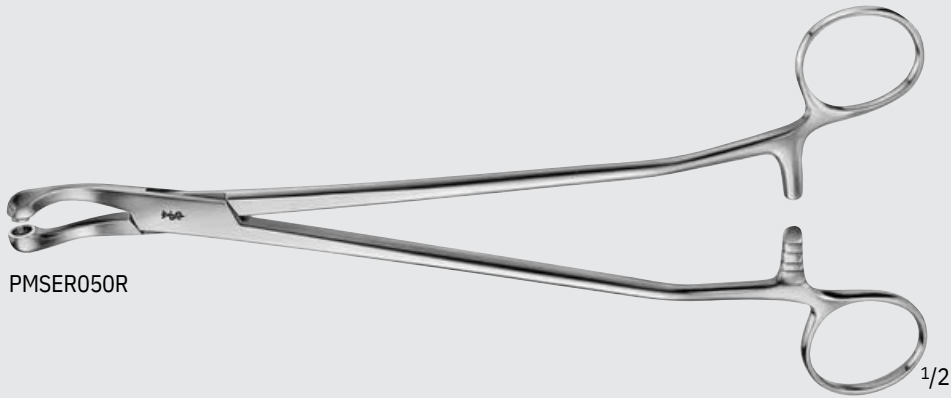

OB/GYN



**SCHUMACHER Biopsy Forceps, S-Shape**

Catalog Number	Tip	Length (in.)
PMSE061R	SMALL	9 1/2
PMSE062R	LARGE	9 1/2

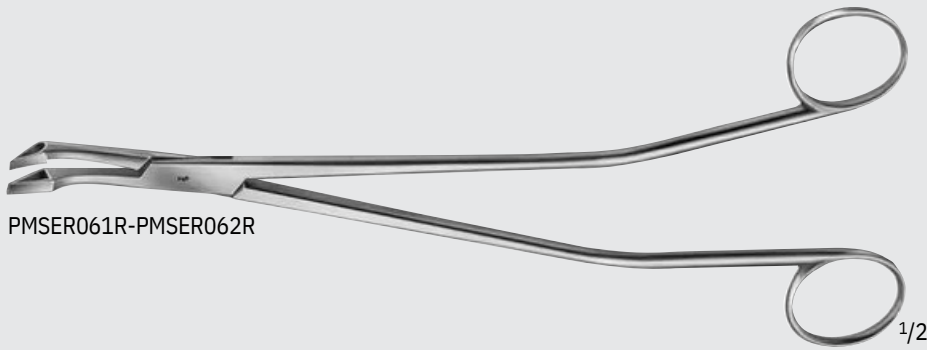

PMSE061R-PMSE062R



 1/1  
PMSE061R

 1/1  
PMSE062R

**SCHUMACHER Biopsy Rongeur**

Catalog Number	Tip	Length (in.)
PMSE063R	SMALL	9 1/2
PMSE064R	LARGE	9 1/2

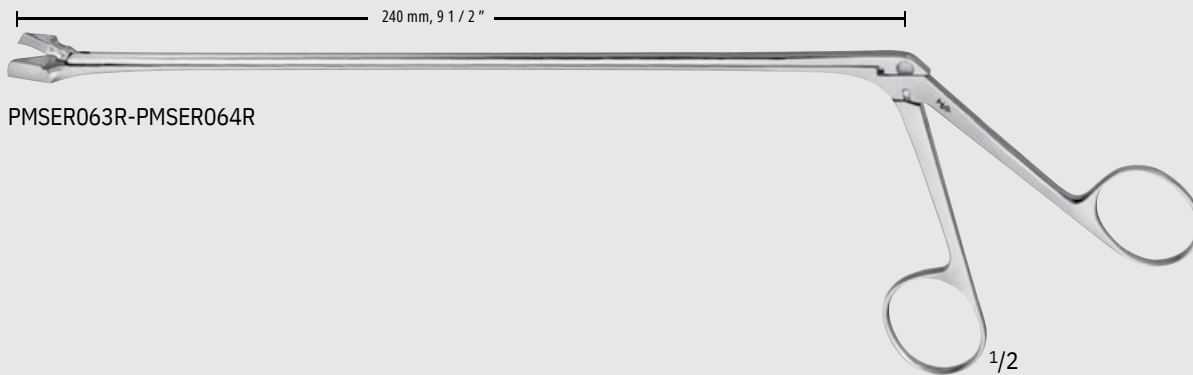

PMSE063R-PMSE064R



 1/1  
PMSE063R

 1/1  
PMSE064R

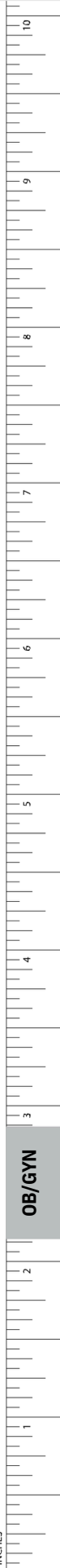

# Obstetrics/Gynecology

## Biopsy Forceps

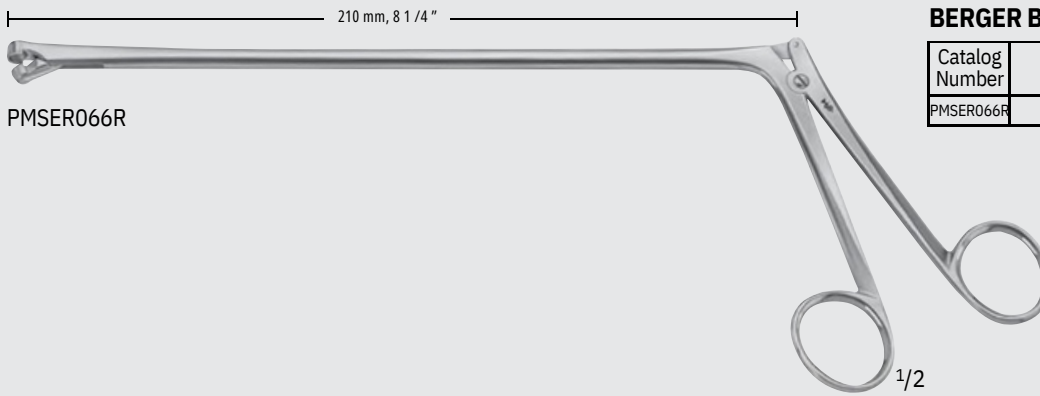

**BERGER Biopsy Forceps**

Catalog Number	Length (in.)
PMSER066R	8 1/4



PMSER066R

**TISCHLER Cervical Biopsy Punch Forceps**

Catalog Number	Jaw Size (mm)	Working Length (in.)
PMSER068R	5 x 6 x 3	8 1/4
PMSG187R	7 x 3	11

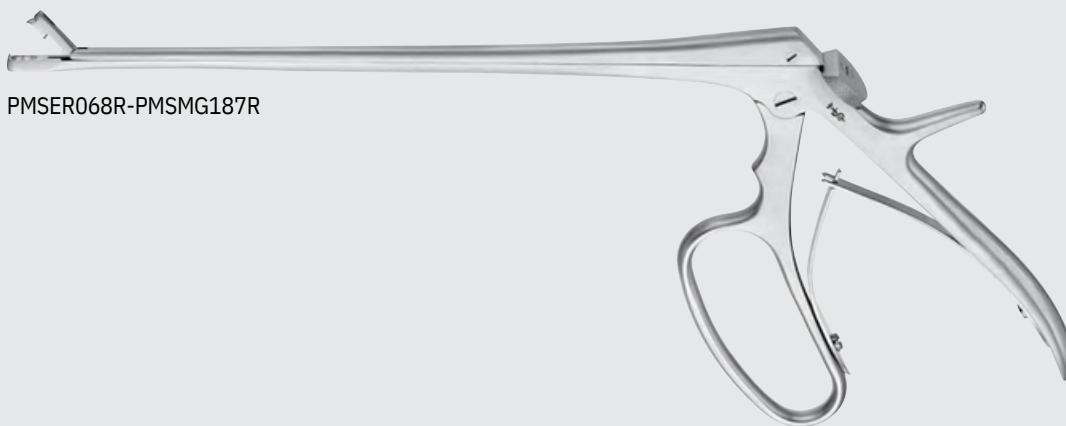

PMSER068R-PMSG187R

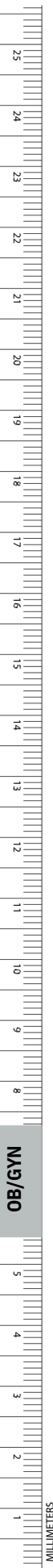

OB/GYN

**TISCHLER Biopsy Alligator Forceps**

Catalog Number	Jaw	Jaw Size (mm)	Length (in.)
PMSMG076R	OBLONG CUP SINGLE TOOTH	7 x 3	9 3/4



**KEVORKIAN-YOUNGE Biopsy Forceps**

Catalog Number	Jaw Size (mm)	Working Length (in.)
PMSE080R	8.5 x 3.5	10

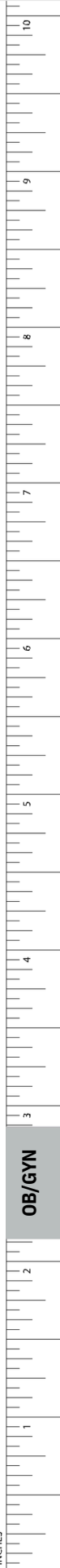
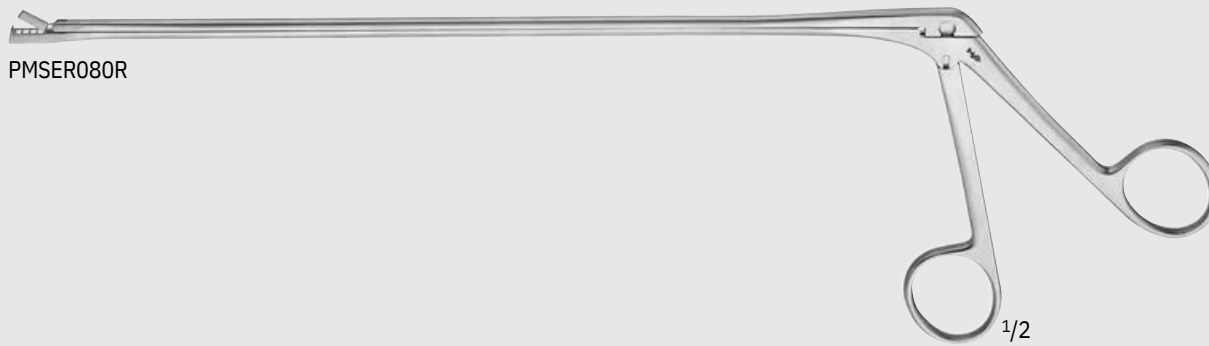

INCHES

OB/GYN

# Obstetrics/Gynecology

## Biopsy Forceps

### WITTNER Biopsy Forceps

Catalog Number	Jaw	Jaw Size (mm)	Working Length (in.)
PMSMG194R	STR. JAWS W/ TEETH	4 x 8	9

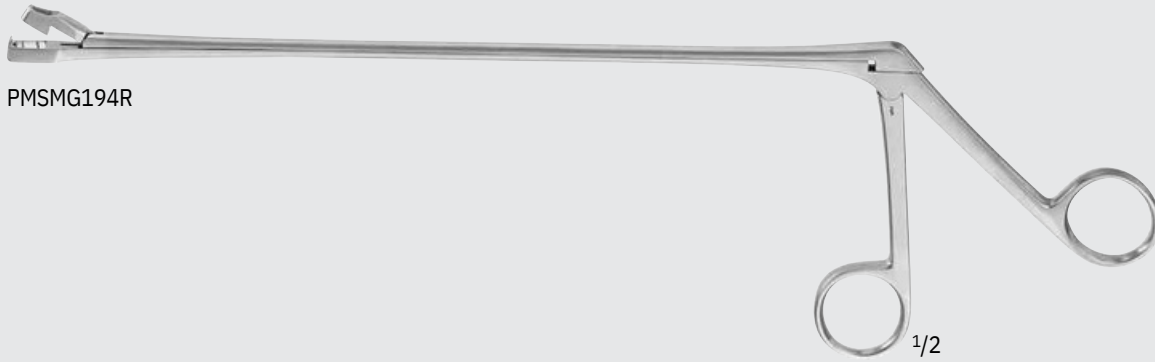

### EPPENDORF Biopsy Forceps

Catalog Number	Jaw Size (mm)	Working Length (in.)
PMSER070R	8 x 4	8

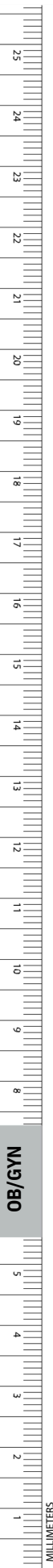
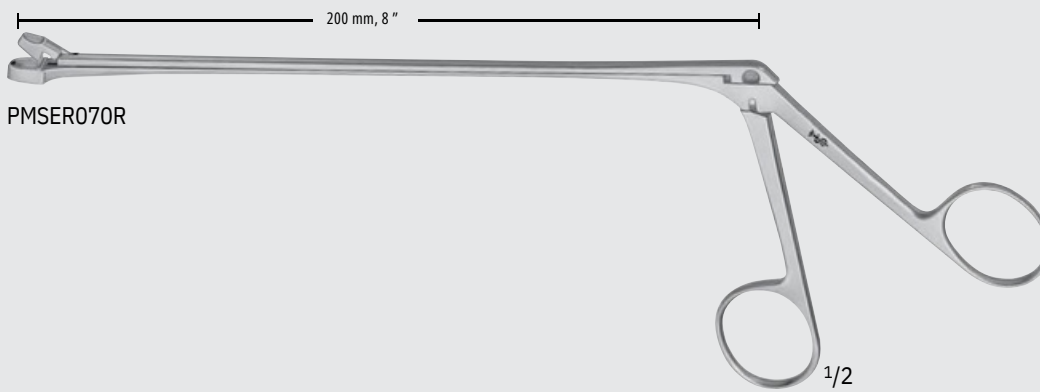

OB/GYN

**PHANEUF Hysterectomy Forceps**

Catalog Number	Jaw	Length (in.)
PMSBJ500R	STR	8 1/4
PMSBJ501R	ANG	8

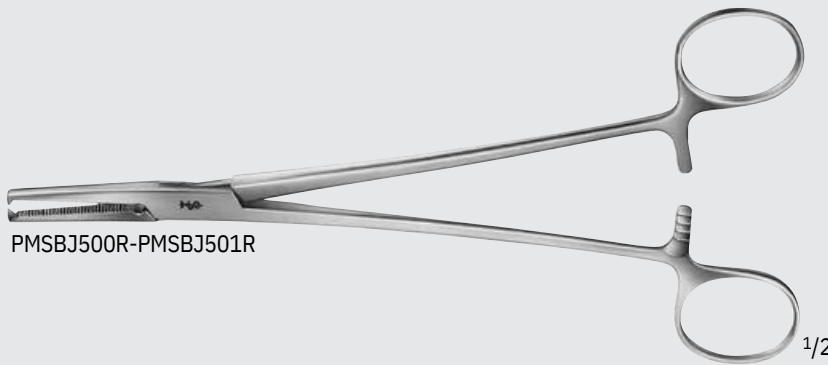

PMSBJ500R-PMSBJ501R



1/1



1/1

PMSBJ500R



1/1

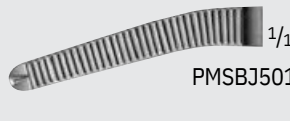

PMSBJ501R

1/2

**HOLZBACH Hysterectomy Forceps**

Catalog Number	Jaw	Length (in.)
PMSBJ510R	STR	9 5/8
PMSBJ511R	CVD	9 5/8

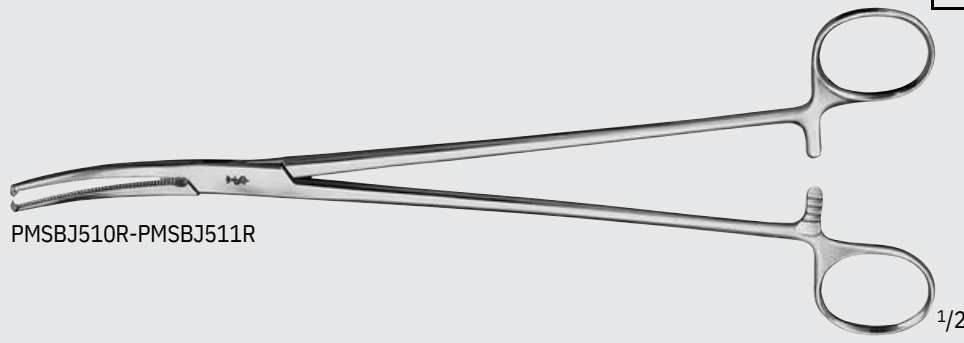

PMSBJ510R-PMSBJ511R



1/1



1/1

PMSBJ510R



1/1



PMSBJ511R

1/2

**HEANEY-REZEK Hysterectomy Forceps**

Catalog Number	Jaw	Length (in.)
PMSBJ524R	STR	8 1/4

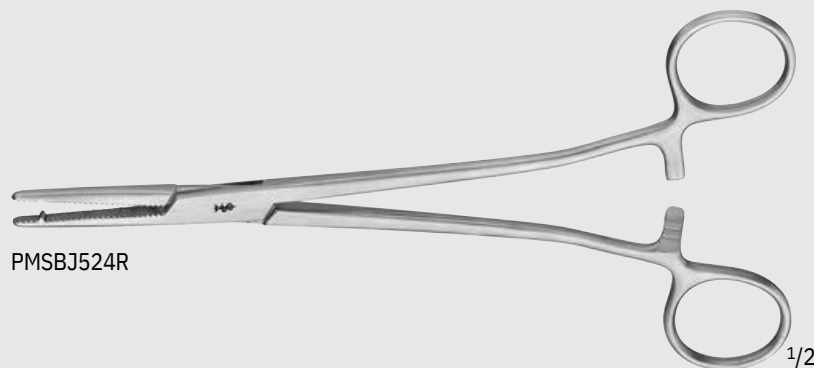

PMSBJ524R



1/1

PMSBJ524R

1/2



OB/GYN

INCHES

# Obstetrics/Gynecology

## Clamps

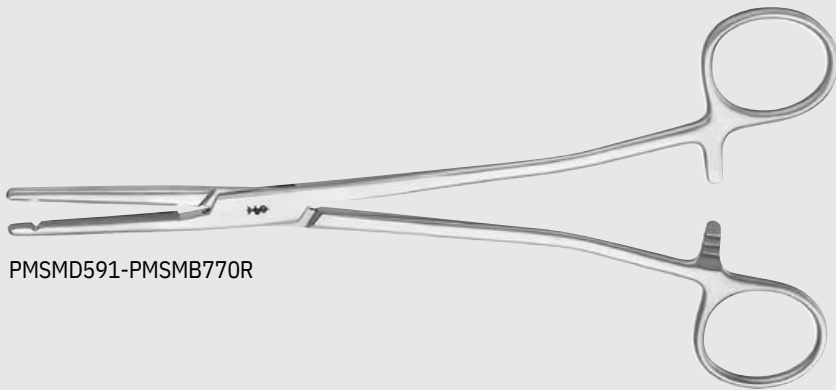

PMSMD591-PMSMB770R

### HEANEY-BALLENTINE Hysterectomy Forceps, Longitudinal Grooves

Catalog Number	Jaw	Length (in.)
PMSMD591	STR	8 1/2
PMSMB757R	STR	10 1/2
PMSMB754R	STR	12
PMSMB771R	STR	14
PMSMD592	CVD	8 1/2
PMSMB749R	CVD	10 1/2
PMSMB753R	CVD	12
PMSMB770R	CVD	14



PMSMD591

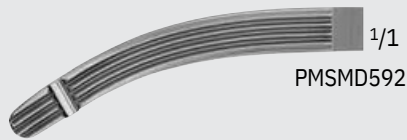

PMSMD592

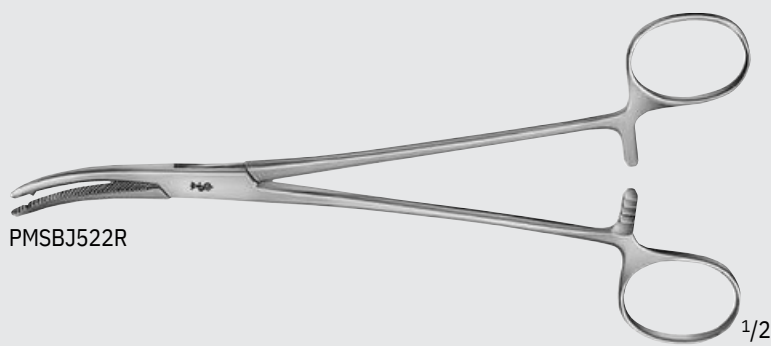

PMSBJ522R

### HEANEY Hysterectomy Forceps

Catalog Number	Jaw	Teeth	Length (in.)
PMSBJ522R	CVD	1	7 3/4
PMSBJ520R	CVD	2	8
PMSBJ521R	CVD	2	9 3/4

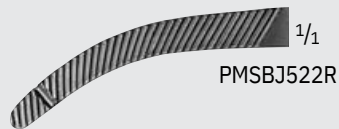

PMSBJ522R



PMSBJ520R-PMSBJ521R

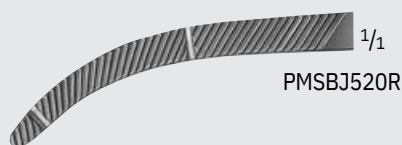

PMSBJ520R

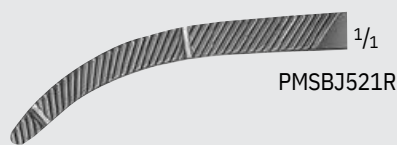

PMSBJ521R

OB/GYN

**HEANEY Hysterectomy Forceps (continued)**

Catalog Number	Jaw	Teeth	Length (in.)
PMSMB906R	STR	2	12
PMSMB907R	CVD	2	12

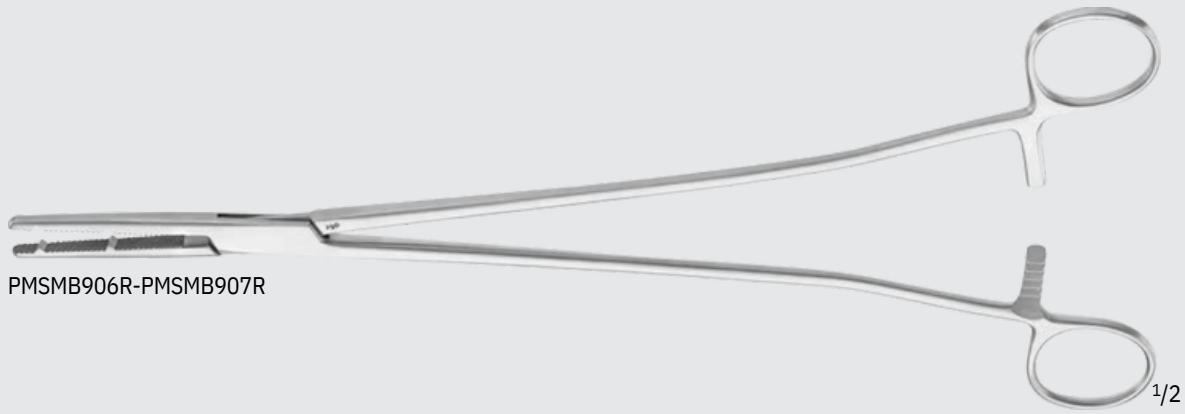

PMSMB906R-PMSMB907R



PMSMB906R



PMSMB907R

**HEANEY Hysterectomy Forceps, Heavy**

Catalog Number	Jaw	Length (in.)
PMSMB797R	CVD	8 1/4

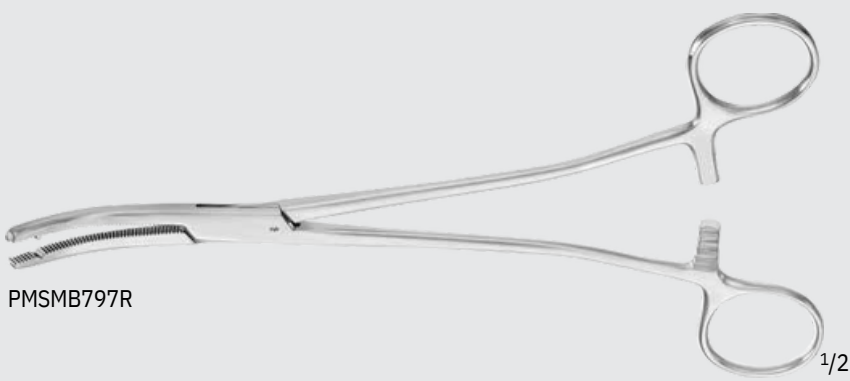

PMSMB797R

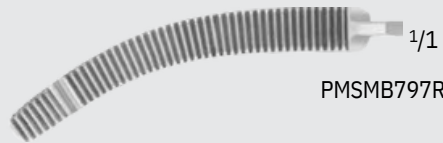

PMSMB797R



# Obstetrics/Gynecology

## Clamps

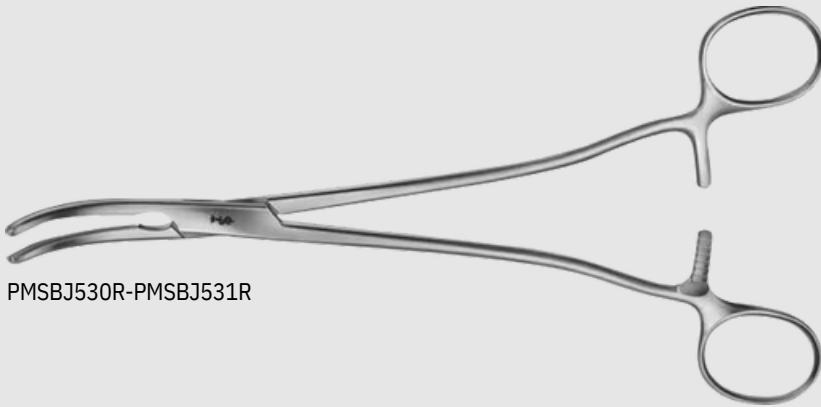

PMSBJ530R-PMSBJ531R

### HEANEY Hysterectomy Forceps, W/O Teeth

Catalog Number	Jaw	Length (in.)
PMSBJ530R	STR	8 7/8
PMSBJ532R	CVD	8 1/2
PMSBJ531R	CVD	8 3/4



PMSBJ530R

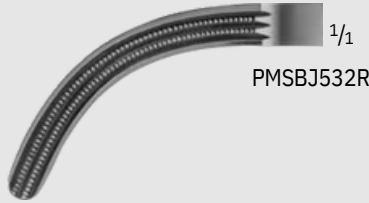

PMSBJ532R



PMSBJ531R

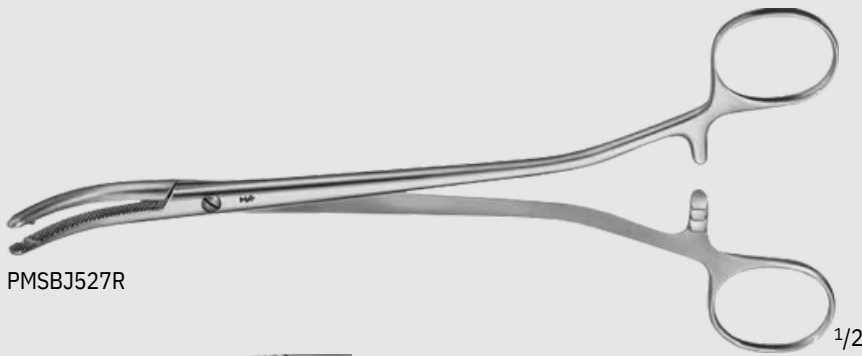

PMSBJ527R

### WIENER Hysterectomy Forceps, W/ Grooves

Catalog Number	Tip	Jaw	Length (in.)
PMSBJ527R	SMOOTH	CVD	9 1/2

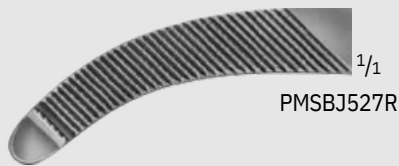

PMSBJ527R

OB/GYN



**WERTHEIM Atraumatic Parametrium Clamp**

Catalog Number	Jaw	Length (in.)
PMSBJ550R	STR	9 3/4
PMSBJ551R	SLT-CVD	9 5/8
PMSBJ552R	CVD	9 1/2
PMSBJ553R	UP-CVD	8 3/4

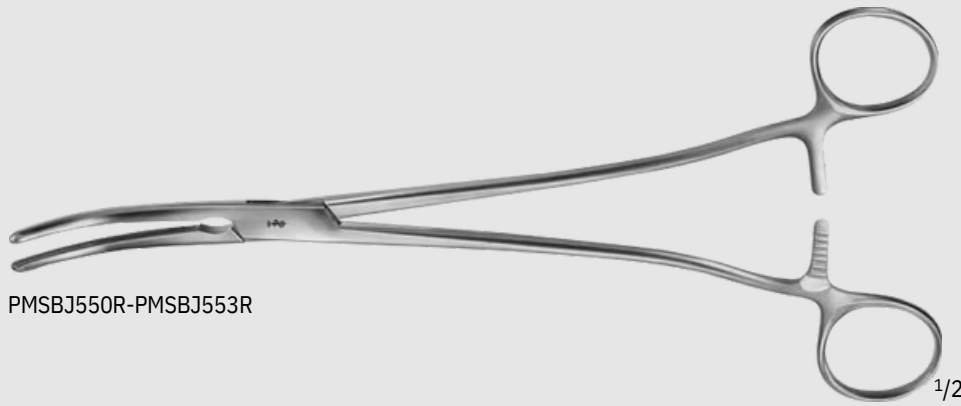

PMSBJ550R-PMSBJ553R



PMSBJ550R



PMSBJ551R



PMSBJ552R

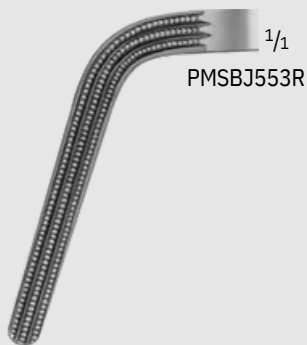

PMSBJ553R



OB/GYN

# Obstetrics/Gynecology

## Clamps

### WERTHEIM Parametrium Clamp

Catalog Number	Jaw	Length (in.)
PMSBJ576R	CVD	10 1/4

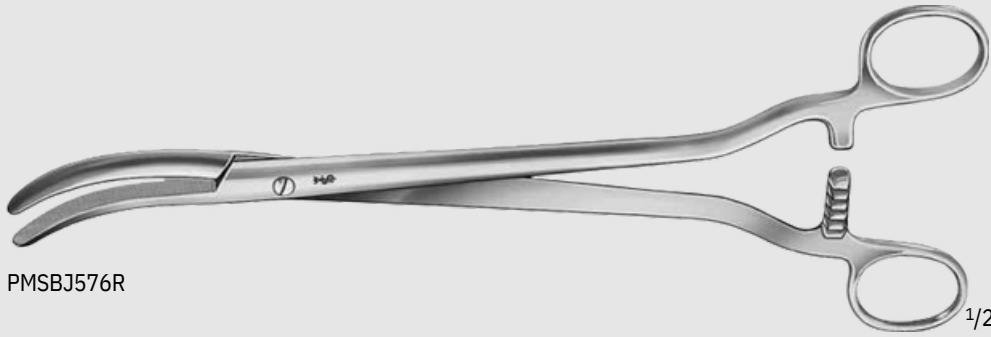

PMSBJ576R

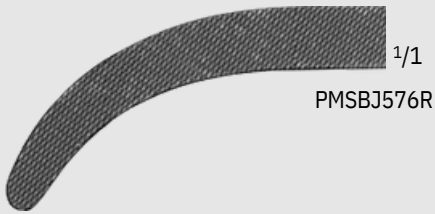

PMSBJ576R

### WERTHEIM Hysterectomy Forceps

Catalog Number	Jaw	Length (in.)
PMSBJ574R	CVD	10

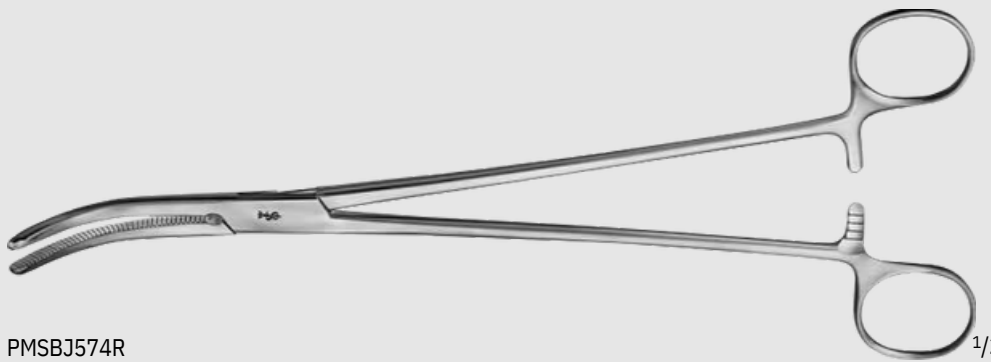

PMSBJ574R



PMSBJ574R

OB/GYN

MILLIMETERS

**WERTHEIM-CULLEN Clamp**

Catalog Number	Jaw	Length (in.)
PMSBJ579R	RIGHT-ANG	8 1/2

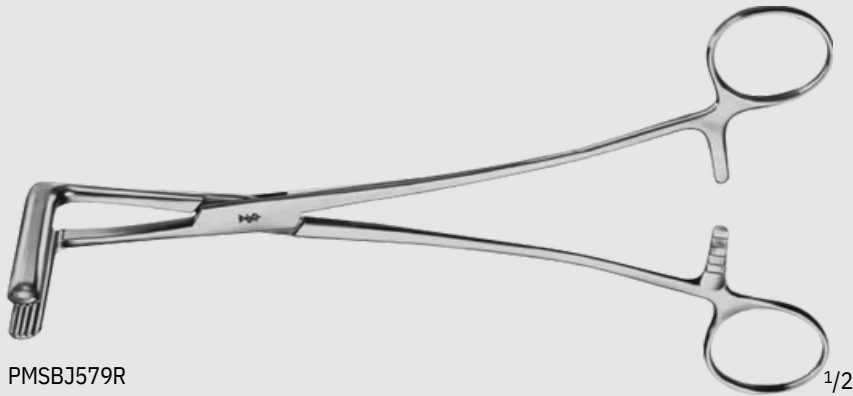

PMSBJ579R

1/2



PMSBJ579R

1/1

**WERTHEIM Atraumatic Clamp**

Catalog Number	Jaw	Length (in.)
PMSBJ581R	RIGHT-ANG	9 3/4

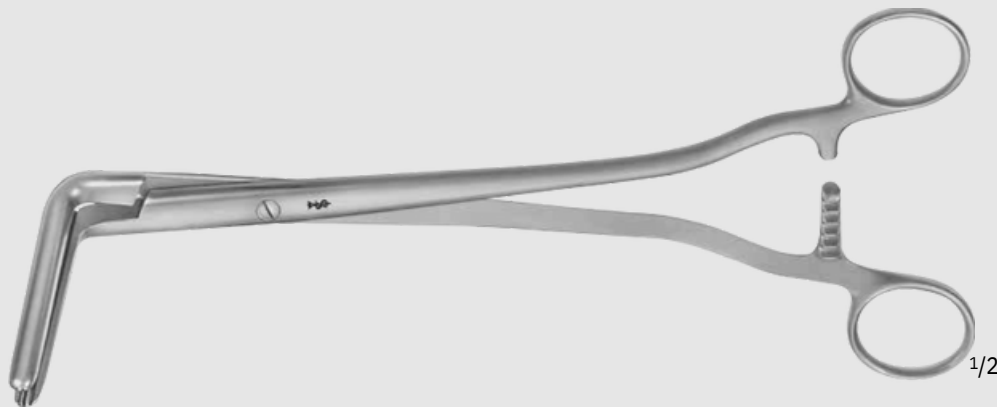

PMSBJ581R

1/2



# Obstetrics/Gynecology

## Clamps

### GLASSMAN Anterior Resection Clamp

Catalog Number	Jaw	Jaw Length (mm)	Length (in.)
PMSMB931R	90°, SERR	25	9 3/4
PMSMB130R	90°, SERR	50	9 3/4
PMSMB932R	90°, SERR	75	10

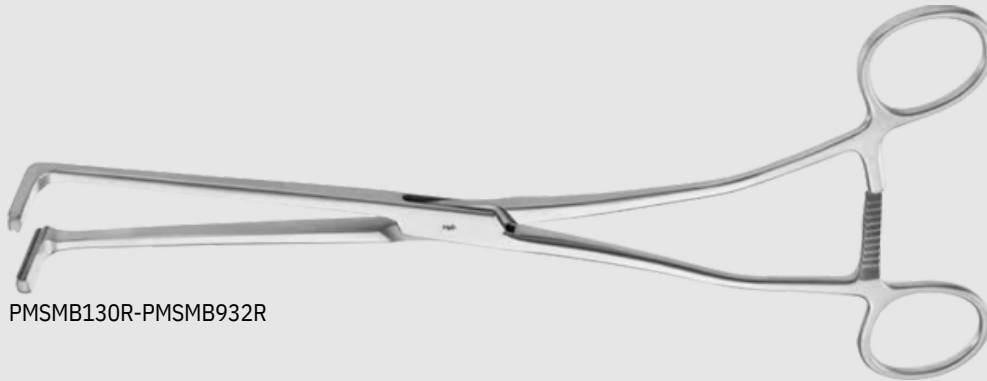

PMSMB130R-PMSMB932R



1/1  
PMSMB931R

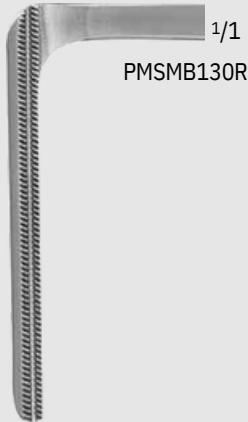

1/1  
PMSMB130R

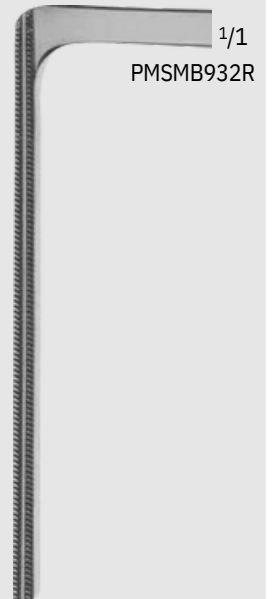

1/1  
PMSMB932R

### MASTERSON Uterine Clamp

Catalog Number	Jaw	Length (in.)
PMSMG198R	STR	8 1/2
PMSMG199R	CVD	8 1/2

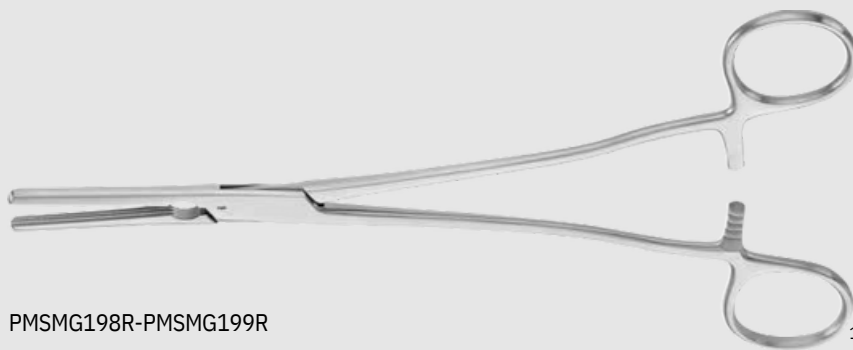

PMSMG198R-PMSMG199R



1/1  
PMSMG198R

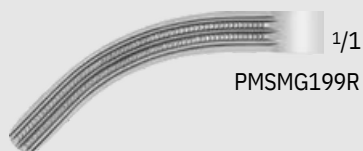

1/1  
PMSMG199R

OB/GYN

Z-Type Hysterectomy Clamp

Catalog Number	Jaw	Handle	Length (in.)
PMSMG203R	STR	STR	8 1/2
PMSMG204R	SLIGHT-CVD	STR	8 1/2
PMSMG205R	CVD	STR	8 1/2
PMSMG206R	ANG	STR	8 1/2
PMSMB352R	STR	STR	9 1/2
PMSMB353R	SLIGHT-CVD	STR	9 1/2
PMSMB354R	CVD	STR	9 1/2
PMSMB355R	ANG	STR	9 1/2
PMSMB786R	STR	ANG	9 1/2
PMSMB787R	SLIGHT-CVD	ANG	9 1/2
PMSMB788R	CVD	ANG	9 1/2
PMSMB789R	ANG	ANG	9 1/2
PMSMB187R	STR	STR	12
PMSMB188R	SLIGHT-CVD	STR	12
PMSMB183R	CVD	STR	12
PMSMB184R	ANG	STR	12
PMSMB790R	STR	ANG	12
PMSMB792R	SLIGHT-CVD	ANG	12
PMSMB793R	CVD	ANG	12
PMSMB794R	ANG	ANG	12

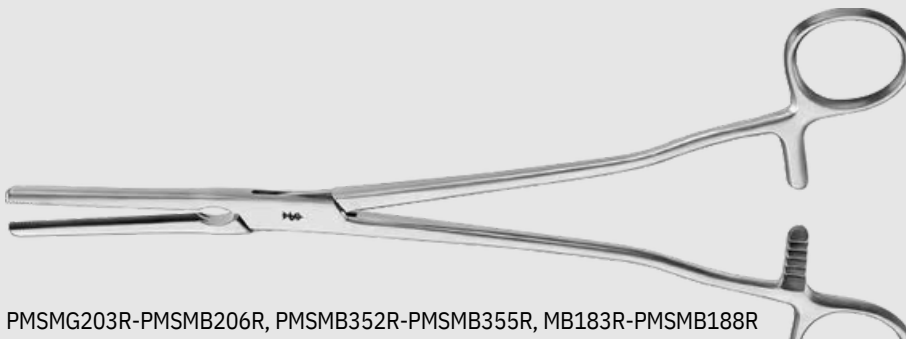

PMSMG203R-PMSMB206R, PMSMB352R-PMSMB355R, MB183R-PMSMB188R

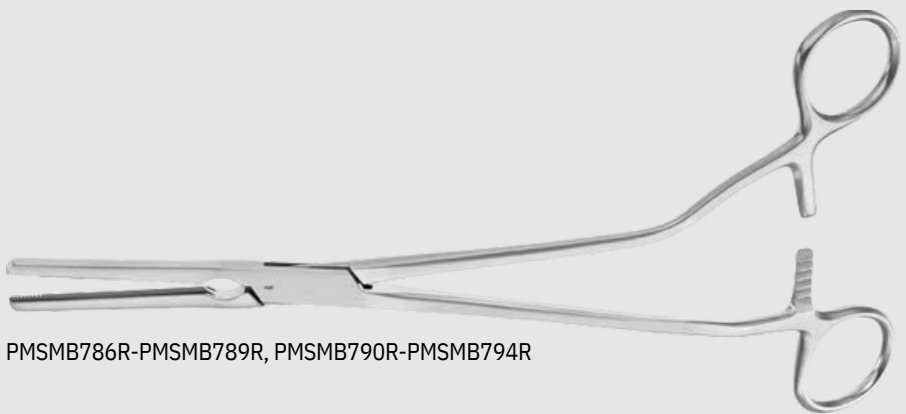

PMSMB786R-PMSMB789R, PMSMB790R-PMSMB794R



1/1

PMSMG203R, PMSMB352R, PMSMB786R, PMSMB187R, PMSMB790R



1/1

PMSMG204R, PMSMB353R, PMSMB787R, PMSMB188R, PMSMB792R

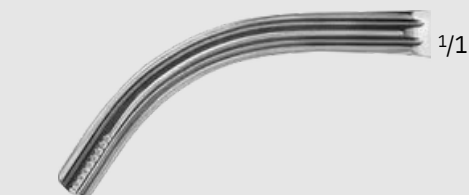

1/1

PMSMG205R, PMSMB354R, PMSMB788R, PMSMB183R, PMSMB793R



1/1

PMSMG206R, PMSMB355R, PMSMB789R, PMSMB184R, PMSMB794R



OB/GYN

INCHES

# Obstetrics/Gynecology

## Clamps

### Z-Type Hysterectomy Clamp (continued)

Catalog Number	Jaw	Handle	Length (in.)
PMSMB185R	STR	STR	14
PMSMB186R	SLT-CVD	STR	14
PMSMB987R	CVD	STR	14
PMSMB988R	ANG	STR	14

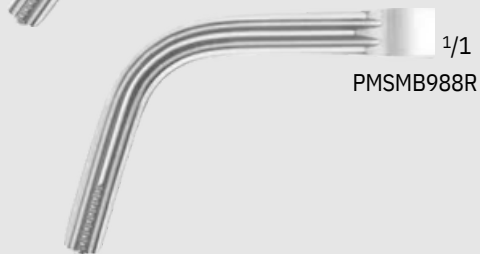
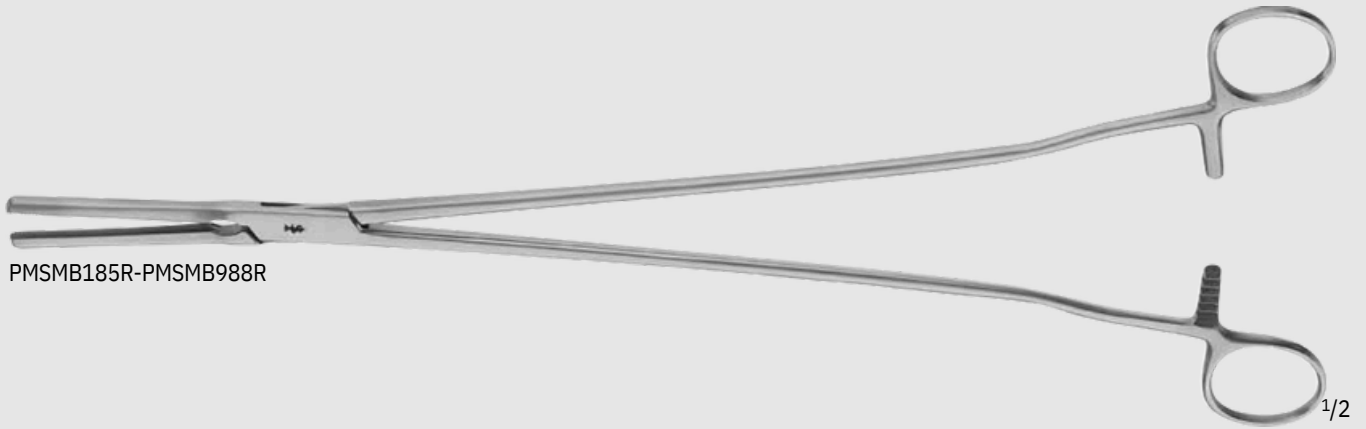

OB/GYN

# Obstetrics/Gynecology

## Perineal and Vaginal Retractors

### GELPI Perineal Retractor W/ Ball Stop

Catalog Number	Length (in.)
PMSMB199R	7

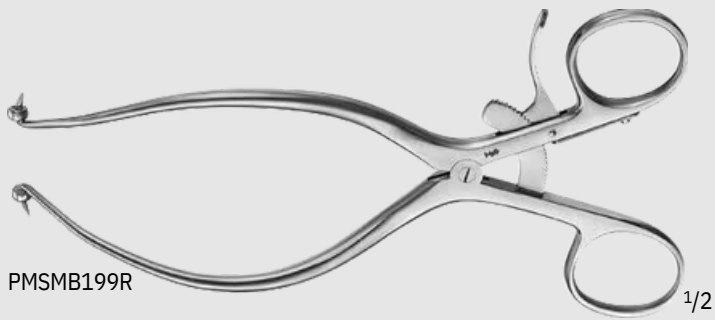

PMSMB199R

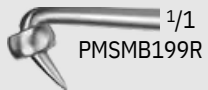

<sup>1</sup>/<sub>1</sub>  
PMSMB199R

### GELPI Vaginal Retractor

Catalog Number	Tip	Length (in.)
PMSG176R	SHARP	3 1/2
PMSBV996R	SHARP	5 1/4
PMSBV997R	SHARP	6 7/8
PMSMD651	SHARP	7 1/4
PMSG177R	BLUNT	4 1/2



PMSG176R, PMSG177R,  
PMSBV996R, PMSMD651

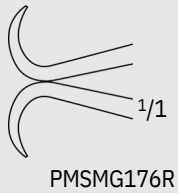

<sup>1</sup>/<sub>1</sub>  
PMSG176R

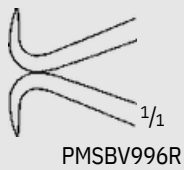

<sup>1</sup>/<sub>1</sub>  
PMSBV996R

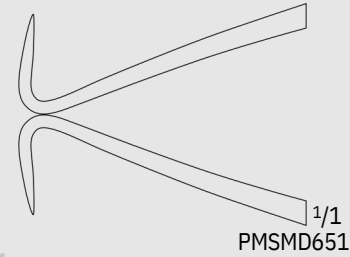

<sup>1</sup>/<sub>1</sub>  
PMSMD651



<sup>1</sup>/<sub>1</sub>  
PMSG177R



PMSBV997R

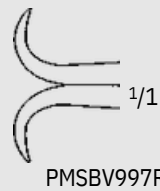

<sup>1</sup>/<sub>1</sub>  
PMSBV997R

### RIGBY Vaginal Retractor

Catalog Number	Length (in.)
PMSMB267R	7 1/2



PMSMB267R



OB/GYN

INCHES

# Obstetrics/Gynecology

## Retractors



### DELEE Universal Retractor

Catalog Number	Length (in.)
PMSMB068R	9 1/2

PMSMB068R



### O' SULLIVAN-O' CONNOR Retractor

Catalog Number	Description	Blade Size (mm)
PMSUS100	COMPLETE	185 x 143
PMSUS100201	SMALL BLADE	80 x 149
PMSUS100202	LARGE BLADE	155 x 110

PMSUS100 Includes:  
 1 Retractor PMSUS100200  
 2 Blades PMSUS100201  
 and  
 1 Blade PMSUS100202

PMSUS100-PMSUS100202



PMSUS100201



PMSUS100202

OB/GYN

MILLIMETERS



# Obstetrics/Gynecology

## Vaginal Retractors and Specula

### COLLIN Vaginal Specula

Catalog Number	Blade Size (mm)
PMSELO11R	95/85 x 18



PMSELO11R

### CUSCO Vaginal Specula

Catalog Number	Blade Size (mm)
PMSELO40R	75 x 17

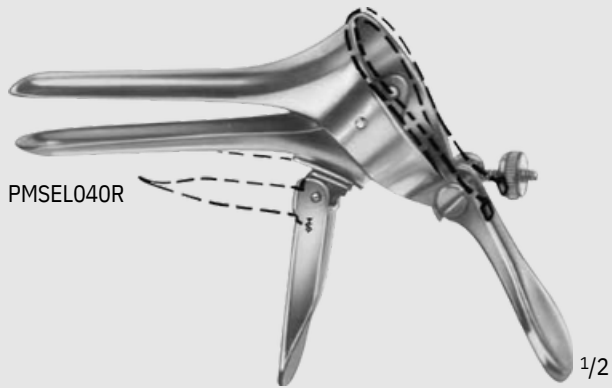

PMSELO40R

### CUSCO Vaginal Specula

Catalog Number	Blade Size (mm)
PMSELO42R	80 x 32
PMSELO43R	90 x 36
PMSELO44R	110 x 37

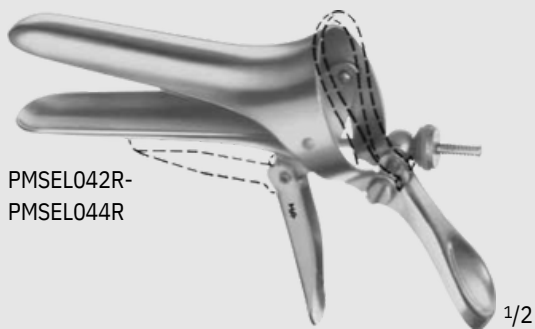

PMSELO42R-  
PMSELO44R



OB/GYN

INCHES

# Obstetrics/Gynecology

## Vaginal Retractors and Specula

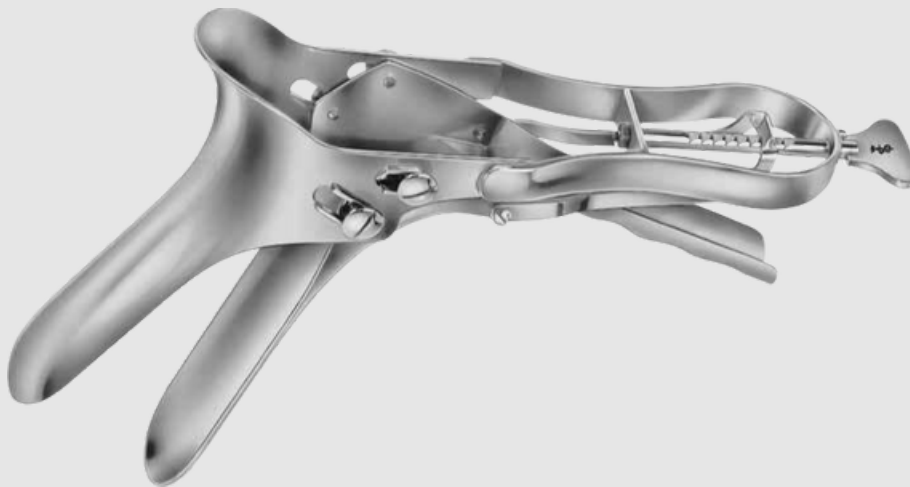

PMSSEL180R-PMSSEL181R

### SEYFFERT Vaginal Specula

Catalog Number	Blade Size (mm)	Length (in.)
PMSSEL180R	100 x 17	9
PMSSEL181R	110 x 33	9

1/2

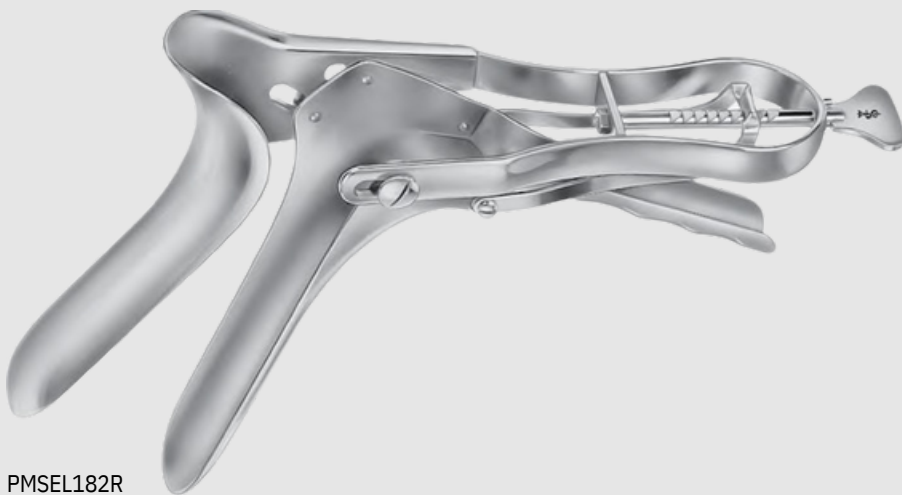

PMSSEL182R

### SEYFFERT Speculum, 1 Side Open

Catalog Number	Blade Size (mm)	Length (in.)
PMSSEL182R	110 x 33	9

1/2



PMSSEL183R

### SEMM Vaginal Specula, 45° Angle

Catalog Number	Blade Size (mm)	Length (in.)
PMSSEL183R	90 x 14	7

1/2

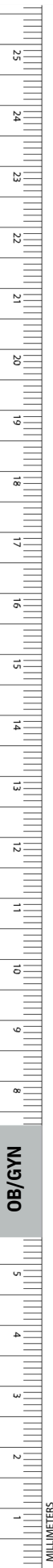

# Obstetrics/Gynecology

## Vaginal Retractors and Specula



PMSMB066R-PMSEL193R

### PEDERSON Vaginal Speculum

Catalog Number	Blade Size (mm)
PMSMB066R	75 x 12.7
PMSEL192R	100 x 22
PMSMG156R	115 x 16
PMSEL193R	120 x 25



# Obstetrics/Gynecology

## Vaginal Retractors and Specula



PMSMB067R

### PEDERSON Vaginal Speculum, Large, Insulated Coating, W/ Evacuation Vent

Catalog Number	Blade Size (mm)
PMSMB067R	120 x 25



PMSSEL194R-PMSMG159R

### GRAVES Vaginal Speculum

Catalog Number	Blade Size (mm)
PMSSEL194R	75 x 20
PMSSEL195R	95 x 30
PMSSEL196R	105 x 33
PMSMG159R	125 x 40
PMSMB841R	102 x 34 W/ SIDE OPENING



PMSMB841R

OB/GYN

# Obstetrics/Gynecology

## Vaginal Retractors and Specula

### KRISTELLER Vaginal Speculum, Set of 2 each

Catalog Number	Blade Size (mm)	Length (in.)
PMSEL420R	70 x 15	6 3/4
PMSEL421R	70 x 27	6 7/8
PMSEL422R	75 x 30	6 7/8
PMSEL423R	90 x 36	6 7/8
PMSEL426R	110 x 20	8 3/4
PMSEL425R	110 x 27	8 3/4
PMSEL427R	110 x 30	8 3/4
PMSEL428R	110 x 36	8 3/4

Each blade size comes as a set of 2 - with one upper and one lower blade

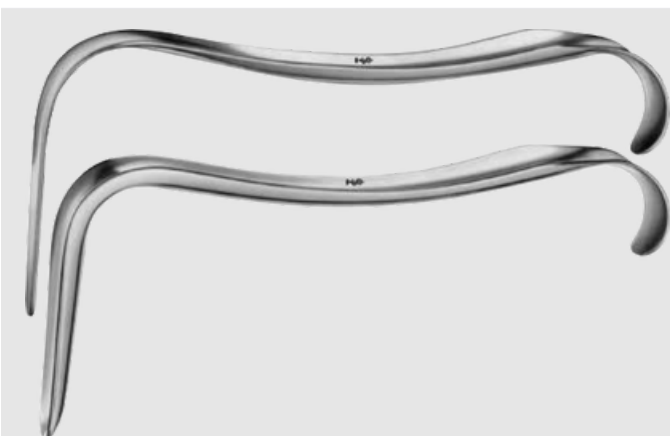

PMSEL420R-PMSEL428R



# Obstetrics/Gynecology

## Vaginal Retractors and Specula



PMSEL450R-PMSEL458R

### KRISTELLER Vaginal Specula Upper Blades

Catalog Number	Blade Size (mm)	Length (in.)
PMSEL450R	75 x 10	6 7/8
PMSEL451R	75 x 23	7
PMSEL452R	80 x 25	7
PMSEL453R	100 x 32	7 1/4
PMSEL454R	115 x 14	8 1/2
PMSEL455R	115 x 23	8 1/2
PMSEL457R	115 x 26	8 3/4
PMSEL458R	120 x 30	8 7/8



PMSEL450R <sup>1/1</sup>



PMSEL451R <sup>1/1</sup>



PMSEL452R <sup>1/1</sup>



PMSEL453R <sup>1/1</sup>



PMSEL454R <sup>1/1</sup>



PMSEL455R <sup>1/1</sup>



PMSEL457R <sup>1/1</sup>



PMSEL458R <sup>1/1</sup>

OB/GYN

MILLIMETERS

**Obstetrics/Gynecology**  
Vaginal Retractors and Specula

**KRISTELLER Vaginal Specula Lower Blades**

Catalog Number	Blade Size (mm)	Length (in.)
PMSEL440R	70 x 15	6 7/8
PMSEL441R	70 x 27	7
PMSEL442R	75 x 30	7
PMSEL443R	90 x 36	7 1/4
PMSEL444R	110 x 18	8 1/2
PMSEL445R	110 x 27	8 1/2
PMSEL446R	110 x 20	8 3/4
PMSEL447R	110 x 30	8 3/4
PMSEL448R	110 x 36	8 7/8



PMSEL440R-PMSEL448R



PMSEL440R



PMSEL441R



PMSEL442R



PMSEL443R



PMSEL444R



PMSEL445R



PMSEL446R



PMSEL447R



PMSEL448R

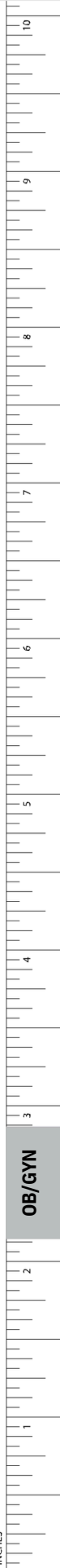

# Obstetrics/Gynecology

## Vaginal Retractors and Specula



### KALLMORGEN Vaginal Specula Set of 2

Catalog Number	Blade Size (mm)	Length (in.)
PMSEL480R	75 x 39	6 3/4

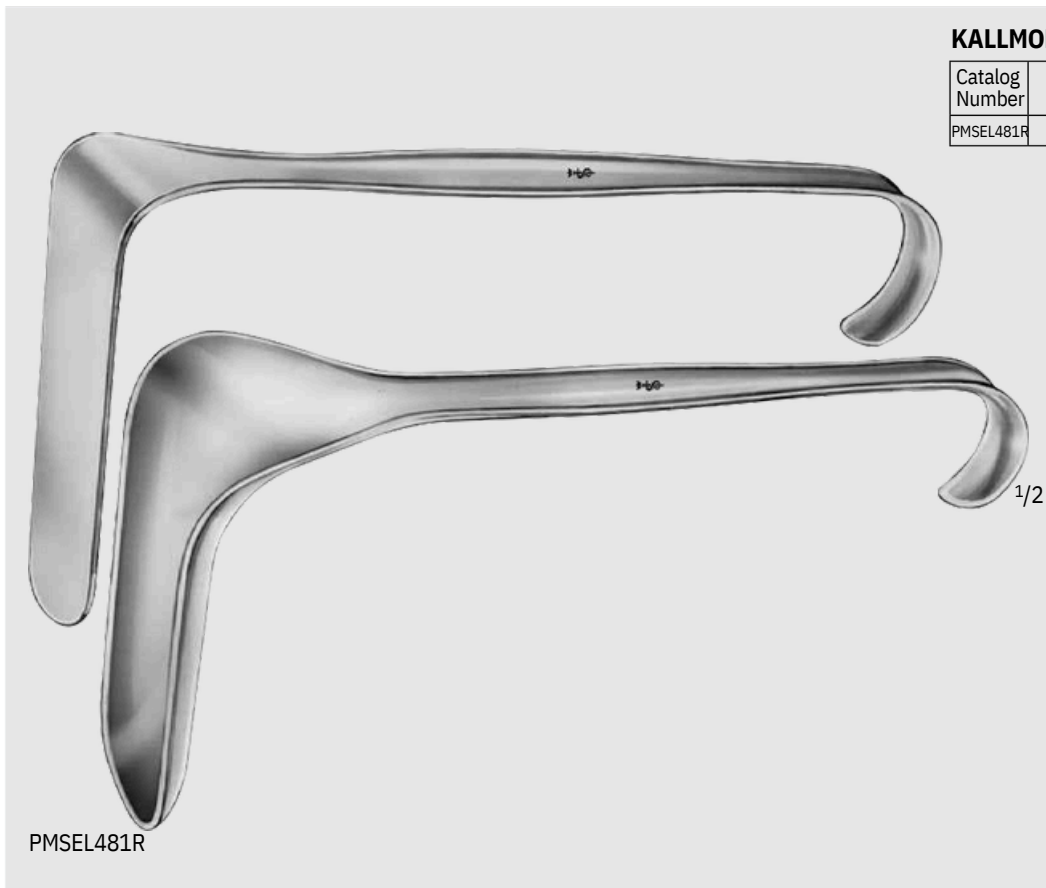

### KALLMORGEN Vaginal Specula Set of 2

Catalog Number	Blade Size (mm)	Length (in.)
PMSEL481R	95 x 39	7 7/8



# Obstetrics/Gynecology

## Vaginal Retractors and Specula



PMSMB759R-PMSMB761R

### SIMS Vaginal Retractor

Catalog Number	Blade Size (mm)
PMSMB759R	70 x 25
PMSMB760R	76 x 32
PMSMB761R	89 x 38



PMSMG158R-PMSEL409R

### SIMS Vaginal Speculum, Double Ended

Catalog Number	Blade Size (mm)	Length (in.)
PMSMG158R	69 x 25 / 70 x 30	5
PMSEL407R	70 x 26 / 75 x 30	5
PMSEL408R	75 x 30 / 80 x 35	6
PMSEL409R	80 x 36 / 90 x 40	6 7/8



# Obstetrics/Gynecology

## Vaginal Retractors and Specula



PMSEL578R-PMSEL579R

### JACKSON Vaginal Speculum Lower Blade

Catalog Number	Blade	Blade Size (mm)	Length (in.)
PMSEL578R	SLIGHT-CONCAVE	89 x 38	6 7/8
PMSEL579R	SLIGHT-CONCAVE	102 x 38	6 7/8



PMSEL578R



PMSEL579R



PMSEL581R, PMSMB764R-PMSMB765R

### EASTMAN Vaginal Retractor

Catalog Number	Blade Size (mm)	Length (in.)
PMSMB764R	75 x 40	6 7/8
PMSEL581R	89 x 38	6 7/8
PMSMB765R	100 x 40	6 7/8

# Obstetrics/Gynecology

## Vaginal Retractors and Specula



### HEANEY Retractor

Catalog Number	Blade Size (mm)	Length (in.)
PMSMB762R	45 x 25	6 3/4
PMSMB763R	73 x 29	6 3/4
PMSEL865R	83 x 29	6 3/4



PMSEL865R



PMSMB762R-PMSMB763R

### DOYEN Vaginal Speculum

Catalog Number	Blade Size (mm)	Length (in.)
PMSEL627R	60 x 45	9 1/4
PMSEL628R	90 x 45	9 1/4
PMSEL629R	112 x 45	9 1/4



PMSEL627R-PMSEL629R



PMSEL627R



PMSEL628R

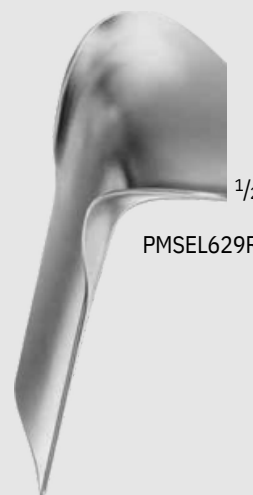

PMSEL629R

INCHES

# Obstetrics/Gynecology

## Vaginal Retractors and Specula

### DOYEN Vaginal Speculum

Catalog Number	Blade Size (mm)	Length (in.)
PMSEL631R	60 x 35	9 1/2
PMSEL632R	90 x 35	9 1/2
PMSEL633R	120 x 35	9 1/2
PMSEL634R	60 x 45	9 1/2
PMSEL635R	90 x 45	9 1/2
PMSEL636R	120 x 45	9 1/2
PMSEL637R	60 x 60	9 1/2
PMSEL638R	90 x 60	9 1/2
PMSEL639R	120 x 60	9 1/2
PMSEL642R	160 x 45	9 1/2
PMSEL644R	160 x 60	9 1/2



PMSEL631R-PMSEL644R

### BREISKY Vaginal Speculum

Catalog Number	Blade Size (mm)	Length (in.)
PMSEL703R	100 x 20	11 3/4
PMSEL704R	100 x 25	11 3/4
PMSEL705R	100 x 30	11 3/4
PMSEL707R	100 x 35	11 3/4
PMSEL708R	100 x 40	11 3/4
PMSEL693R	130 x 20	12 1/2
PMSEL694R	130 x 25	12 1/2
PMSEL695R	130 x 30	12 1/2
PMSEL697R	130 x 35	12 1/2
PMSEL698R	130 x 40	12 1/2
PMSEL700R	160 x 40	13 3/4
PMSEL702R	180 x 40	13 3/4



PMSEL700R-PMSEL708R,  
PMSEL693R-PMSEL698R

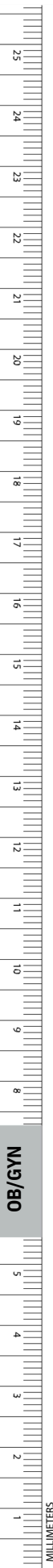

OB/GYN

# Obstetrics/Gynecology

## Vaginal Retractors and Specula

### AUVARD Speculum, W/ Detachable Weight

Catalog Number	Blade Size (mm)	Length (in.)
PMSEL736R	65 x 38-28	9

Weight:  
Speculum, only: 0.3 lbs.  
Weight, only: 1.7 lbs.



PMSEL736R

### AUVARD Speculum, W/ Detachable Weight

Catalog Number	Blade Size (mm)	Length (in.)
PMSEL738R	75 x 42-40	9
PMSEL739R	105 x 43-40	9

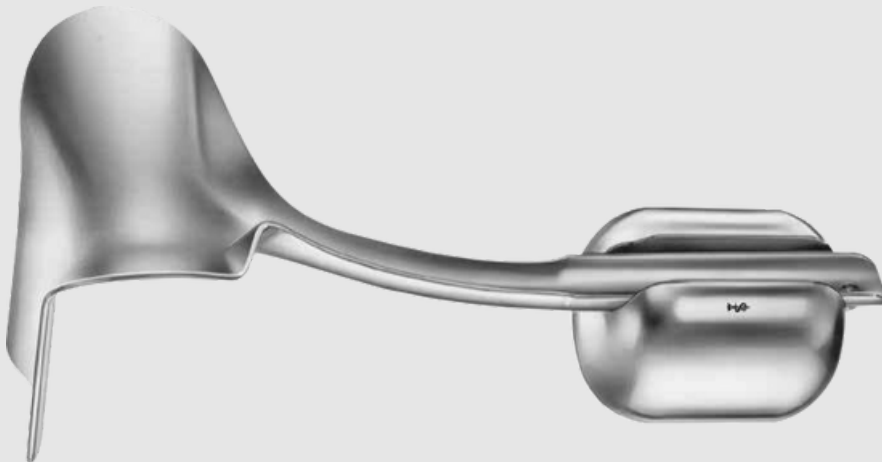

PMSEL738R-PMSEL739R



# Obstetrics/Gynecology

## Vaginal Retractors and Specula

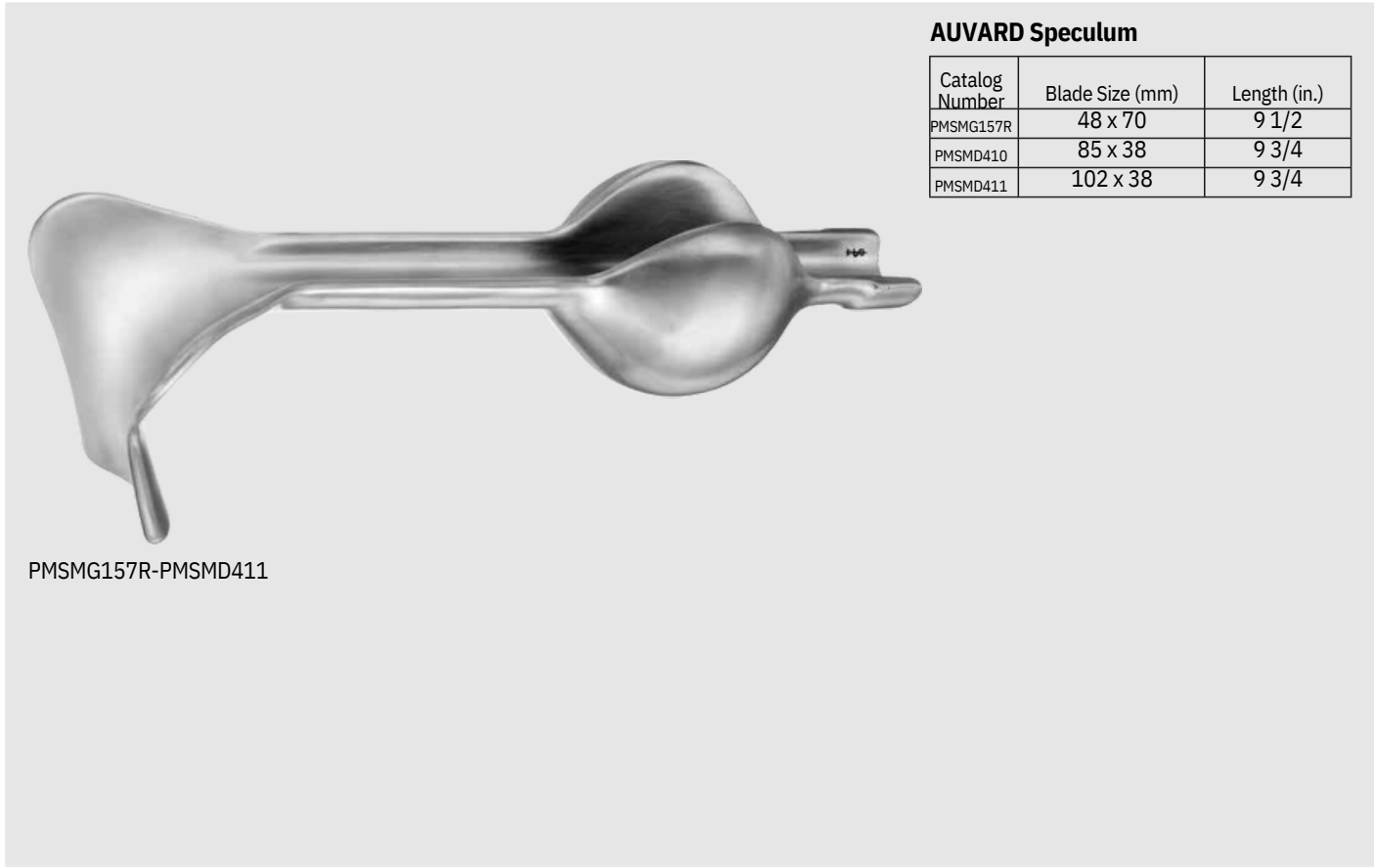

### AUVARD Speculum

Catalog Number	Blade Size (mm)	Length (in.)
PMSG157R	48 x 70	9 1/2
PMSMD410	85 x 38	9 3/4
PMSMD411	102 x 38	9 3/4

PMSG157R-PMSMD411

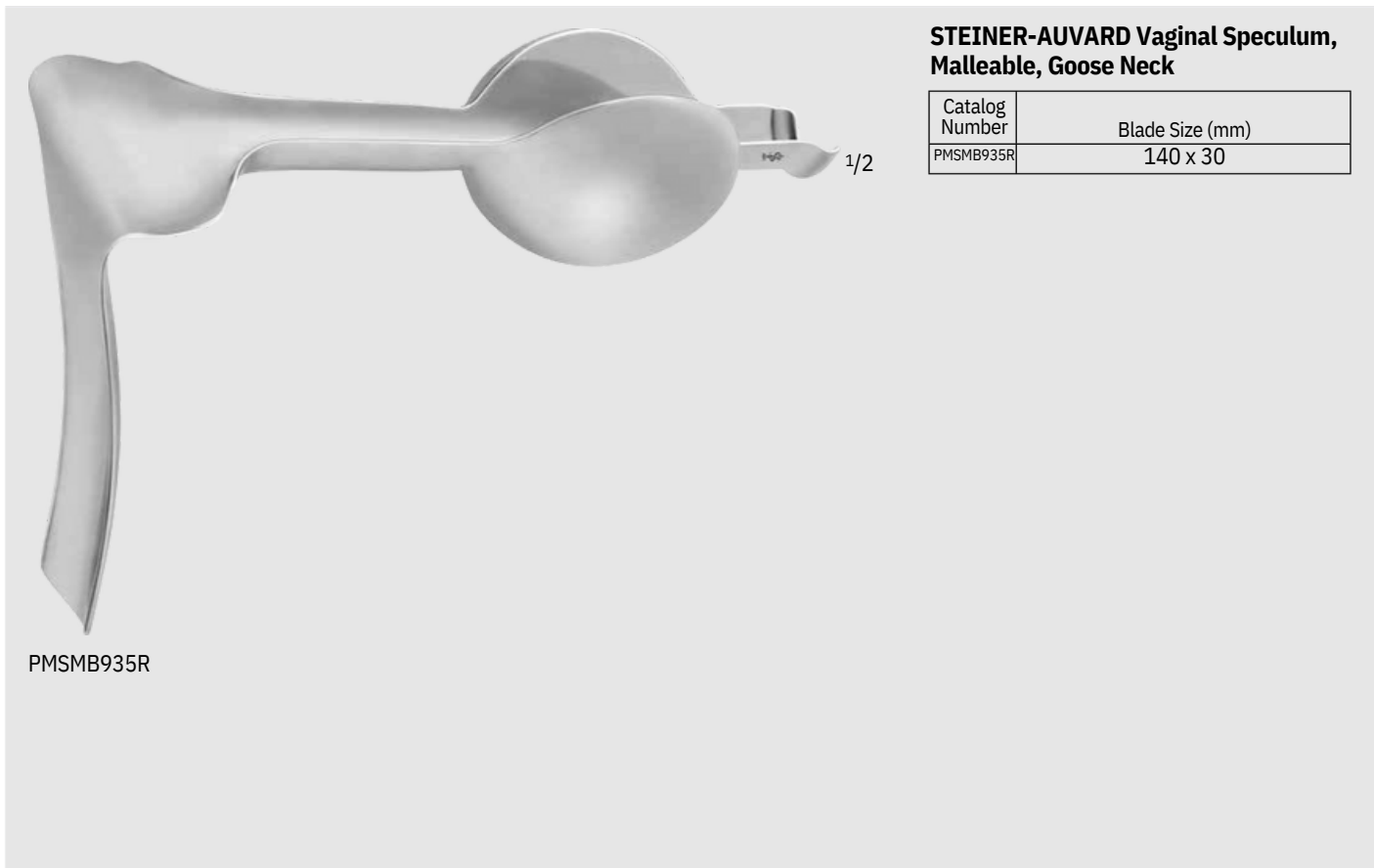

### STEINER-AUVARD Vaginal Speculum, Malleable, Goose Neck

Catalog Number	Blade Size (mm)
PMSMB935R	140 x 30

PMSMB935R

# Obstetrics/Gynecology

## Vaginal Retractors and Specula



### DOYEN Lateral Speculum

Catalog Number	Blade Size (mm)	Length (in.)
PMSEL859R	60 x 30	9
PMSEL860R	80 x 30	9 3/4

PMSEL859R-PMSEL860R



### SCHERBACK Vaginal Speculum Set

Catalog Number	Description	Blade Size (mm)
PMSEL740R	SET COMPLETE	-
PMSEL741R	BLADE	80 x 30
PMSEL742R	BLADE	85 x 35
PMSEL743R	BLADE	85 x 40
PMSEL744R	BLADE	55 x 40
PMSEL745R	BLADE	70 x 45
PMSEL746R	HANDLE	-
PMSEL747R	WEIGHT	-

PMSEL740R-PMSEL747R

EL740R Includes:  
 1 Handle EL746R  
 1 Weight EL747R  
 4 Blades of each  
 EL741R-EL744R



PMSEL741R



PMSEL742R



PMSEL743R

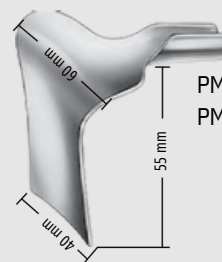

PMSEL744R-  
PMSEL745R



OB/GYN

INCHES

# Obstetrics/Gynecology

## Vaginal Retractors and Specula

### TUEBINGER Vaginal Retractor

Catalog Number	Blade Size (mm)	Length (in.)
PMSEL868R	95 x 20	10 1/2

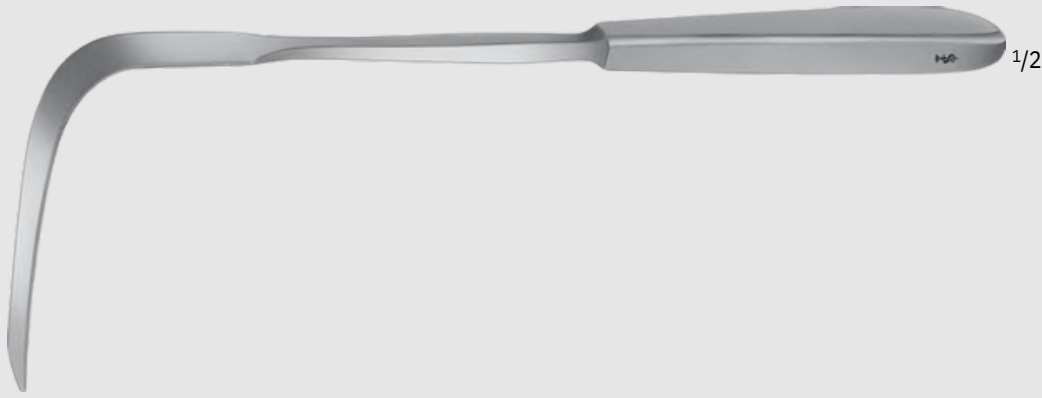

PMSEL868R

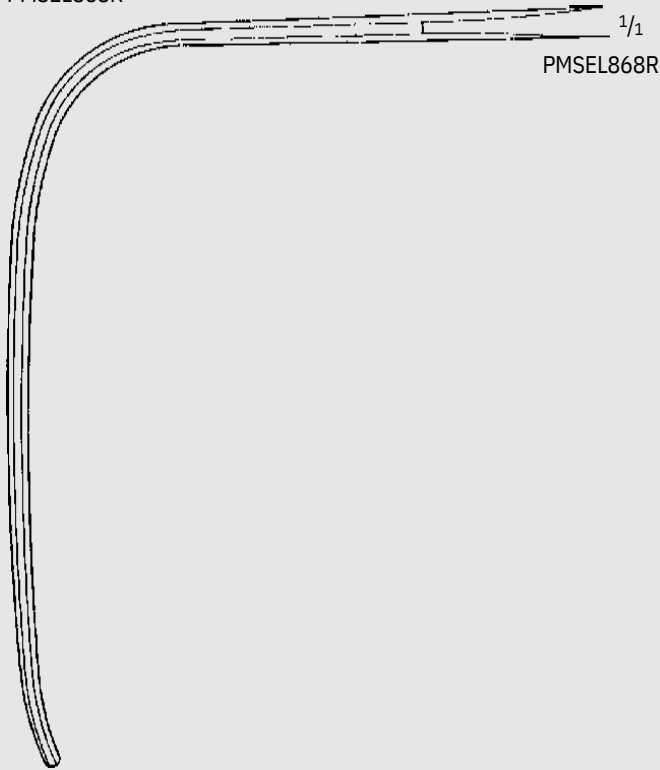

OB/GYN



**Obstetrics/Gynecology**  
Vaginal Retractors and Specula

**GLENNER Retractor**

Catalog Number	Blade Size (mm)	Length (in.)
PMSMG175R	135 x 25	10 5/8



PMSMG175R



# Obstetrics/Gynecology

## Vaginal Retractors and Specula

### MARTIN Vaginal Retractor

Catalog Number	Blade Size (mm)	Length (in.)
PMSEL870R	105 x 27	9 3/4

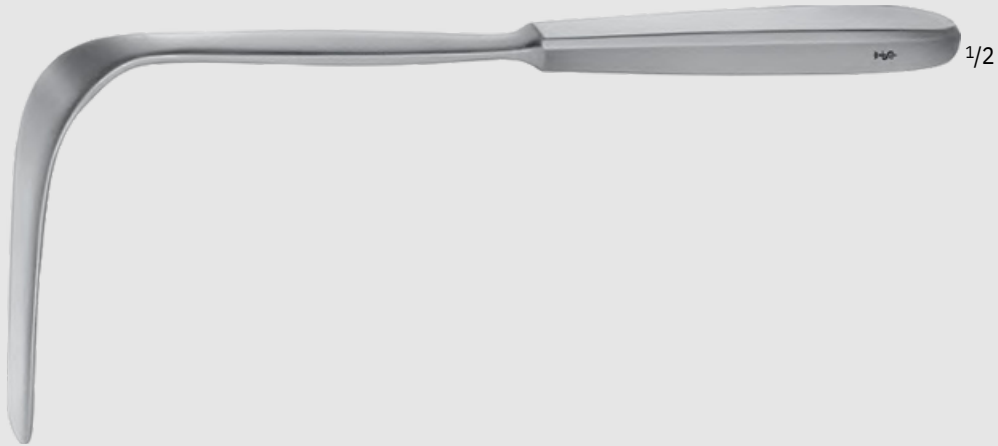

PMSEL870R

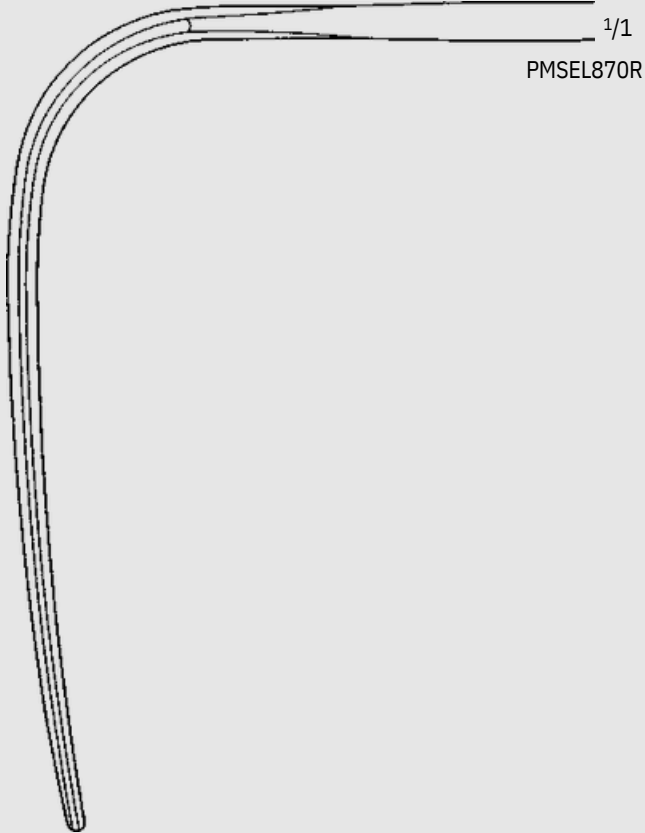

1/1

PMSEL870R

OB/GYN

MILLIMETERS

# Obstetrics/Gynecology

## Vaginal Retractors and Specula

### SIMON Vaginal Retractor

Catalog Number	Blade Size (mm)	Length (in.)
PMSEL872R	115 x 22	10 3/4
PMSEL873R	115 x 27	10 3/4



PMSEL872R-PMSEL872R

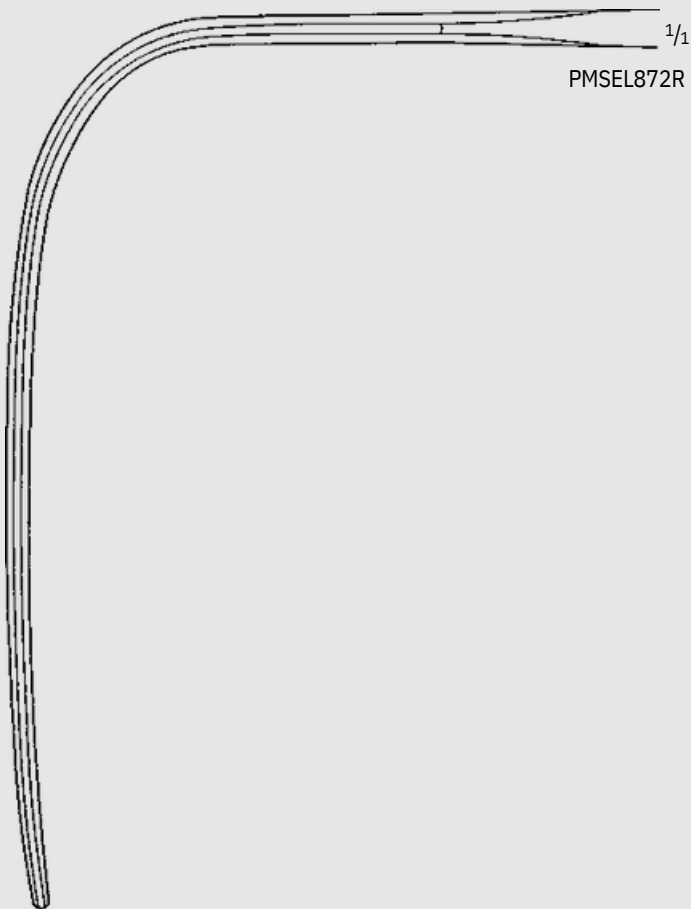

PMSEL872R

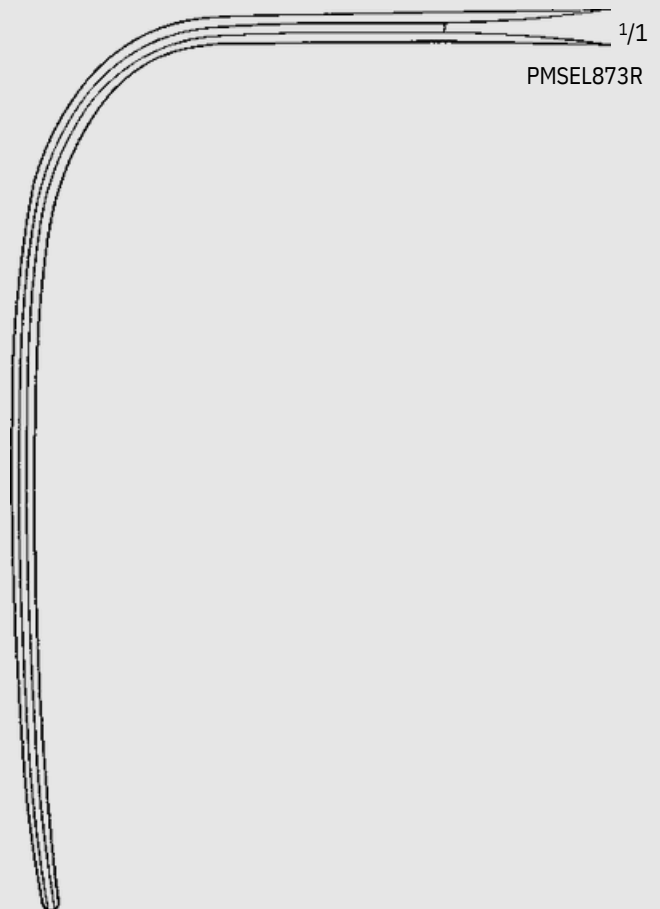

PMSEL873R



# Obstetrics/Gynecology

## Endospecula

### KOGAN Endospeculum

Catalog Number	Length (in.)
PMSEM710R	9 1/2

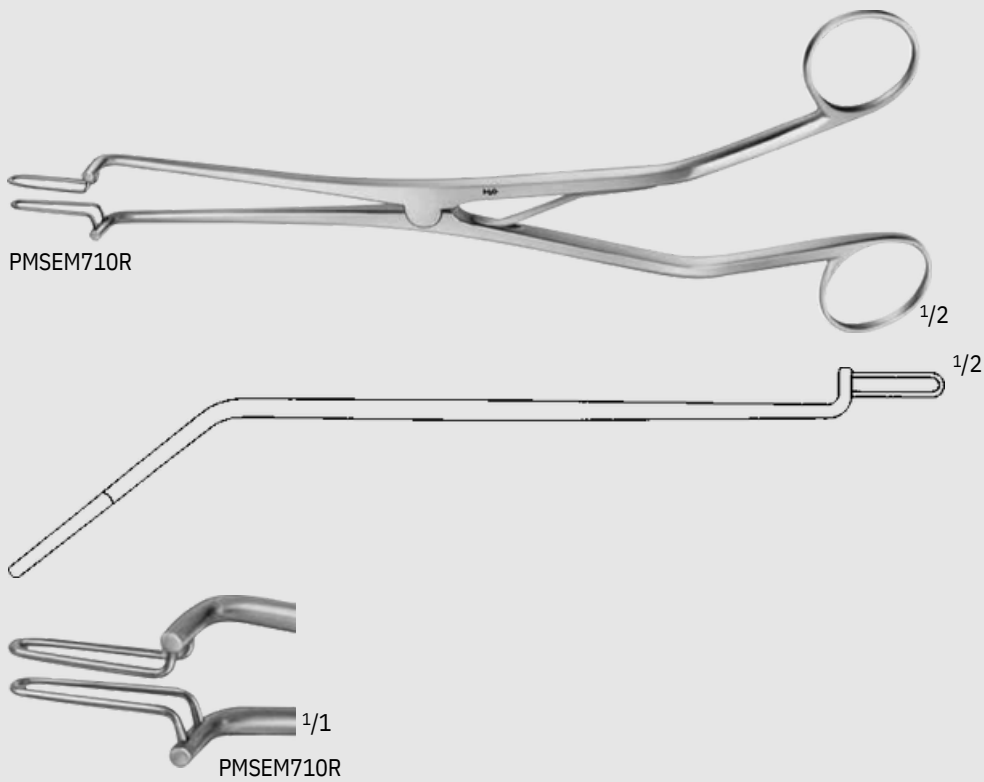

### KOGAN Cervix/Urethra Endospeculum, W/ Scale, Ratcheted

Catalog Number	Length (in.)
PMSEM711R	9 1/2

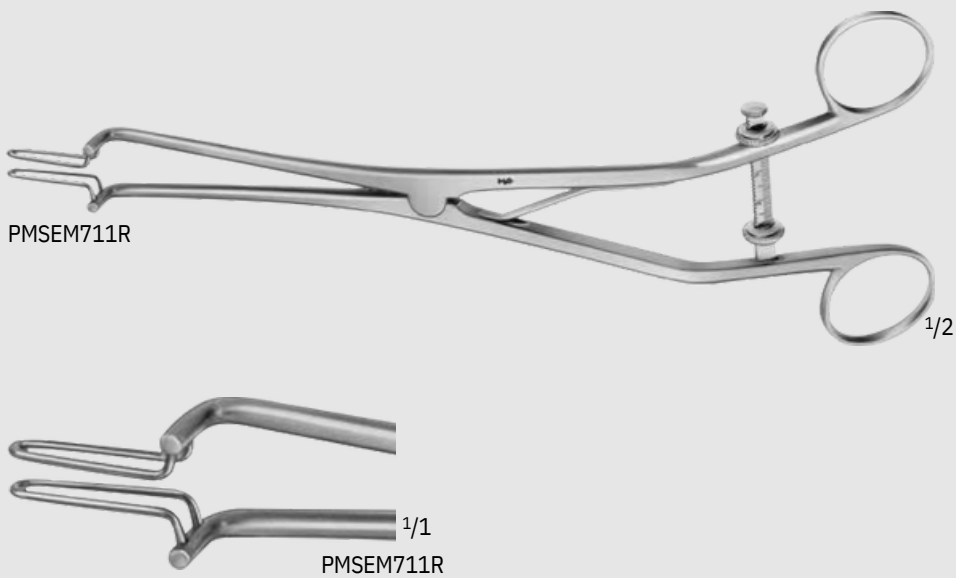

OB/GYN

MILLIMETERS



PMSEM101R-PMSEM147R

**HEGAR Dilator, Single Ended**

Catalog Number	Tip Size (mm)	Length (in.)
PMSEM101R	1	7 1/4
PMSEM102R	2	7 1/4
PMSEM103R	3	7 1/4
PMSEM104R	4	7 1/4
PMSEM105R	5	7 1/4
PMSEM106R	6	7 1/4
PMSEM107R	7	7 1/4
PMSEM108R	8	7 1/4
PMSEM109R	9	7 1/4
PMSEM110R	10	7 1/4
PMSEM111R	11	7 1/4
PMSEM112R	12	7 1/4
PMSEM113R	13	7 1/4
PMSEM114R	14	7 1/4
PMSEM115R	15	7 1/4
PMSEM116R	16	7 1/4
PMSEM117R	17	7 1/4
PMSEM118R	18	7 1/4
PMSEM119R	19	7 1/4
PMSEM120R	20	7 1/4
PMSEM121R	21	7 1/4
PMSEM122R	22	7 1/4
PMSEM123R	23	7 1/4
PMSEM124R	24	7 1/4
PMSEM125R	25	7 1/4
PMSEM126R	26	7 1/4
PMSEM131R	1.5	7 1/4
PMSEM132R	2.5	7 1/4
PMSEM133R	3.5	7 1/4
PMSEM134R	4.5	7 1/4
PMSEM135R	5.5	7 1/4
PMSEM136R	6.5	7 1/4
PMSEM137R	7.5	7 1/4
PMSEM138R	8.5	7 1/4
PMSEM139R	9.5	7 1/4
PMSEM140R	10.5	7 1/4
PMSEM141R	11.5	7 1/4
PMSEM142R	12.5	7 1/4
PMSEM143R	13.5	7 1/4
PMSEM144R	14.5	7 1/4
PMSEM145R	15.5	7 1/4
PMSEM146R	16.5	7 1/4
PMSEM147R	17.5	7 1/4

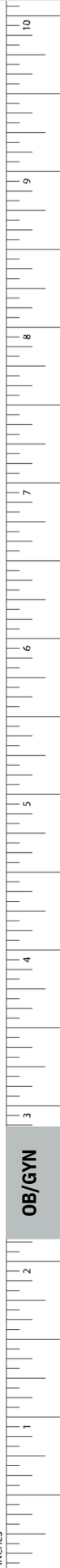

OB/GYN

# Obstetrics/Gynecology

## Dilators and Probes



PMSEM193R-  
PMSEM194R

### HEGAR Dilator Set, Single Ended

Catalog Number	Item
EM193R	SET W/ 14 DILATORS, 4-17 mm
EM194R	SET W/ 26 DILATORS, 1-26 mm

PMSEM193R Includes:  
 PMSEM097R Rack for Dilators 4-12 mm  
 PMSEM098R Rack for Dilators 13-17 mm  
 PMSJG161R Metal Case: 200 x 100 x 35 mm

Includes Dilators:  
 PMSEM104R-PMSEM117R

PMSEM194R Includes:  
 PMSEM099R Rack for Dilators 1-17 mm  
 PMSEM100R Rack for Dilators 18-26 mm  
 PMSJG170R Metal Case: 330 x 220 x 80 mm

Includes Dilators:  
 PMSEM101R-PMSEM126R



PMSEM231R-PMSEM244R

### HEGAR Uterine Dilator, Double Ended

Catalog Number	Tip Size (mm)	Length (in.)
PMSEM244R	SET OF 8	-
PMSEM231R	1/2	7 3/4
PMSEM232R	3/4	7 3/4
PMSEM233R	5/6	7 3/4
PMSEM234R	7/8	7 3/4
PMSEM235R	9/10	7 3/4
PMSEM236R	11/12	7 3/4
PMSEM237R	13/14	7 3/4
PMSEM238R	15/16	7 3/4
PMSEM239R	17/18	7 3/4

Set Includes:  
 PMSEM232R-PMSEM239R

OB/GYN

**HEGAR Uterine Dilator, Slight Curved, Double Ended**

Catalog Number	Tip Size (mm)	Length (in.)
PMSMG270R	SET OF 8	-
PMSMG251R	1/2	8
PMSMG252R	3/4	8
PMSMG253R	5/6	8
PMSMG254R	7/8	8
PMSMG255R	9/10	8
PMSMG256R	11/12	8
PMSMG257R	13/14	8
PMSMG258R	15/16	8
PMSMG259R	17/18	8

PMSMG270R Set of 8 includes PMSMG252R-PMSMG259R



PMSMG270R-PMSMG259R

**PRATT Uterine Dilator**

Catalog Number	Tip Size (FR)	Length (in.)
PMSEM270R	COMPLETE SET	-
PMSEM271R	13/15	11 1/2
PMSEM272R	17/19	11 1/2
PMSEM273R	21/23	11 1/2
PMSEM274R	25/27	11 1/2
PMSEM275R	29/31	11 1/2
PMSEM276R	33/35	11 1/2
PMSEM277R	37/39	11 1/2
PMSEM278R	41/43	11 1/2

EM270R Set of 8 includes EM271R-EM278R



PMSEM270R-PMSEM278R

**HANK Dilator, French Scale**

Catalog Number	Tip Size (FR)	Length (in.)
PMSMD593R	COMPLETE SET	10
PMSMD579R	9/10	10
PMSMD594	11/12	10
PMSMD595	13/14	10
PMSMD596	15/16	10
PMSMD597	17/18	10
PMSMD598	19/20	10

PMSMD593R Set of 6 includes PMSMD579R, PMSMD594-PMSMD598



PMSMD593R-PMSMD598



# Obstetrics/Gynecology

## Dilators and Probes

### HANK Dilator, American Scale

Catalog Number	Tip Size (mm)	Length (in.)
PMSMD070R	COMPLETE SET	-
PMSMD064R	9/10	10 3/4
PMSMD065R	11/12	10 3/4
PMSMD066R	13/14	10 3/4
PMSMD067R	15/16	10 3/4
PMSMD068R	17/18	10 3/4
PMSMD069R	19/20	10 3/4

PMSMD070R Set of 6 includes MD064R-MD069R



### SIMS Uterine Probe, Graduated (cm)

Catalog Number	Tip	Tip Size (mm)	Blade	Length (in.)
PMSE0010R	RGD	4	CVD	13
PMSE0012R	MALL	4	CVD	13

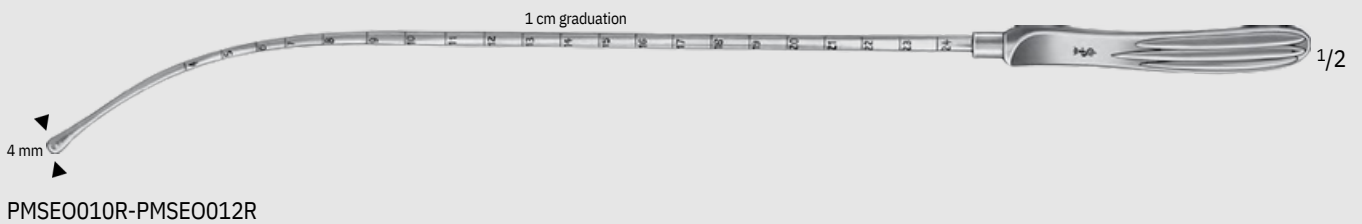

### MARTIN Uterine Probe, Graduated (cm)

Catalog Number	Blade	Length (in.)
PMSE0015R	CVD	11 3/4

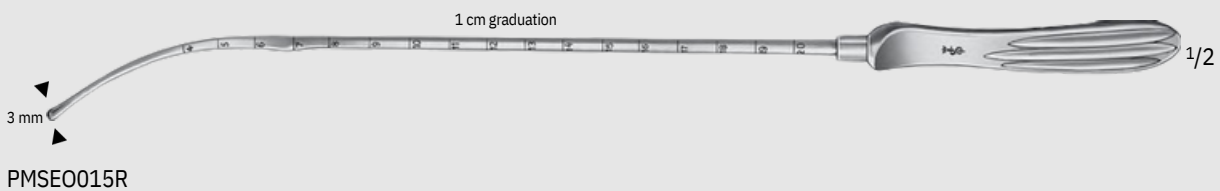

OB/GYN

MILLIMETERS



**VALLEIX Uterine Probe, Graduated (cm), W/ Slider**

Catalog Number	Tip Size (mm)	Blade	Length (in.)
PMSE0016R	4	CVD	9 3/4



**SIMPSON Uterine Probe, Graduated (cm)**

Catalog Number	Tip	Tip Size (mm)	Blade	Length (in.)
PMSE0020	MALL	4	CVD	12 1/4

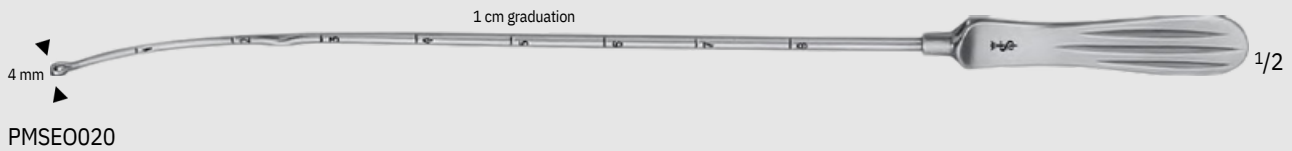

**BRAUN Uterine Depressor, Double Ended**

Catalog Number	Blade Size (mm)	Length (in.)
PMSE0030R	24/28	10 5/8



INCHES

# Obstetrics/Gynecology

## Curettes

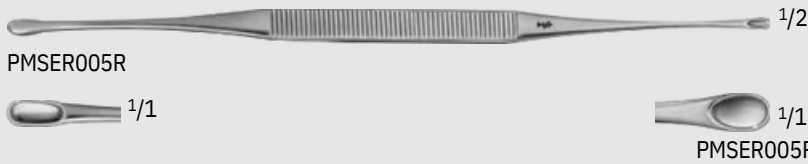

**ASCH Uterine Secretion Scoop, Malleable, Double Ended**

Catalog Number	Length (in.)
PMSER005R	7 7/8

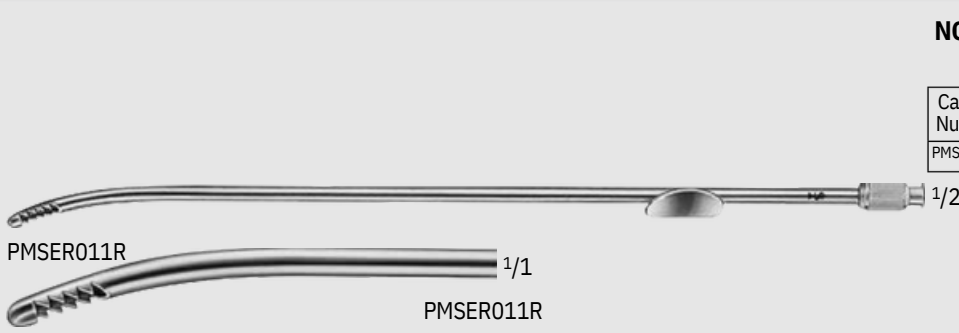

**NOVAK Endometrial Biopsy Suction Curette**

Catalog Number	Length (in.)
PMSER011R	9 1/2

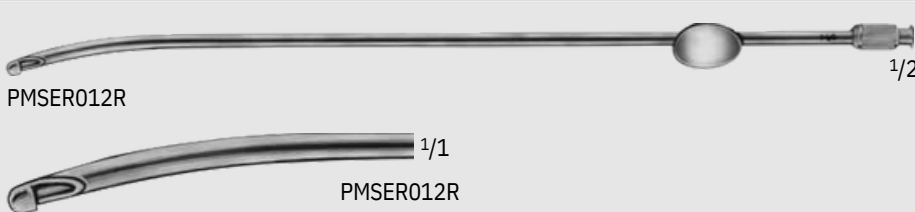

**RANDALL Endometrial Suction and Biopsy Curette**

Catalog Number	Length (in.)
PMSER012R	9 1/2

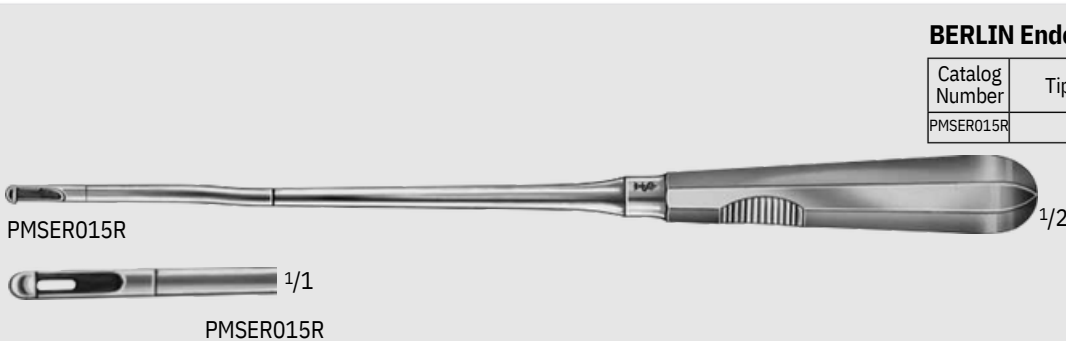

**BERLIN Endometrial Biopsy Curette**

Catalog Number	Tip Size (mm)	Length (in.)
PMSER015R	3.5	10 5/8

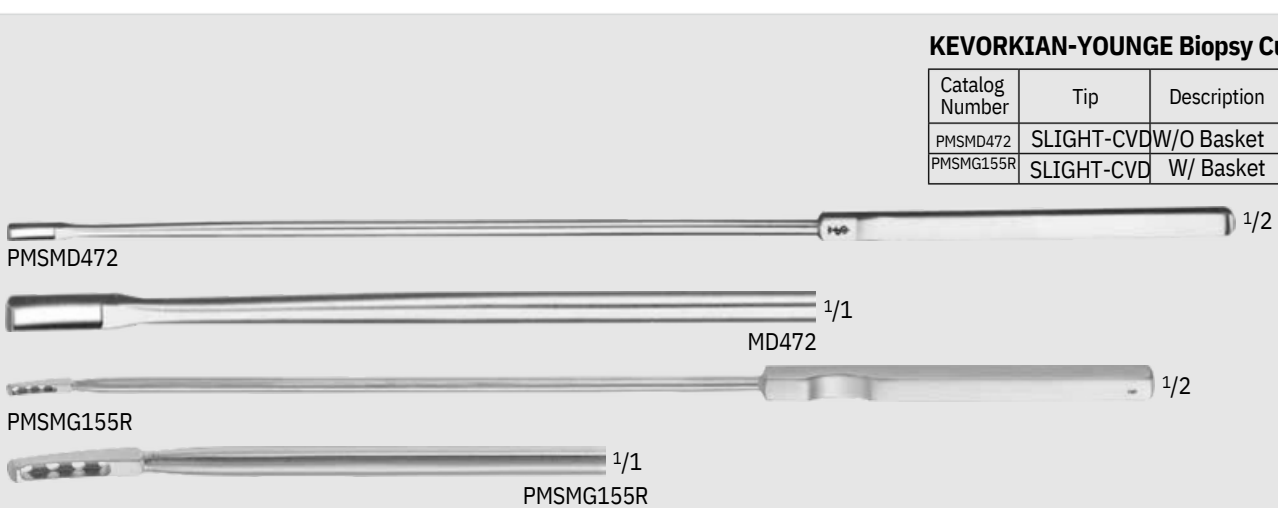

**KEVORKIAN-YOUNGE Biopsy Curette**

Catalog Number	Tip	Description	Length (in.)
PMSMD472	SLIGHT-CVD	W/O Basket	13
PMSMG155R	SLIGHT-CVD	W/ Basket	12 1/4

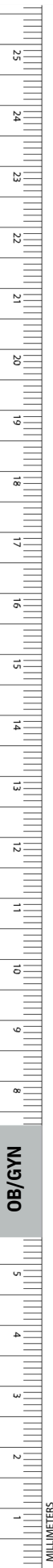

**RECAMIER Uterine Curette**

Catalog Number	Tip Size (#)	Tip Size (mm)	Tip	Length (in.)
PMSE219R	00	4.5	SHARP	11 3/4
PMSE220R	0	7.5	SHARP	11 3/4
PMSE221R	1	8.5	SHARP	11 3/4
PMSE222R	2	10.5	SHARP	11 3/4
PMSE223R	3	12.0	SHARP	11 3/4
PMSE224R	4	14.0	SHARP	11 3/4
PMSE225R	5	15.0	SHARP	11 3/4
PMSE226R	6	16.5	SHARP	11 3/4
PMSE227R	7	18.0	SHARP	11 3/4
PMSE228R	8	19.5	SHARP	11 3/4
PMSE229R	9	21.5	SHARP	11 3/4
PMSE230R	10	23.5	SHARP	11 3/4
PMSE241R	1	8.5	SHARP/MALL	11 3/4
PMSE242R	2	10.5	SHARP/MALL	11 3/4
PMSE243R	3	12.0	SHARP/MALL	11 3/4
PMSE244R	4	14.0	SHARP/MALL	11 3/4
PMSE245R	5	15.0	SHARP/MALL	11 3/4
PMSE246R	6	16.5	SHARP/MALL	11 3/4
PMSE247R	7	18.0	SHARP/MALL	11 3/4
PMSE248R	8	19.5	SHARP/MALL	11 3/4
PMSE320R	0	7.5	BLUNT	11 3/4
PMSE321R	1	8.5	BLUNT	11 3/4
PMSE322R	2	10.5	BLUNT	11 3/4
PMSE323R	3	12.0	BLUNT	11 3/4
PMSE324R	4	14.0	BLUNT	11 3/4
PMSE325R	5	15.0	BLUNT	11 3/4
PMSE326R	6	16.5	BLUNT	11 3/4
PMSE327R	7	18.0	BLUNT	11 3/4
PMSE328R	8	19.5	BLUNT	11 3/4
PMSE329R	9	21.5	BLUNT	11 3/4
PMSE330R	10	23.5	BLUNT	11 3/4
PMSE611R	1	34.5	BLUNT	14 1/4
PMSE612R	2	39.5	BLUNT	14 1/4

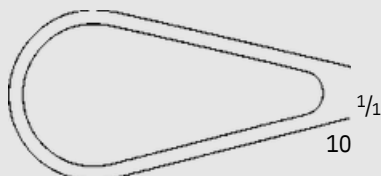
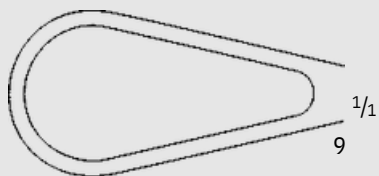
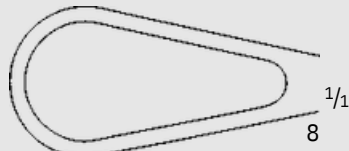
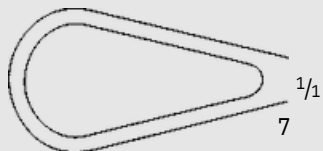
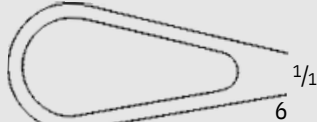
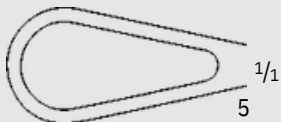
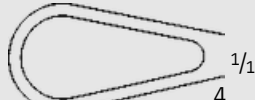
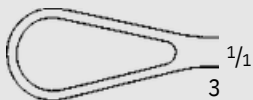
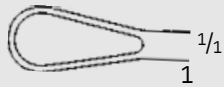
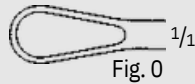
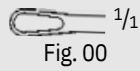
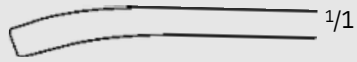

PMSE611R-PMSE612R

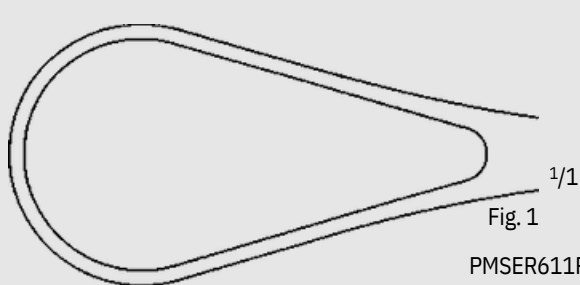

PMSE611R

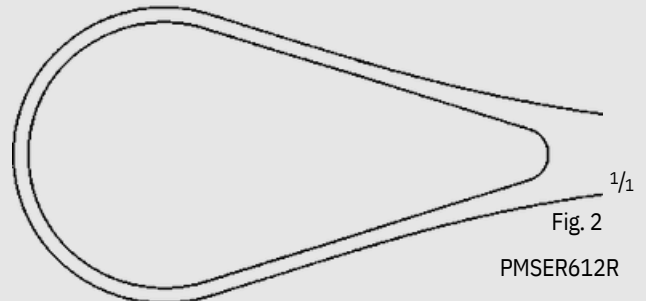

PMSE612R



INCHES

OB/GYN

# Obstetrics/Gynecology

## Curettes

### SIMS Uterine Curette

Catalog Number	Tip Size (#)	Tip Size (mm)	Tip	Length (in.)
PMSER401R	1	7.5	SHARP	10
PMSER402R	2	8.5	SHARP	10
PMSER403R	3	10.5	SHARP	10
PMSER404R	4	12.0	SHARP	10
PMSER405R	5	14.0	SHARP	10
PMSER406R	6	15.0	SHARP	10
PMSER411R	1	7.5	SHARP/MALL	10
PMSER412R	2	8.5	SHARP/MALL	10
PMSER413R	3	10.5	SHARP/MALL	10
PMSER414R	4	12.0	SHARP/MALL	10
PMSER415R	5	14.0	SHARP/MALL	10
PMSER416R	6	15.0	SHARP/MALL	10
PMSER421R	1	7.5	BLUNT	10
PMSER422R	2	8.5	BLUNT	10
PMSER423R	3	10.5	BLUNT	10
PMSER424R	4	12.0	BLUNT	10
PMSER425R	5	14.0	BLUNT	10
PMSER426R	6	15.0	BLUNT	10
PMSMG140R	000	4.5	SHARP/MALL	11
PMSMG141R	00	5.6	SHARP/MALL	11
PMSMG142R	0	6.2	SHARP/MALL	11
PMSMG143R	1	7.3	SHARP/MALL	11
PMSMG144R	2	8.5	SHARP/MALL	11
PMSMG145R	3	9.4	SHARP/MALL	11
PMSMG146R	4	10.6	SHARP/MALL	11
PMSMG147R	5	11.5	SHARP/MALL	11
PMSMG148R	6	12.6	SHARP/MALL	11



PMSER401R-PMSMG148R

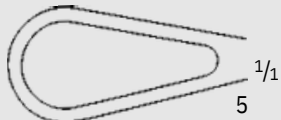
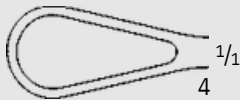

PMSER401R-PMSER426R

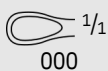

PMSMG140R-PMSMG148R

OB/GYN

**BUMM Uterine Curette, Blunt Malleable**

Catalog Number	Tip Size (#)	Tip Size (mm)	Length (in.)
PMSE520R	0	16.0	11 1/2
PMSE521R	1	18.0	11 1/2
PMSE522R	2	19.5	11 1/2
PMSE523R	3	21.5	11 1/2
PMSE524R	4	23.5	11 1/2
PMSE525R	5	26.0	11 1/2
PMSE526R	6	28.5	11 1/2



PMSE520R-PMSE526R

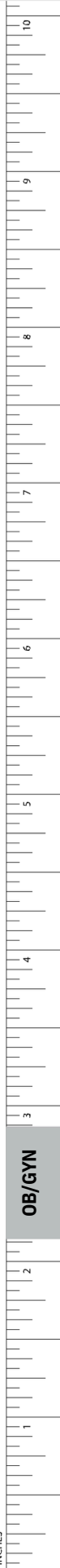
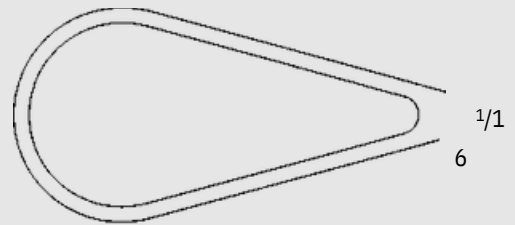
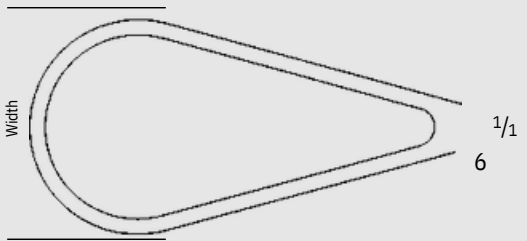
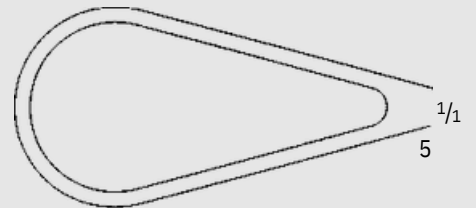
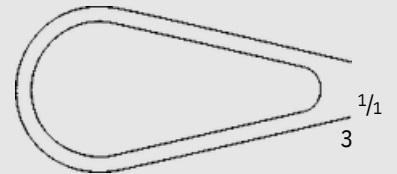
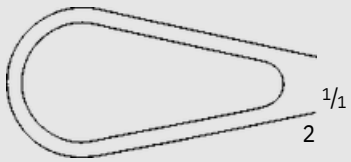
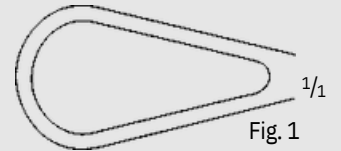
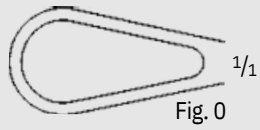

# Obstetrics/Gynecology

## Curettes

### SIMS THOMAS Uterine Curette, Blunt/Malleable

Catalog Number	Tip Size (#)	Tip Size (mm)	Length (in.)
PMSG149R	0	6.0	11
PMSER211R	1	8.5	11
PMSER212R	2	10.5	11
PMSER213R	3	12.0	11
PMSER214R	4	14.0	11
PMSER215R	5	15.0	11
PMSER216R	6	16.5	11



PMSG149R-PMSER216R

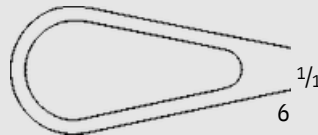
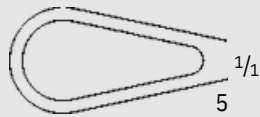
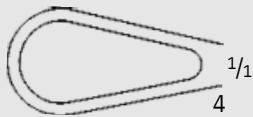
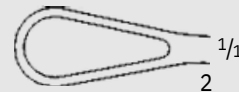
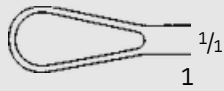

### KELLY-GRAY Uterine Curette

Catalog Number	Tip Size (#)	Tip Size (mm)	Length (in.)
PMSMB375R	1	5.0	9 1/2
PMSMB376R	2	6.0	9 1/2
PMSMB377R	3	7.5	9 1/2
PMSMB378R	4	8.5	9 1/2



PMSMB375R-PMSMB378R



OB/GYN

**HEANEY Uterine Curette, Malleable**

Catalog Number	Tip	Length (in.)
PMSE025R	TOOTHED	9 1/2



PMSE025R



PMSE025R

**COLLIN Uterine Curette, Rigid**

Catalog Number	Tip	Length (in.)
PMSE580R	TOOTHED	11 3/4



PMSE580R



PMSE580R

**BLAKE Uterine Curette, Double Ended**

Catalog Number	Tip	Length (in.)
PMSE585R	SHARP/BLUNT	10 3/4



PMSE585R

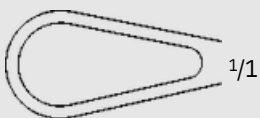

1/1



1/1

PMSE585R

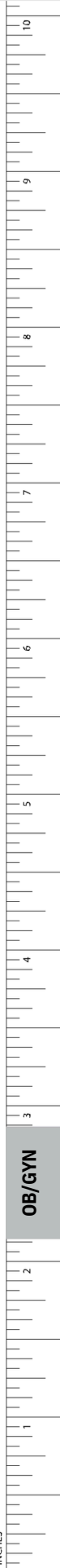

INCHES

OB/GYN

# Obstetrics/Gynecology

## Curettes

### BUMM Uterine Curette

Catalog Number	Tip Size (#)	Tip Size (mm)	Tip	Length (in.)
PMSER621R	1	23.5	SHARP/MALL	12 1/4
PMSER623R	3	28.5	SHARP/MALL	12 1/4
PMSER626R	1	23.5	BLUNT/MALL	12 1/4
PMSER627R	2	26.0	BLUNT/MALL	12 1/4
PMSER628R	3	28.5	BLUNT/MALL	12 1/4



PMSER621R-PMSER628R

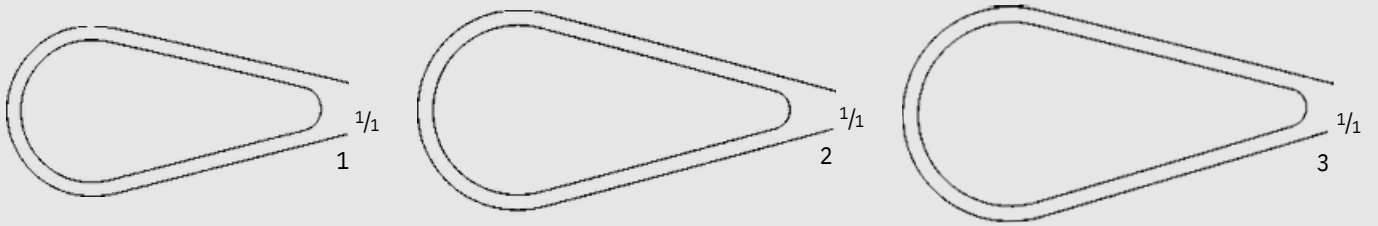

### WALLICH Placenta/Ovum Scoop

Catalog Number	Tip	Length (in.)
PMSER602R	CVD	16 3/4



PMSER602R

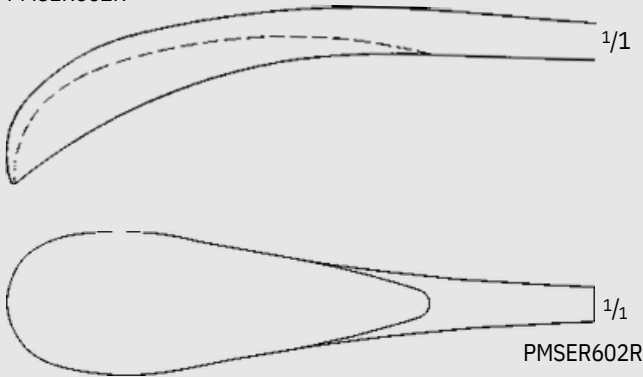

OB/GYN





PMSET096R



PMSSR580R

**Guide Sheath, IOWA Trumpet**

Catalog Number	Tip Size (mm)	Description	Length (in.)
PMSET096R	—	—	6 7/8
PMSSR580R	1 x 185	INJECTION NEEDLE, LUER-LOCK HUB	—

**Uterine Cannula W/ 2 Cones**

Catalog Number	Length (in.)
PMSE876	13 3/4

- Cones:  
 1 PMSER876201 (small)  
 1 PMSER876202 (large)



PMSE876





# **PARKER MEDICAL SUPPLIES**

## **CONTACT US**



**+1 (832) 343-3140**



**info@parkermedicalsupplies.com**



**www.parkermedicalsupplies.com**

## **VISIT US:**

**2800 Post Oak Blvd, Ste 5600, Houston TX 77056, United States**