



PARKER MEDICAL SUPPLIES



PMS UROLOGY SURGICAL INSTRUMENTS

Product Catalog



+1 (832) 343-3140



info@parkermedicalsupplies.com



www.parkermedicalsupplies.com

2800 Post Oak Blvd, Ste 5600, Houston TX 77056, United States





Urology

Needles	1298
Instruments for Radical Prostatectomy	1299 - 1302
Forceps and Clamps	1303 - 1313
Retractors	1314 - 1318
Catheters, Guides and Sounds	1319 - 1322

Urology

Needles



REVERDIN Needle

Catalog Number	Tip	Length (in.)
PMSBM711R	SLIGHT-CVD	7 3/4
PMSBM712R	CVD	7 3/4
PMSBM713R	HEAVY-CVD	7 3/4
PMSBM714R	X-HEAVY-CVD	7 3/4
PMSBM726R	SLIGHT-CVD	9
PMSBM727R	CVD	9
PMSBM728R	HEAVY-CVD	9
PMSBM729R	X-HEAVY-CVD	9

BARRÉ Scalpel Handle #3L, F/ Blade nos. 10-15, 40, 42

Catalog Number	Blade Shape	Blade Angle	Length (in.)
PMSBB176R	ANG	12°	9 3/4



PMSBB176R

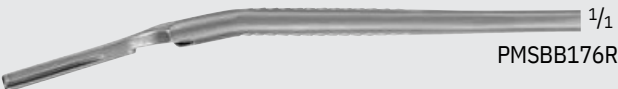

PMSBB176R

BARRÉ Scalpel Handle #3XL, F/ Blade nos. 10-15, 40, 42

Catalog Number	Blade Shape	Length (in.)
PMSBB177R	STR	9 3/4



PMSBB177R



PMSBB177R

BARRÉ Scalpel Handle #3XL, F/ Blade nos. 10-15, 40, 42

Catalog Number	Blade Shape	Blade Angle	Length (in.)
PMSBB178R	ANG	25°	9 3/4



PMSBB178R



PMSBB178R



Urology

BARRÉ Instruments for Radical Prostatectomy

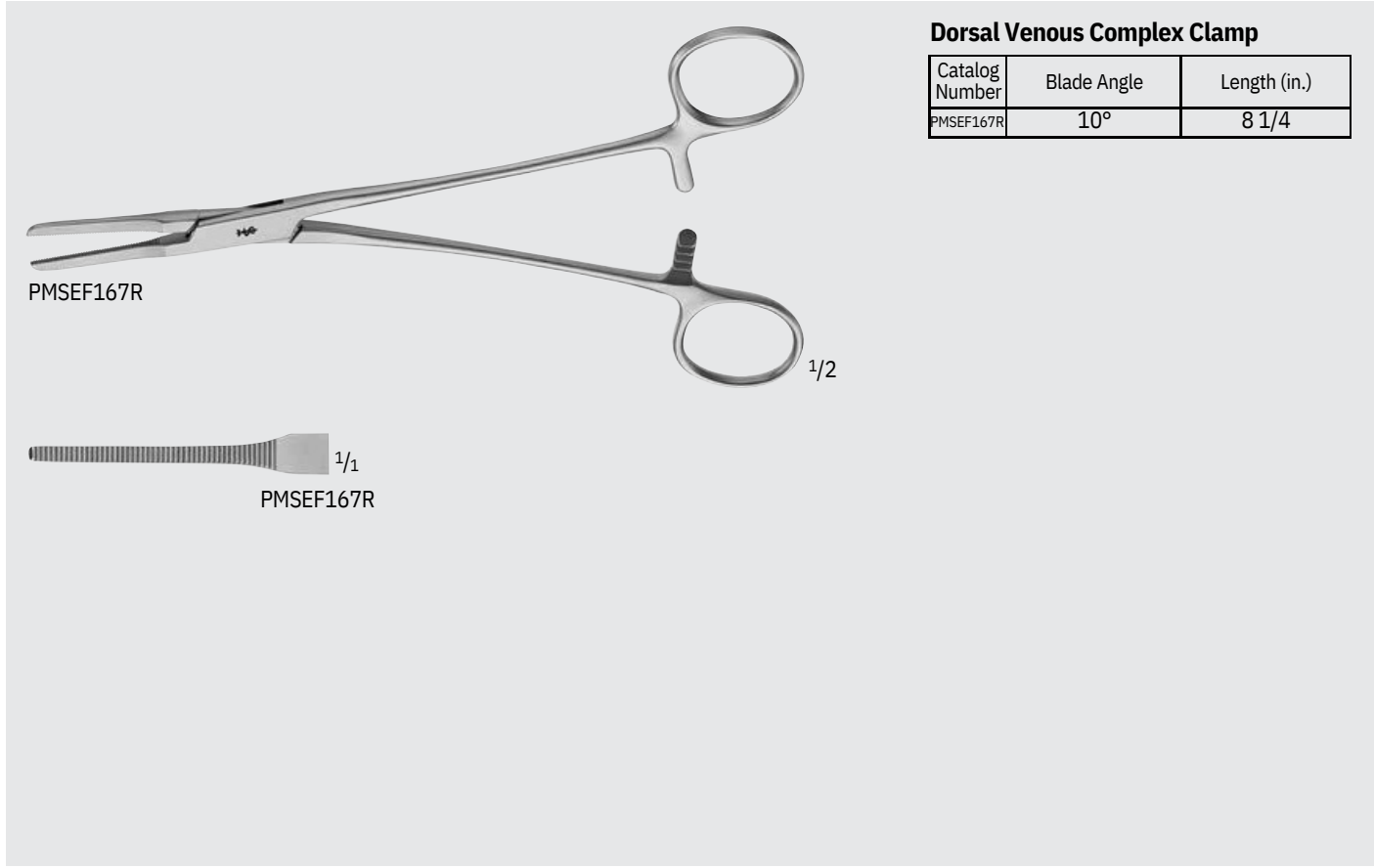

Dorsal Venous Complex Clamp

Catalog Number	Blade Angle	Length (in.)
PMSEF167R	10°	8 1/4

PMSEF167R

1/2

PMSEF167R

1/1

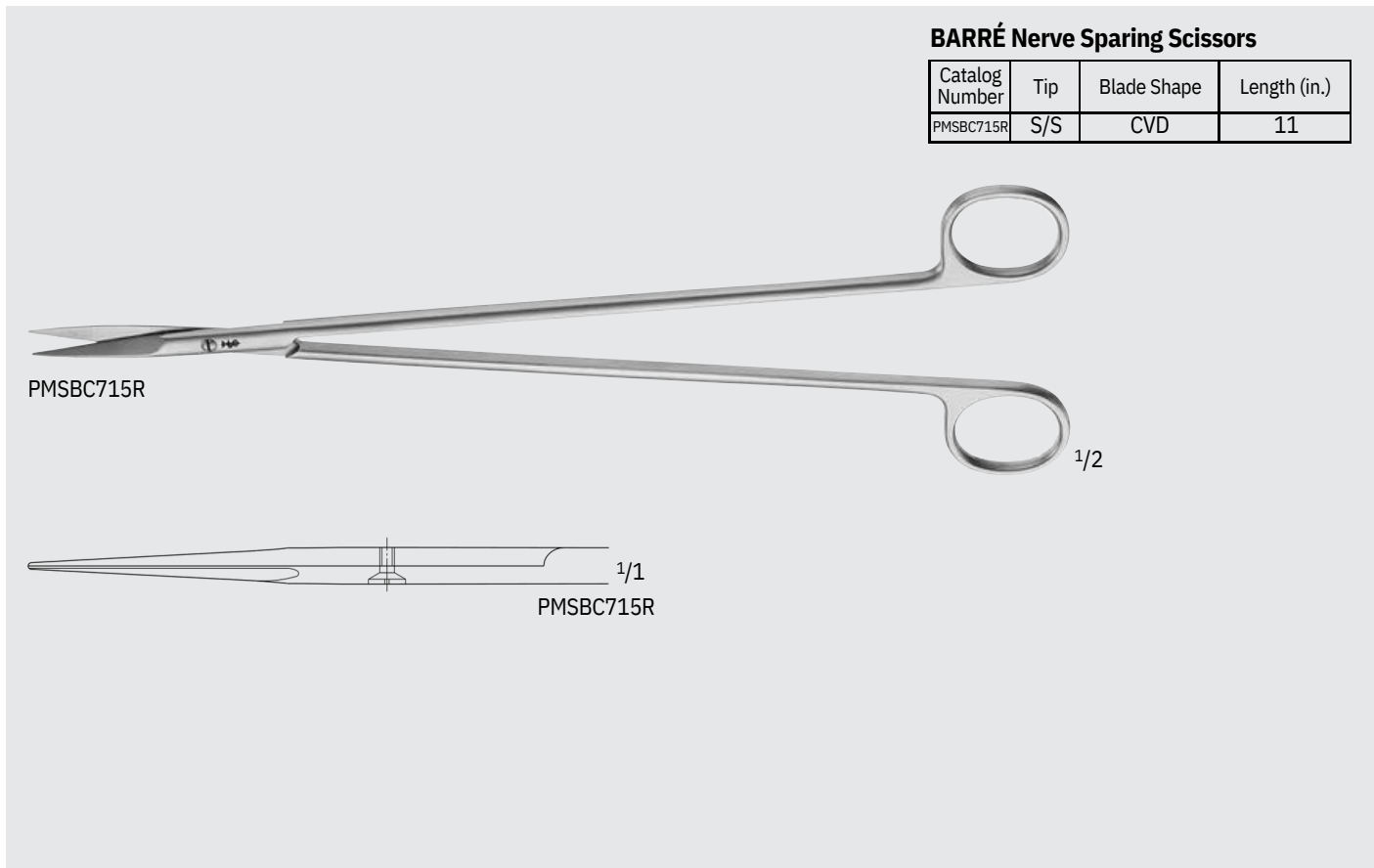

BARRÉ Nerve Sparing Scissors

Catalog Number	Tip	Blade Shape	Length (in.)
PMSBC715R	S/S	CVD	11

PMSBC715R

1/2

PMSBC715R

1/1

BARRÉ Nerve Sparing Dissector

Catalog Number	Tip	Length (in.)
PMSBJ029R	X-FINE	1
PMSBJ110R	FINE	1

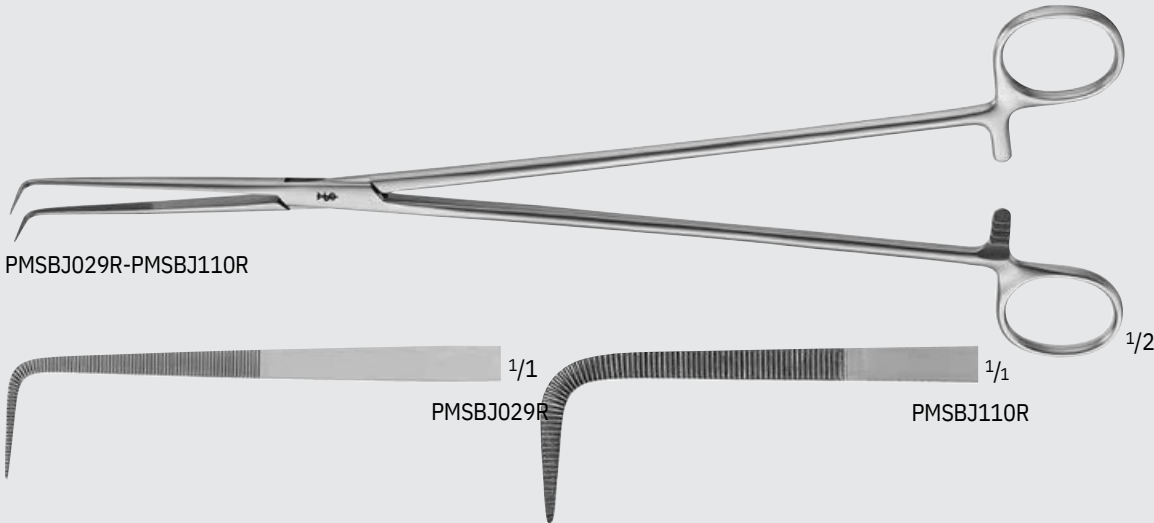

PMSBJ029R-PMSBJ110R

PMSBJ029R

PMSBJ110R

BARRÉ Prostate Retractor

Catalog Number	Length (in.)
PMSBT680R	14 1/4

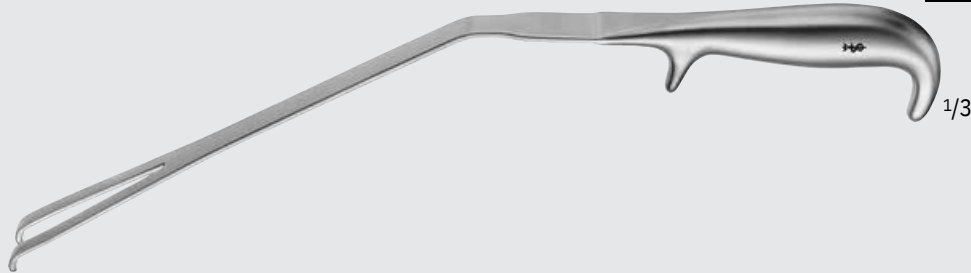

PMSBT680R

BARRÉ Urethra Retractor

Catalog Number	Tip	Length (in.)
PMSBT682R	SMALL	10 1/4
PMSBT683R	LARGE	10 1/4
PMSBT681R	—	15 3/8

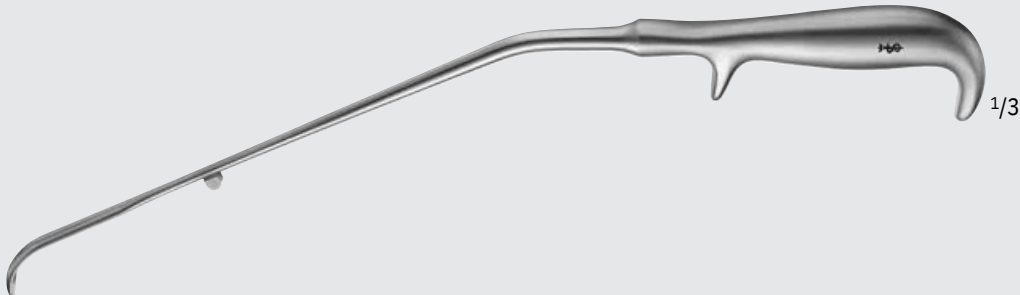

PMSBT681R



Urology

BARRÉ Instruments for Radical Prostatectomy

BARRÉ Suture Holding Frame

Catalog Number	Length (in.)
PMSBV927R	18 1/4

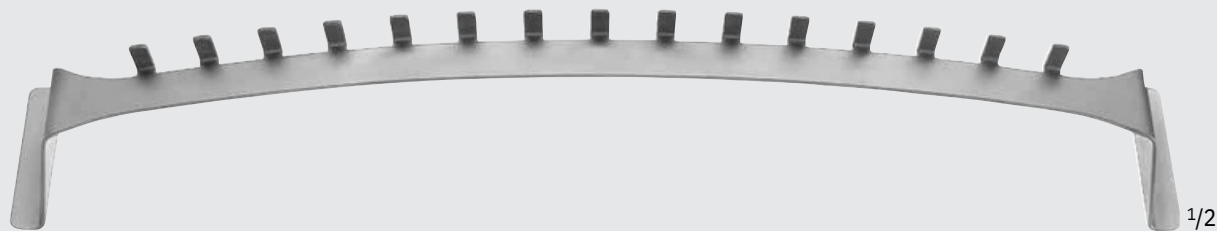

PMSBV927R

BARRÉ Prostatectomy Retractor

Catalog Number	Description	Blade Size, Depth x Width (in.)	Length (in.)
PMSBV921R	COMPLETE RETRACTOR SYSTEM	-	
PMSBV922R	RETRACTOR ONLY	-	
PMSBV840R	MUENSTER OCTANGULAR NOTCH ROD	-	7 7/8
PMSBV849R	MUENSTER UNIVERSAL CONNECTING CLAMP	-	2 3/8
PMSBV925R	BARRÉ COLD LIGHT SUPPORT	-	
PMSBV924R	BARRÉ RETRACTOR BLADES PAIR OF BLADES 2" DEPTH x 2 1/4" WIDTH	2 x 2 3/4	
PMSBV926R	LATERAL BLADE MALLEABLE 2" DEPTH x 7 1/2" WIDTH	2 x 7 1/2	7 1/2
PMSBV929R	CENTER BLADE 2 1/4" DEPTH x 2 3/4" WIDTH	2 1/4 x 2 3/4	9 1/4

PMSBV921R Full Set includes:

- PMSBV922R
- PMSBV840R
- PMSBV849R
- PMSBV925R
- PMSBV924R
- PMSBV926R
- PMSBV929R



PMSBV921



PMSBV922



PMSBV840



PMSBV849



PMSBV925



PMSBV924



PMSBV926

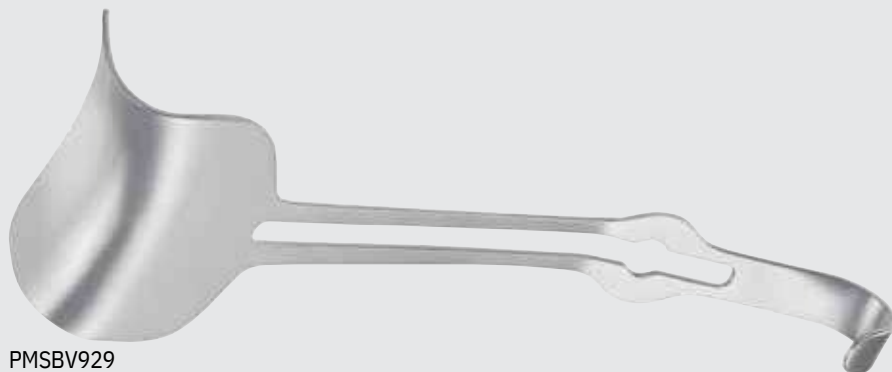

PMSBV929

UROLOGY

GUYON Atraumatic Kidney Clamp

Catalog Number	Length (in.)
PMSEF002R	9
PMSEF001R	9 1/2



PMSEF002R-PMSEF001R

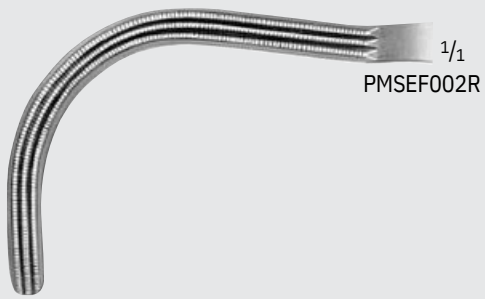

1/1
 PMSEF002R

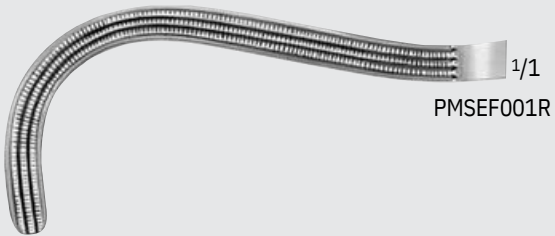

1/1
 PMSEF001R

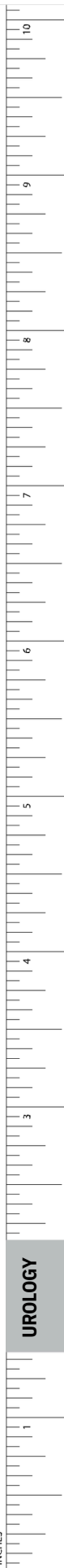

INCHES

Urology

Forceps and Clamps

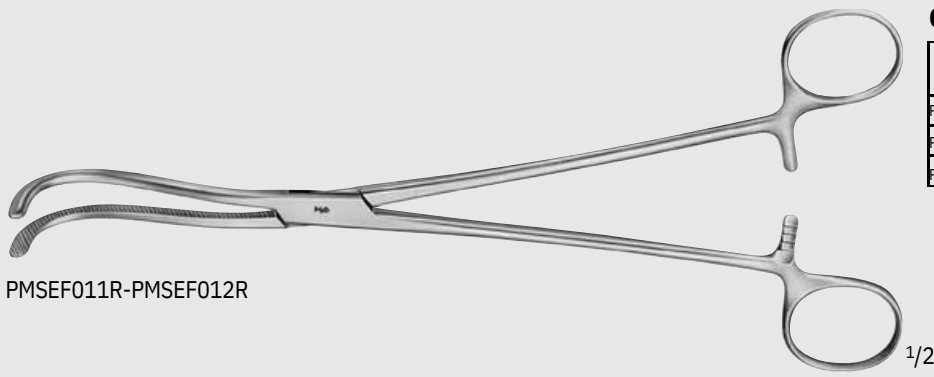

GUYON Kidney Clamp

Catalog Number	Length (in.)
PMSEF011R	9
PMSEF010R	9 1/4
PMSEF012R	11

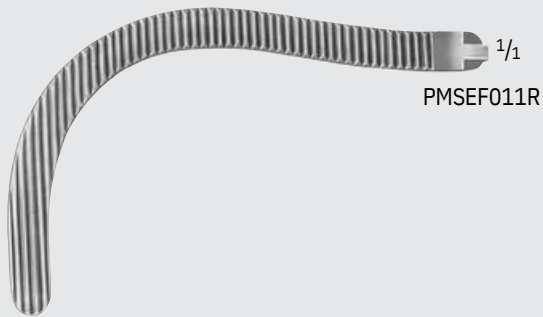

PMSEF011R

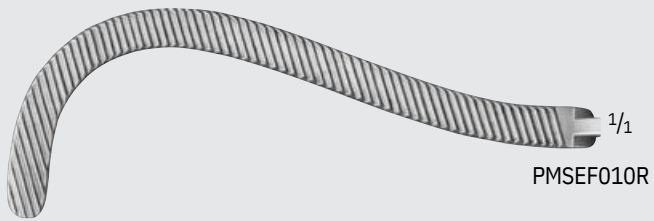

PMSEF010R

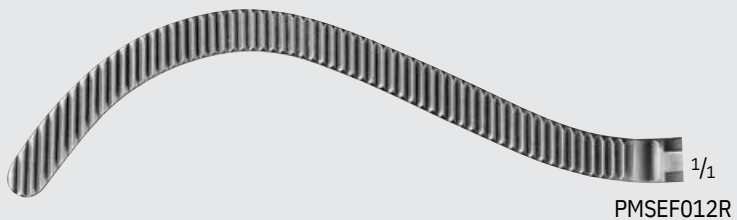

PMSEF012R

UROLOGY

STILLE Kidney Clamp

Catalog Number	Length (in.)
PMSEF016R	8 7/8
PMSEF015R	9 1/2

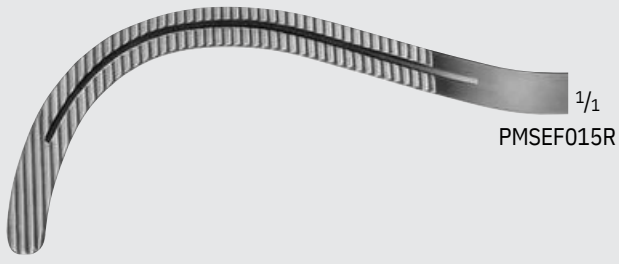
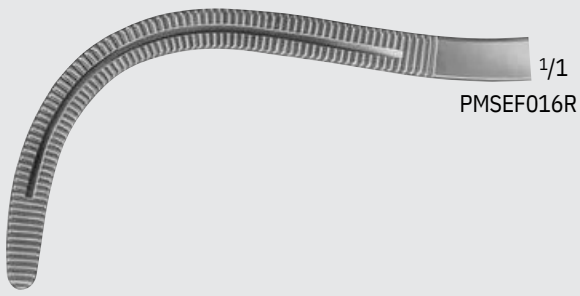
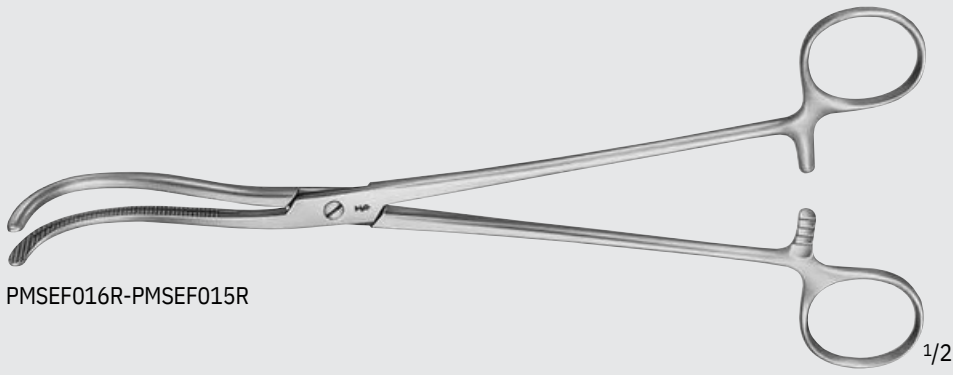

Urology

Forceps and Clamps

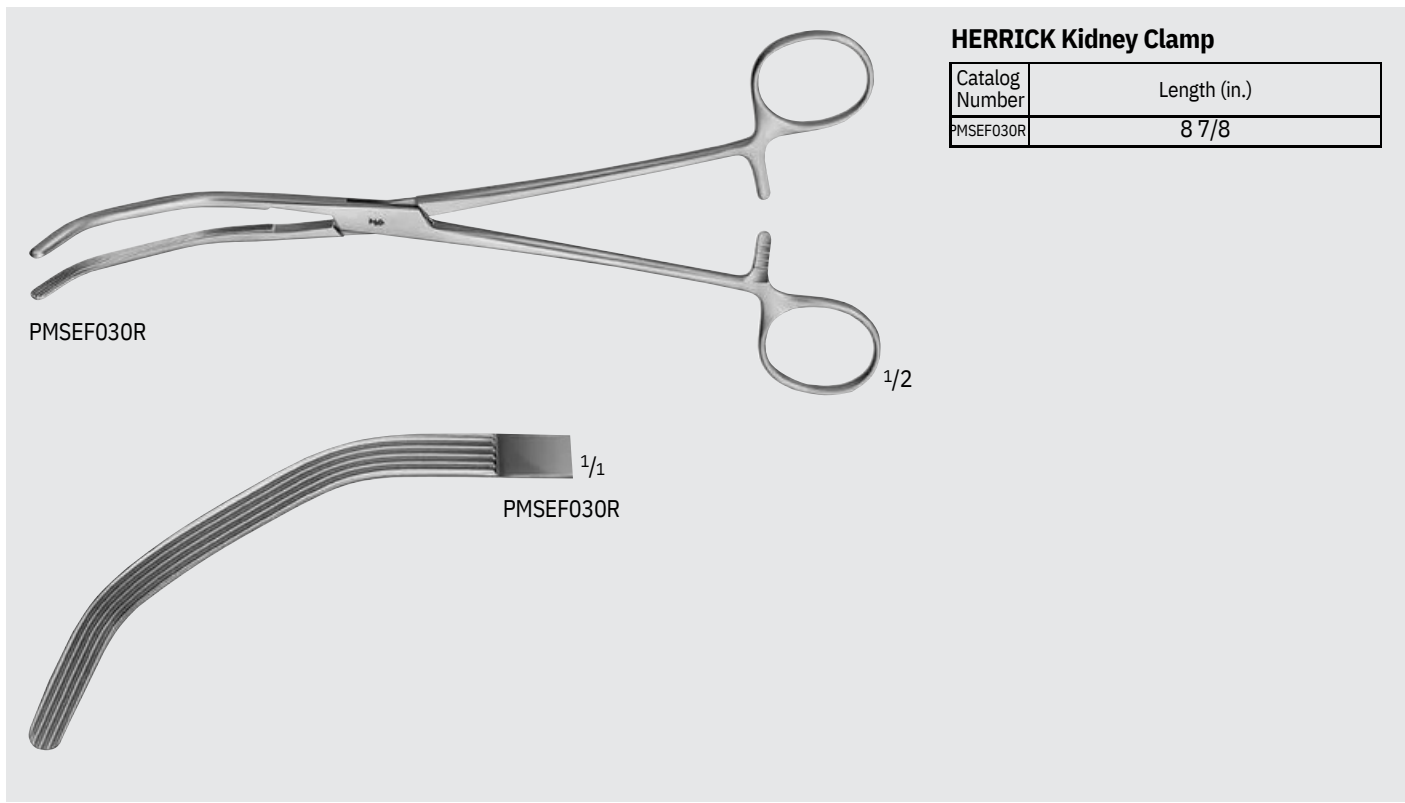

HERRICK Kidney Clamp

Catalog Number	Length (in.)
PMSEF030R	8 7/8

PMSEF030R

1/2

1/1
PMSEF030R

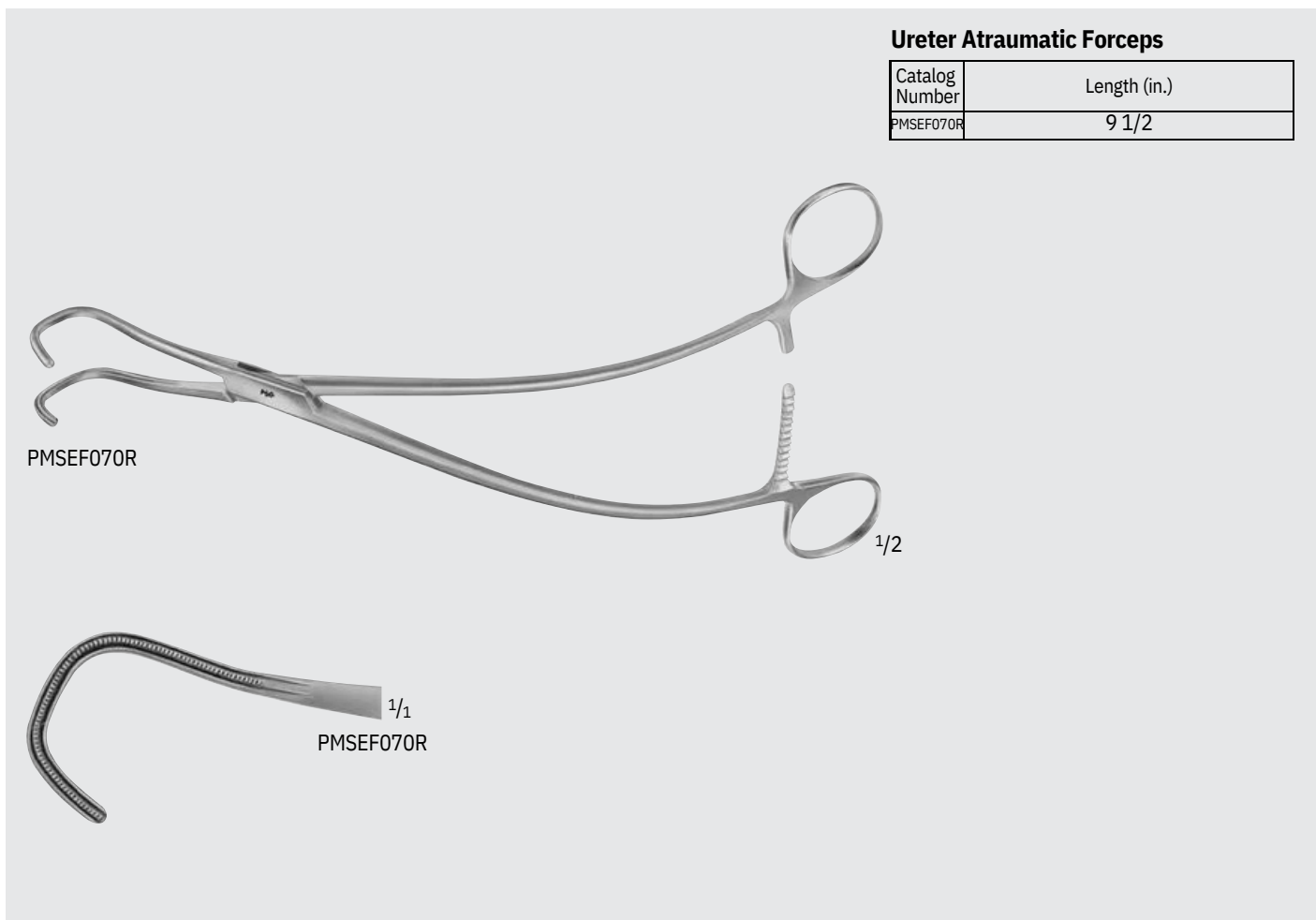

Ureter Atraumatic Forceps

Catalog Number	Length (in.)
PMSEF070R	9 1/2

PMSEF070R

1/2

1/1
PMSEF070R

UROLOGY

MILLIMETERS

HEIMING Kidney Stone Forceps

Catalog Number	Jaw	Length (in.)
PMSEF047R	SLIGHT-CVD	6 3/4
PMSEF048R	HEAVY-CVD	6 1/4



Urology

Forceps and Clamps

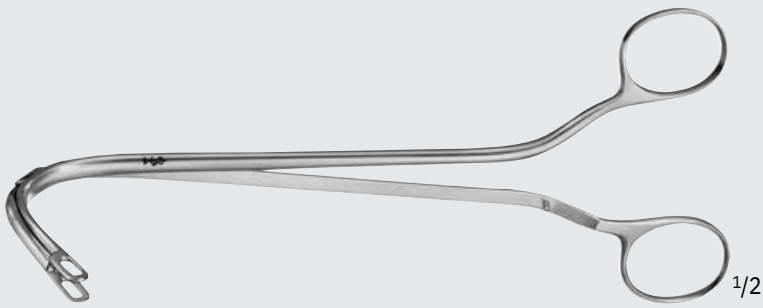

PMSEF055R-PMSEF056R

RANDALL Kidney Stone Forceps

Catalog Number	Jaw	Length (in.)
PMSEF055R	CVD	7 1/2
PMSEF056R	HEAVY-CVD	7 1/2

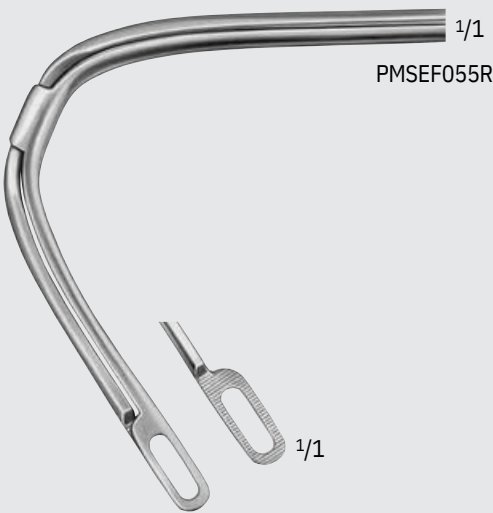

PMSEF055R

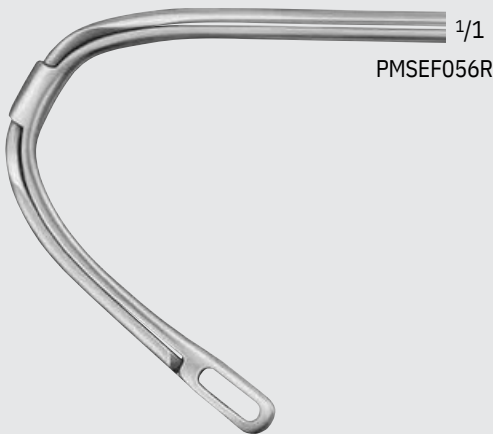

PMSEF056R

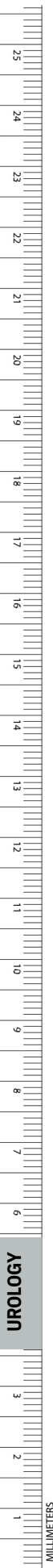

**RANDALL Kidney Stone Forceps
 (continued)**

Catalog Number	Jaw	Length (in.)
PMSEF051R	SLIGHT-CVD	8 7/8
PMSEF052R	CVD	8 7/8
PMSEF053R	HEAVY-CVD	8 7/8
PMSEB246R	HEAVY CVD, VERY DELICATE	9
PMSEF054R	U-CVD	8 7/8
PMSEB244R	90° ANG	9 5/8

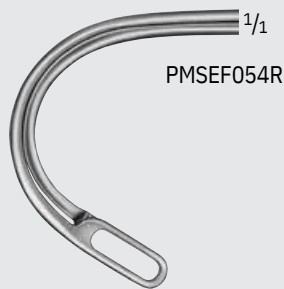
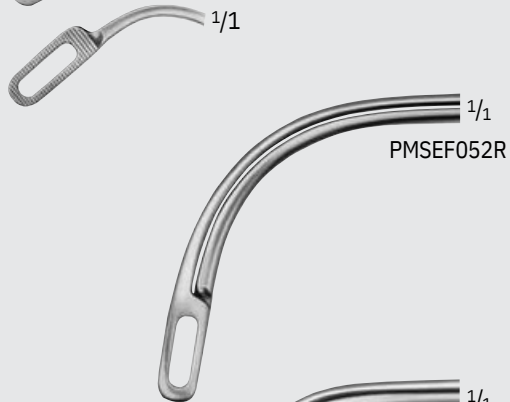
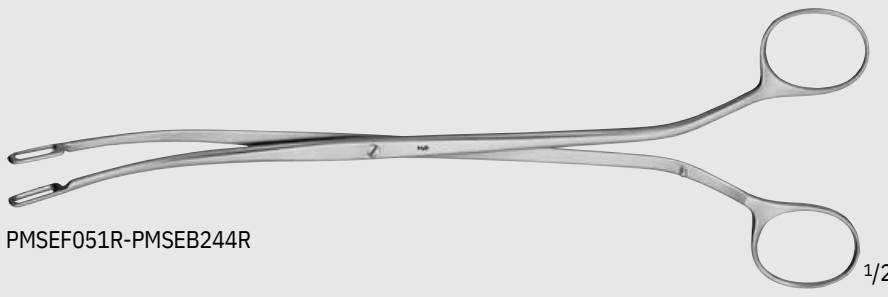

Urology

Forceps and Clamps

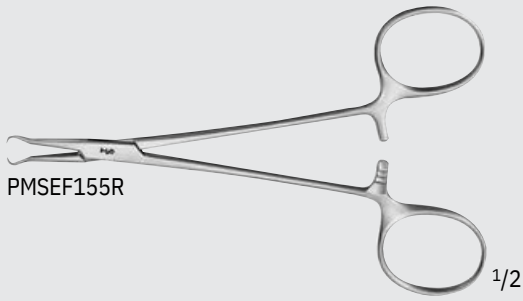

Genitourinary Forceps (F/ No Scalpel Set)

Catalog Number	Length (in.)
PMSEF155R	5

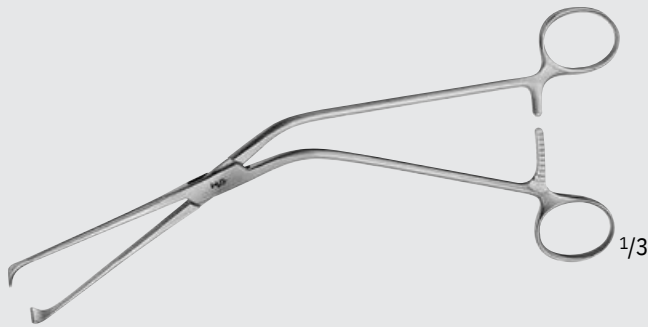

MILLIN Atraumatic Lobe Forceps

Catalog Number	Length (in.)
PMSEF163R	9 5/8

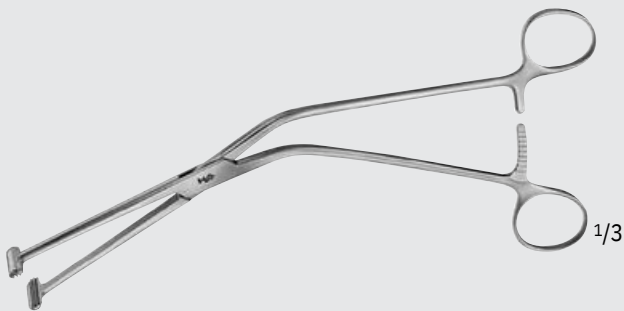
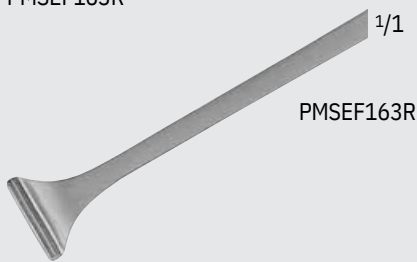

MILLIN Atraumatic T-Shaped Lobe Forceps

Catalog Number	Length (in.)
PMSEF164R	9 1/4

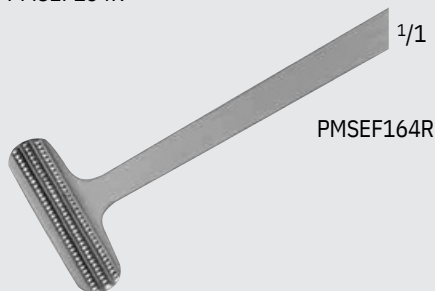

UROLOGY

MATHIEU Foreign Body Forceps

Catalog Number	Shaft Length (in.)
PMSEF928R	7 1/2

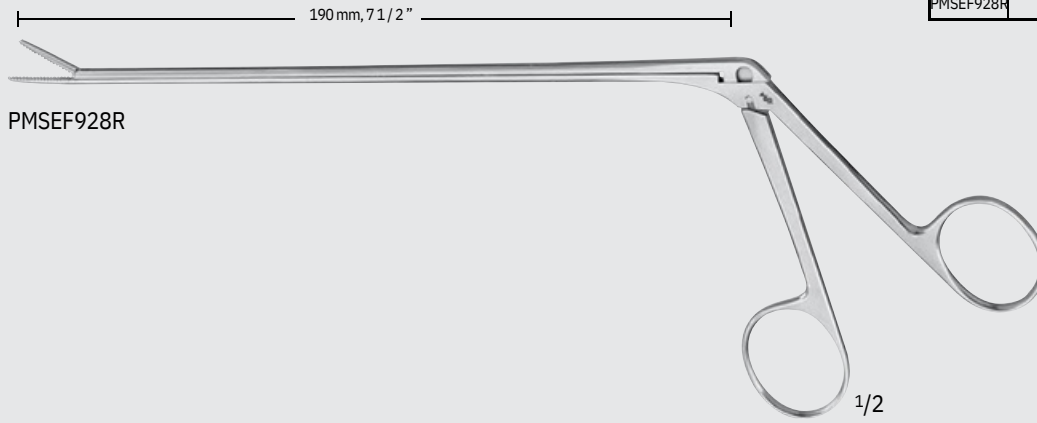

PMSEF928R

1/2

Spermatic Cord Fixation Clamp

Catalog Number	Length (in.)
PMSEF195R	5 3/4

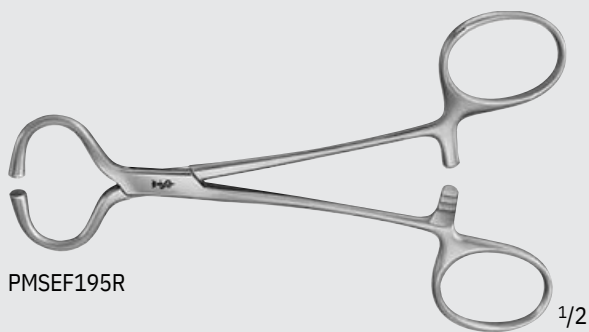

PMSEF195R

1/2

LEADER Vas Isolation Forceps

Catalog Number	Length (in.)
PMSMG452R	5 1/4

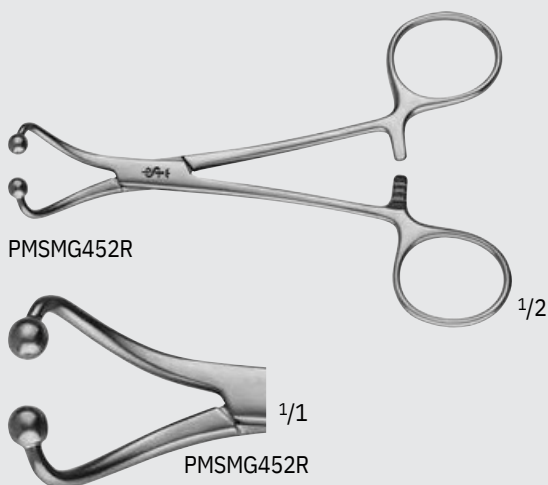

PMSMG452R

1/2

1/1

PMSMG452R



Urology

Forceps and Clamps

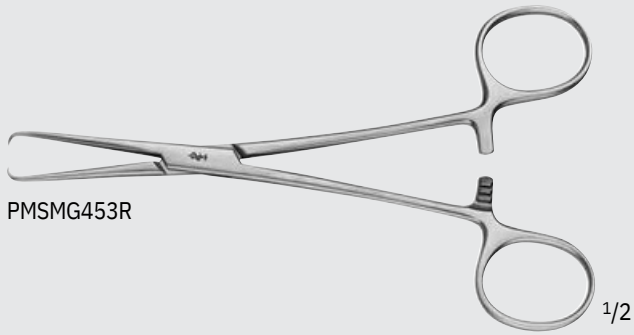

PMSMG453R

1/2



1/1

PMSMG453R

SANDERS Vasectomy Forceps

Catalog Number	Tip	Length (in.)
PMSMG453R	1 x 1 PRONGS	6 1/8

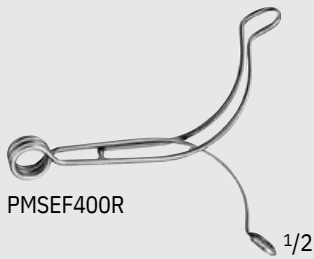

PMSEF400R

1/2

STOCKMANN Penis Clamp

Catalog Number	Length (in.)
PMSEF400R	2 3/4



PMSEF401R

1/2

STRAUSS Penis Clamp

Catalog Number	Length (in.)
PMSEF401R	5 1/8



PMSMG207R

ZIPSER Meatus Clamp

Catalog Number	Length (in.)
PMSMG207R	4 1/4

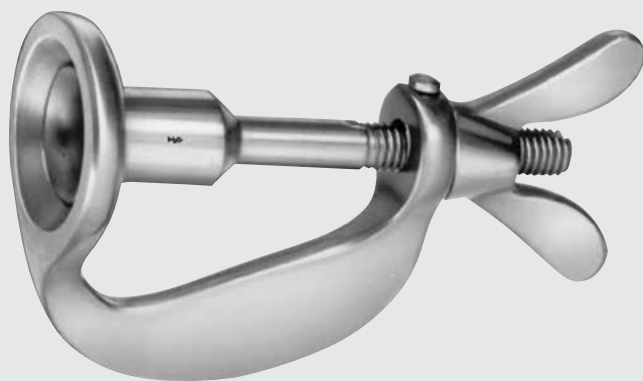

PMSEF965R-PMSEF967R

WINKELMANN Circumcision Clamp

Catalog Number	Diameter (mm)
PMSEF965R	12
PMSEF966R	16
PMSEF967R	20

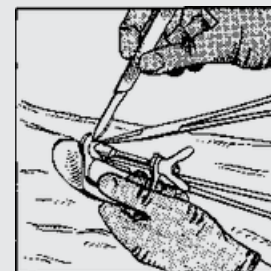
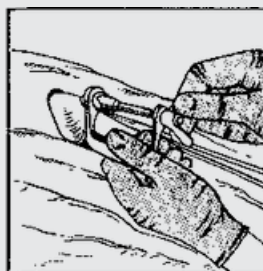

Assisted by two hemostats or ligatures the foreskin is pushed over the bell-shaped protection rod and the glans is placed into it. Next, the wing-nut is tightened as close as possible, so the foreskin is annular compressed. The foreskin is cut off with a scalpel adjacent to the compression ring. The circumcision clamp remains in place for a few minutes to avoid bleeding. If any large vein, specially the frenular artery, is cut, a ligature must be set. The advantage of the method described is the cosmetically favorable scar which is left after rejection of the small necrotized portion.



Urology

Retractors

LOWSLEY Prostatic Tractor

Catalog Number	Tip	Tip Size (FR)	Working Length (in.)	Length (in.)
PMSMG080R	STR	20	9	12 1/4
PMSMG079R	CVD	20	9 1/2	12 3/4



PMSMG080R-PMSMG079R



1/1
PMSMG080R-PMSMG079R

YOUNG Prostatic Tractor, Short

Catalog Number	Tip Size (mm)	Length (in.)
PMSMG250R	25 x 25	8 5/8

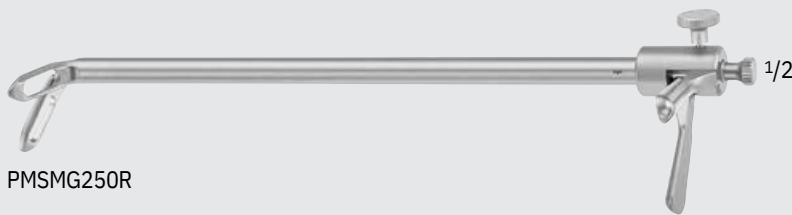

PMSMG250R



1/1
PMSMG250R

LEGUEU Bladder Spatula Retractor

Catalog Number	Blade Size (mm)	Length (in.)
PMSBV928R	35 / 90	10 1/4



35 mm, 1 3/8\"/>

PMSBV928R

WYLIE Renal Vein Retractor

Catalog Number	Blade Size (mm)	Length (in.)
PMSMG179R	25 x 100	13 3/4
PMSMG066R	25 x 175	12 3/4



PMSMG066R-PMSMG179R

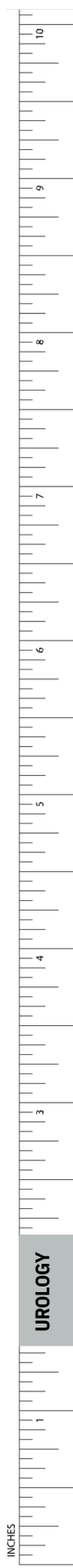

Urology

Retractors

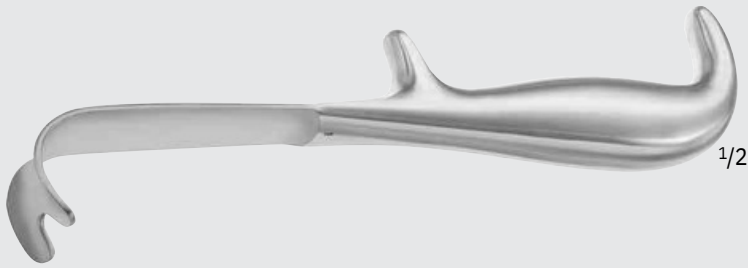

PMSMG248R



PMSMG248R

YOUNG Bulb Retractor

Catalog Number	Blade Size (mm)	Length (in.)
PMSMG248R	25 x 25	8 5/8

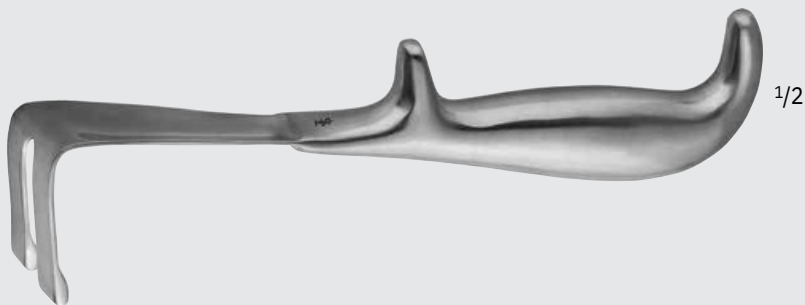

PMSMG249R

YOUNG Prostatic Retractor, Bifurcated Blade W/ Deep Slots

Catalog Number	Blade Size (mm)	Length (in.)
PMSMG249R	1 1/2 x 1 5/8	7 7/8

UROLOGY

YOUNG Lateral Retractor

Catalog Number	Blade Size (mm)	Length (in.)
PMSMG180R	50 x 11	8 1/4



PMSMG180R

1/2

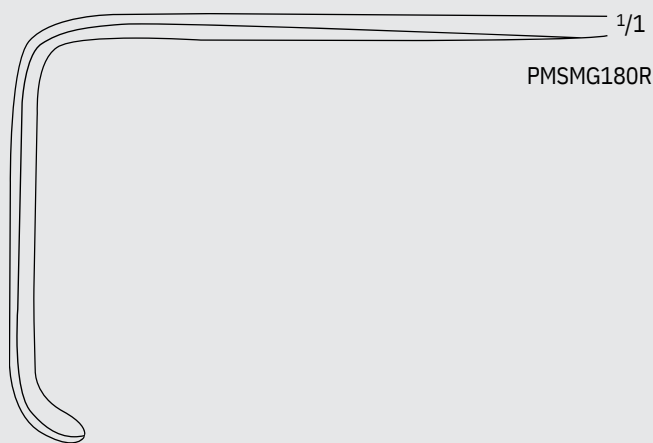

PMSMG180R

1/1

YOUNG Anterior Retractor

Catalog Number	Blade Size (mm)	Length (in.)
PMSMG181R	60 x 40	7 5/8

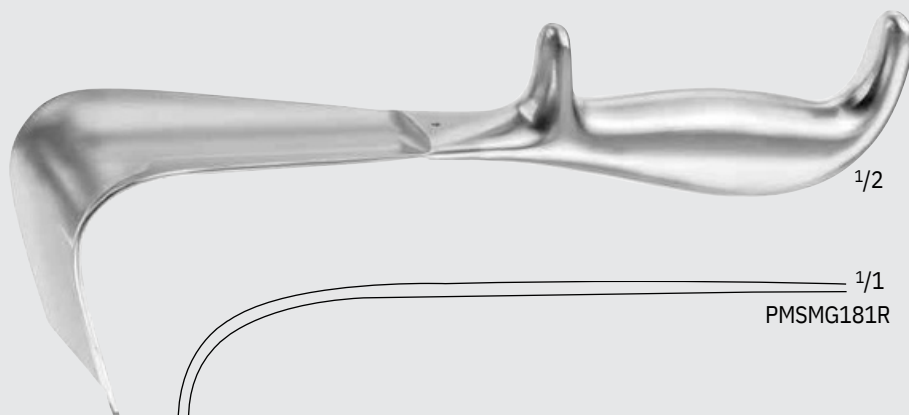

PMSMG181R

1/2

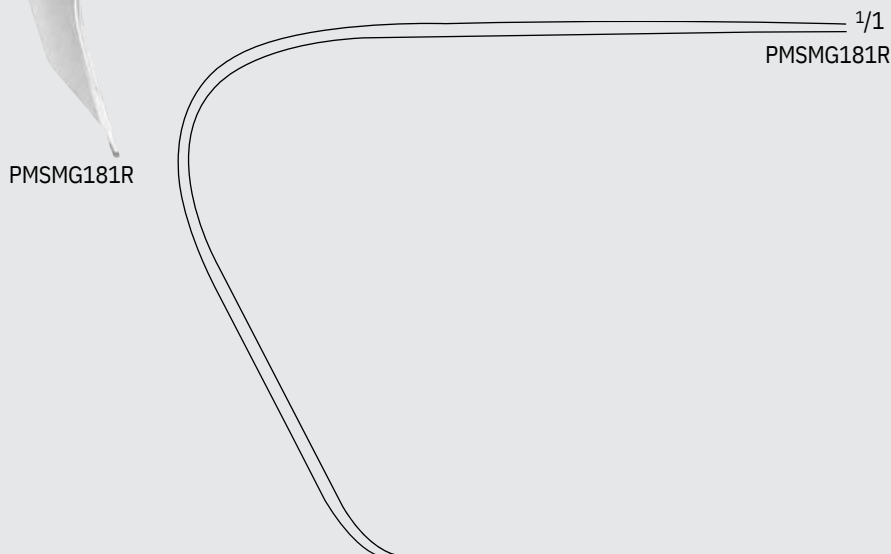

PMSMG181R

1/1



INCHES

Urology

Retractors



PMSBT210R-PMSBT217R

1/2

GIL VERNET Vein Retractor

Catalog Number	Blade Size (mm)	Length (in.)
PMSBT210R	10 x 4	9 1/2
PMSBT211R	10 x 6	9 1/2
PMSBT212R	10 x 8	9 1/2
PMSBT213R	10 x 11	9 1/2
PMSBT214R	13 x 15	9 1/2
PMSBT215R	13 x 17	9 1/2
PMSBT216R	14 x 20	9 1/2
PMSBT217R	16 x 23	9 1/2

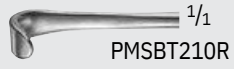

PMSBT210R

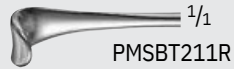

PMSBT211R



PMSBT212R



PMSBT213R



PMSBT214R



PMSBT215R



PMSBT216R



PMSBT217R



PMSBV580R-PMSBV578R

MILLIN Bladder Retractor

Catalog Number	Description
PMSBV580R	COMPLETE SET
PMSBV575R	SPREADER
PMSBV576R	BLADES, 57 x 25 MM
PMSBV577R	BLADES, 82 x 25 MM
PMSBV578R	CENTER BLADE, 105 x 45 MM

PMSBV580R Includes:

- 1 Spreader PMSBV575R
- 1 Center Blade PMSBV578R
- 2 Blades of each PMSBV576R and PMSBV577R

UROLOGY

Female Catheter, Metal

Catalog Number	Tip Size (FR)	Length (in.)
PMSEF306C	6	6 1/4
PMSEF308C	8	6 1/4
PMSEF310C	10	6 1/4
PMSEF312C	12	6 1/4
PMSEF314C	14	6 1/4
PMSEF316C	16	6 1/4
PMSEF318C	18	6 1/4



PMSEF306C-PMSEF318C

GUYON Wire Catheter Guide, Rigid

Catalog Number	Blade	Tip Size (FR)	Length (in.)
PMSEF492R	CVD	7	14 3/8



PMSEF492R

JEWETT Urethral Sound

Catalog Number	Tip Size (FR)	Shape	Length (in.)
PMSMG240R	12	STR	9 1/2
PMSMG241R	14	STR	9 1/2
PMSMG242R	16	STR	9 1/2
PMSMG243R	18	STR	9 1/2
PMSMG244R	20	STR	9 1/2
PMSMG245R	22	STR	9 1/2
PMSMG246R	24	STR	9 1/2
PMSMG247R	26	STR	9 1/2
PMSMG128R	28	STR	9 1/2
PMSMG129R	30	STR	9 1/2
PMSMG130R	32	STR	9 1/2



PMSMG240R-PMSMG130R



Urology

Catheters / Guides / Sounds



PMSEF638R-PMSEF660R

DITTEL Urethral Sound

Catalog Number	Tip Size (FR)	Length (in.)
PMSEF638R	8	13 1/2
PMSEF639R	9	13 1/2
PMSEF640R	10	13 1/2
PMSEF641R	11	13 1/2
PMSEF642R	12	13 1/2
PMSEF643R	13	13 1/2
PMSEF644R	14	13 1/2
PMSEF645R	15	13 1/2
PMSEF646R	16	13 1/2
PMSEF647R	17	13 1/2
PMSEF648R	18	13 1/2
PMSEF649R	19	13 1/2
PMSEF650R	20	13 1/2
PMSEF651R	21	13 1/2
PMSEF652R	22	13 1/2
PMSEF653R	23	13 1/2
PMSEF654R	24	13 1/2
PMSEF655R	25	13 1/2
PMSEF656R	26	13 1/2
PMSEF657R	27	13 1/2
PMSEF658R	28	13 1/2
PMSEF659R	29	13 1/2
PMSEF660R	30	13 1/2

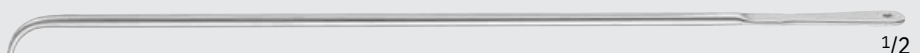

PMSMG131R-PMSMG139R

CAMPBELL Miniature Sound

Catalog Number	Tip Size (FR)	Length (in.)
PMSMG131R	6	9 1/2
PMSMG132R	8	9 1/2
PMSMG133R	10	9 1/2
PMSMG134R	12	9 1/2
PMSMG135R	14	9 1/2
PMSMG136R	16	9 1/2
PMSMG137R	18	9 1/2
PMSMG138R	20	9 1/2
PMSMG139R	22	9 1/2

UROLOGY

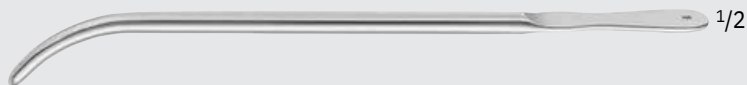

PMSMB805R-PMSMB884R

MCCREA Urethral Sound, Infant/Female

Catalog Number	Tip Size (FR)	Length (in.)
PMSMB805R	8	7 1/4
PMSMB806R	10	7 1/4
PMSMB809R	12	7 1/4
PMSMB810R	14	7 1/4
PMSMB811R	16	7 1/4
PMSMB813R	18	7 1/4
PMSMB814R	20	7 1/4
PMSMB815R	22	7 1/4
PMSMB838R	24	7 1/4
PMSMB839R	26	7 1/4
PMSMB840R	28	7 1/4
PMSMB881R	30	7 1/4
PMSMB882R	32	7 1/4
PMSMB883R	34	7 1/4
PMSMB884R	36	7 1/4

VAN BUREN Urethral Sound

Catalog Number	Tip Size (FR)	Length (in.)
PMSEF800R	8	10 5/8
PMSEF801R	10	10 5/8
PMSEF802R	12	10 5/8
PMSEF803R	14	10 5/8
PMSEF804R	16	10 5/8
PMSEF805R	18	10 5/8
PMSEF806R	20	10 5/8
PMSEF807R	22	10 5/8
PMSEF808R	24	10 5/8
PMSEF809R	26	10 5/8
PMSEF810R	28	10 5/8
PMSEF811R	30	10 5/8
PMSEF812R	32	10 5/8
PMSEF813R	34	10 5/8
PMSEF814R	36	10 5/8
PMSEF815R	38	10 5/8
PMSEF816R	40	10 5/8



PMSEF800R-PMSEF816R



INCHES

Urology

Catheters

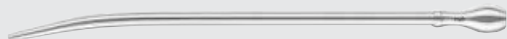

PMSMB158R-PMSMB169R

WALTHER Dilator-Catheter

Catalog Number	Tip Size (FR)	Length (in.)
PMSMB158R	12	5 1/4
PMSMB170R	14	5 1/4
PMSMB173R	16	5 1/4
PMSMB159R	18	5 1/4
PMSMB160R	20	5 1/4
PMSMB161R	22	5 1/4
PMSMB162R	24	5 1/4
PMSMB163R	26	5 1/4
PMSMB164R	28	5 1/4
PMSMB165R	30	5 1/4
PMSMB166R	32	5 1/4
PMSMB167R	34	5 1/4
PMSMB168R	36	5 1/4
PMSMB169R	38	6

OTIS Bougies a Boule, Olive Tip

Catalog Number	Tip Size (FR)	Length (in.)
PMSMG111R	8	10
PMSMG112R	10	10
PMSMG113R	12	10
PMSMG114R	14	10
PMSMG115R	16	10
PMSMG116R	18	10
PMSMG117R	20	10
PMSMG118R	22	10
PMSMG119R	24	10
PMSMG120R	26	10
PMSMG121R	28	10
PMSMG122R	30	10
PMSMG123R	32	10
PMSMG124R	34	10
PMSMG125R	36	10
PMSMG126R	38	10
PMSMG127R	40	10



PMSMG111R-PMSMG127R

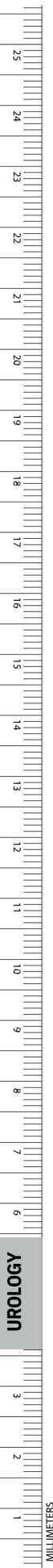
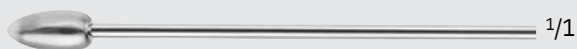



PARKER MEDICAL SUPPLIES

CONTACT US



+1 (832) 343-3140



info@parkermedicalsupplies.com



www.parkermedicalsupplies.com

VISIT US:

2800 Post Oak Blvd, Ste 5600, Houston TX 77056, United States