



PARKER MEDICAL SUPPLIES



PMS ORTHOPEDIC SURGICAL INSTRUMENTS

Product Catalog



+1 (832) 343-3140



info@parkermedicalsupplies.com



www.parkermedicalsupplies.com

2800 Post Oak Blvd, Ste 5600, Houston TX 77056, United States





Orthopedics/Spine

Scissors	880 - 885
Plaster/Nail/Wire Instruments	886 - 898
Meniscus Instruments	899
Forceps	900 - 916
Retractors	917 - 956
Rasps	957 - 959
Elevators and Bone Levers	960 - 973
Chisels/Gouges/Osteotomes	974 - 987
Mallets/Impactors/Bone Tamps	988 - 994
Drills/Burr/Reamers	995 - 996
Reamers and Trephines	997
Curettes	998 - 1013
Microdissectomy Instruments	1014 - 1018
Dissectors and Probes	1019
Rongeurs	1020 - 1049
Kerrison Bone Punches	1050 - 1057
KAIRison Pneumatic Bone Punch	1058 - 1059
Bone Cutters	1060 - 1063
Rulers, Calipers and Gauges	1064 - 1065

Orthopedics/Spine

Scissors



PMSBC881R-PMSBC989R

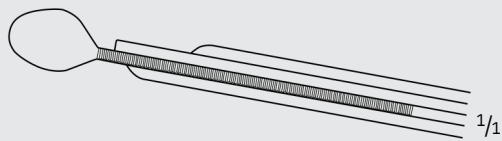

PMSBC881R-PMSBC989R

Universal Bandage Scissors

Catalog Number	Handle Color	Length (in.)
PMSBC881R	BLACK	7
PMSBC980R	RED	7
PMSBC981R	BLUE	7
PMSBC983R	YELLOW	7
PMSBC985R	ORANGE	7
PMSBC987R	PINK	7
PMSBC988R	LIGHT GREEN	7
PMSBC989R	VIOLET	7



PMSBC885R-PMSBC979R

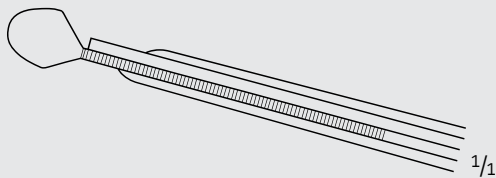

PMSBC885R-PMSBC979R

LISTER Universal Bandage Scissors

Catalog Number	Handle Color	Length (in.)
PMSBC885R	BLACK	5 3/4
PMSBC970R	RED	5 3/4
PMSBC971R	BLUE	5 3/4
PMSBC973R	YELLOW	5 3/4
PMSBC975R	ORANGE	5 3/4
PMSBC977R	PINK	5 3/4
PMSBC978R	LIGHT GREEN	5 3/4
PMSBC979R	VIOLET	5 3/4



LISTER Bandage Scissors, Serrated

Catalog Number	Length (in.)
PMSMB146R	3 1/2
PMSBC876R	6 1/4

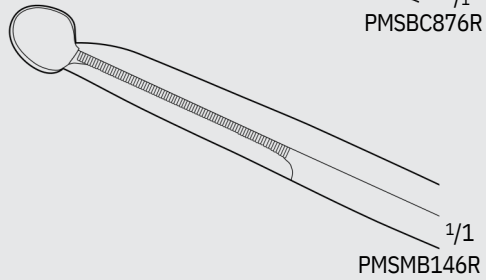
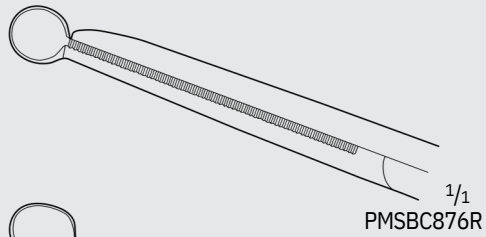

Orthopedics/Spine

Scissors



PMSBC848R-PMSBC863R

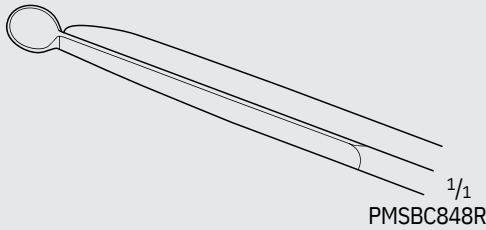

PMSBC848R

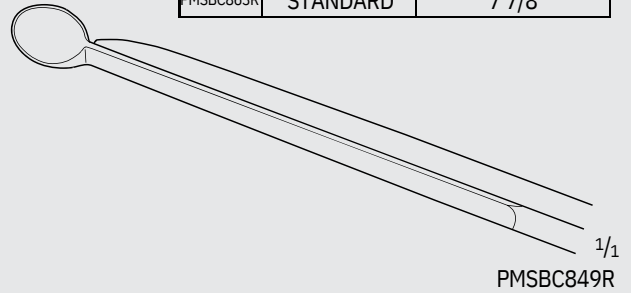

PMSBC849R

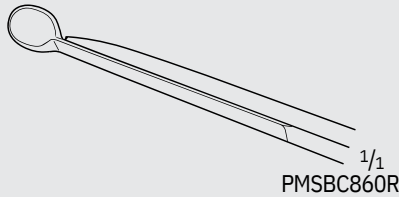

PMSBC860R

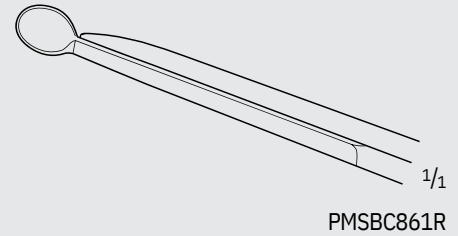

PMSBC861R

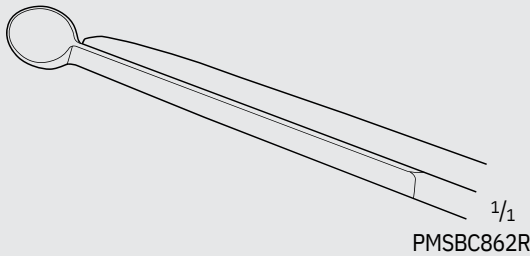

PMSBC862R

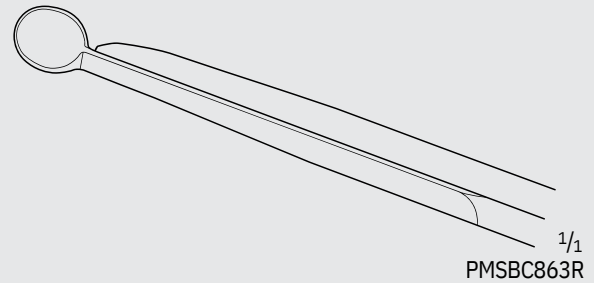

PMSBC863R

LISTER Bandage Scissors

Catalog Number	Blade	Length (in.)
PMSBC848R	LONG	6 1/8
PMSBC849R	LONG	7
PMSBC860R	STANDARD	4 1/2
PMSBC861R	STANDARD	5 1/2
PMSBC862R	STANDARD	7
PMSBC863R	STANDARD	7 7/8



PMSMB223



PMSMB223

LISTER Bandage Scissors W/ One Large Ring

Catalog Number	Length (in.)
PMSMB223	8



ORTHO
SPINE

MILLIMETERS

Plaster and Bandage Scissors

Catalog Number	Length (in.)
PMSLX558R	9 1/4

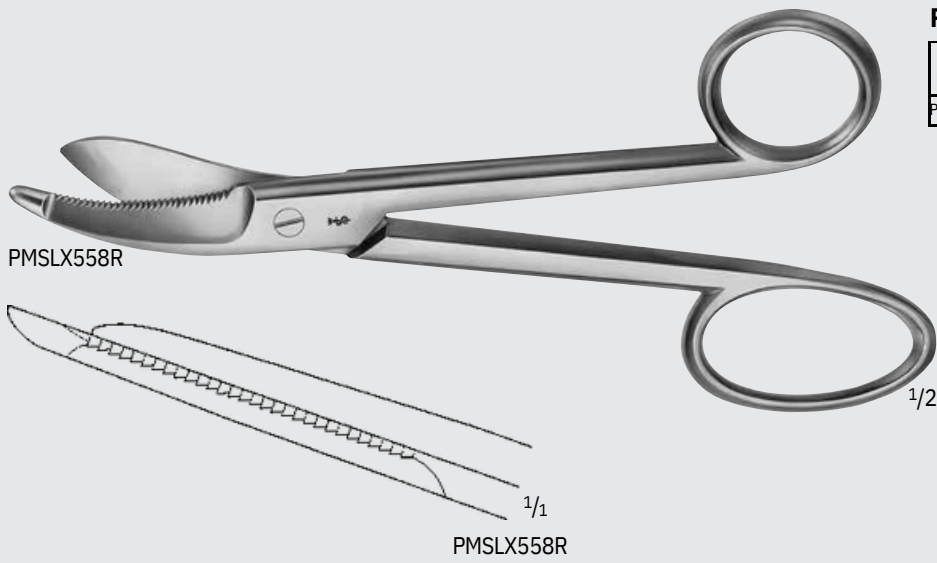

Plaster Scissors

Catalog Number	Length (in.)
PMSLX548R	6 1/4



BRUNS Plaster Scissors

Catalog Number	Length (in.)
PMSLX556R	9 1/4

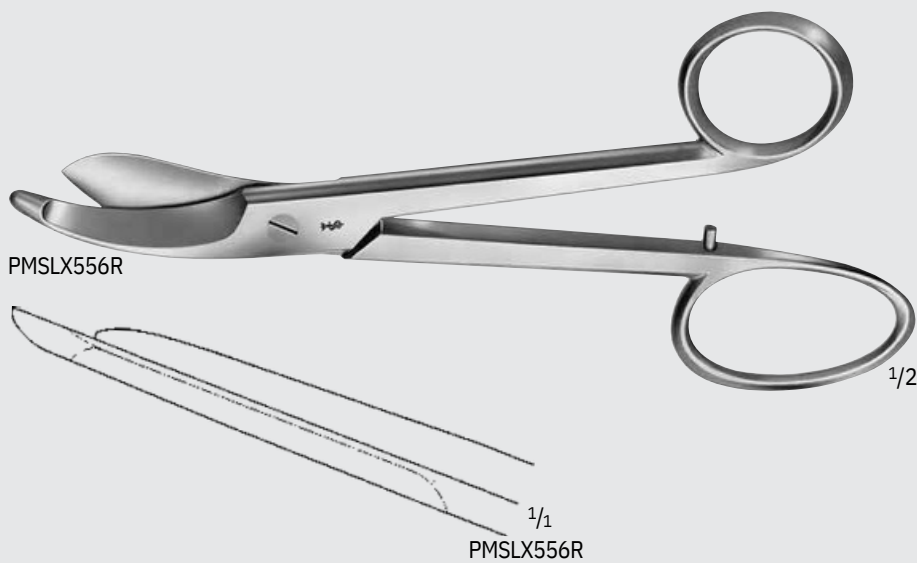

Orthopedics/Spine

Scissors

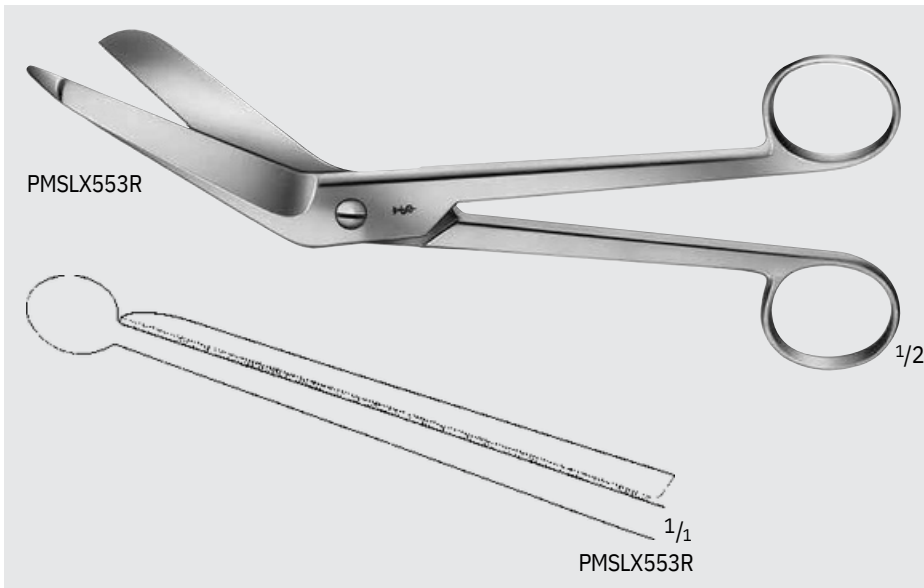

BERGMANN Plaster Scissors

Catalog Number	Length (in.)
PMSLX553R	9

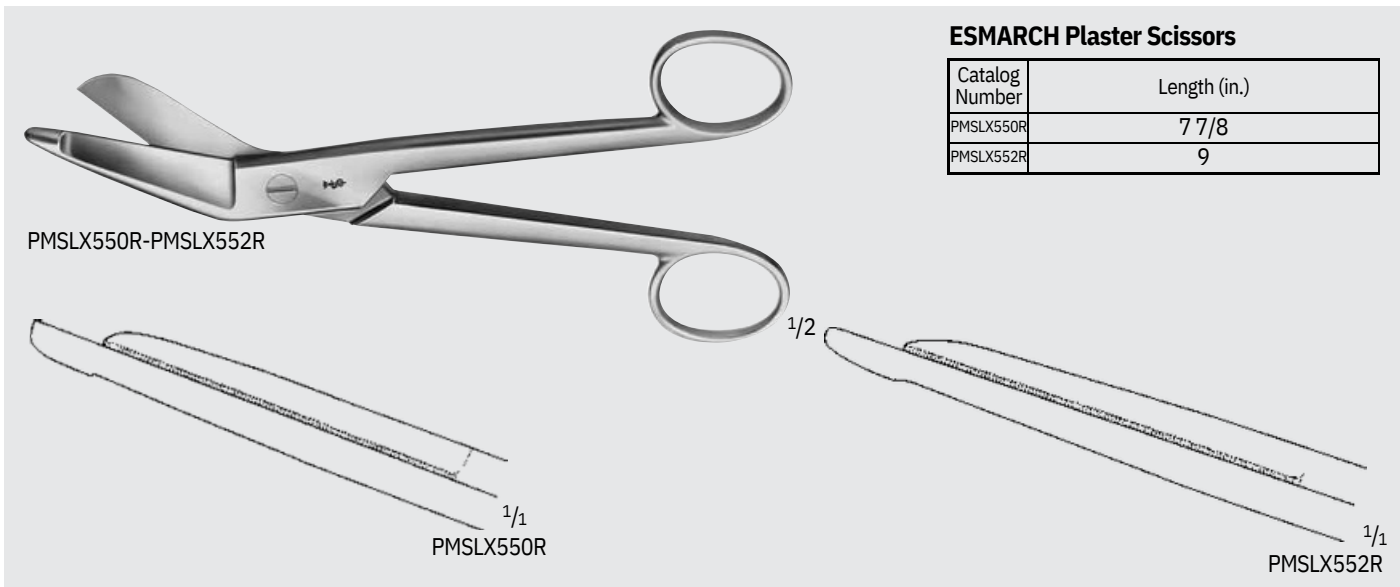

ESMARCH Plaster Scissors

Catalog Number	Length (in.)
PMSLX550R	7 7/8
PMSLX552R	9



HERCULES Plaster Shears

Catalog Number	Length (in.)
PMSMB106R	7 1/2

Plaster Scissors

Catalog Number	Length (in.)
PMSBC888R	8

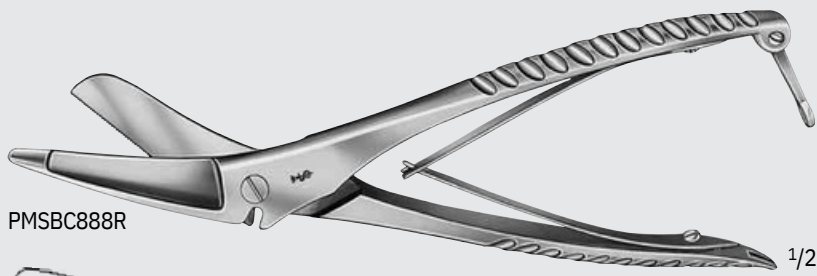

PMSBC888R

1/2

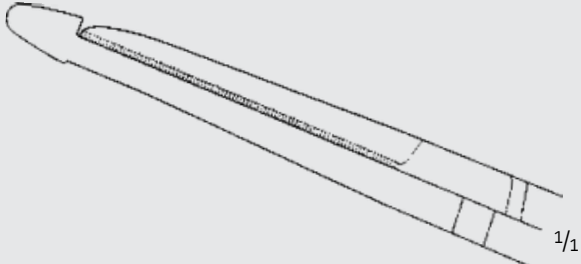

1/1

PMSBC888R

SEUTIN Plaster and Bandage Scissors

Catalog Number	Length (in.)
PMSLX565R	9



PMSLX565R

1/2

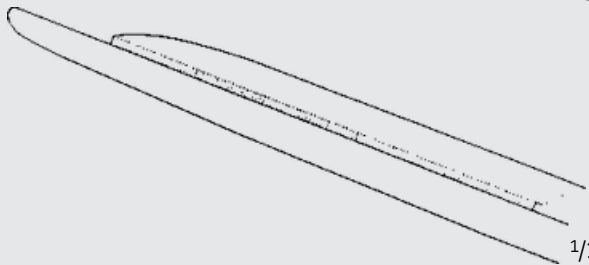

1/1

PMSLX565R

RESANO Cartilage Scissors

Catalog Number	Tip	Blade	Length (in.)
PMSBC595R	B/B	ANG	9 3/4

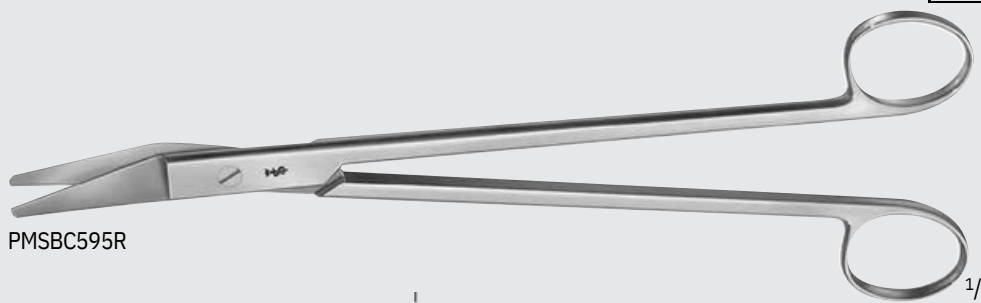

PMSBC595R

1/2

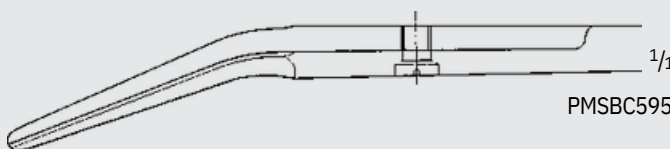

1/1

PMSBC595R



ORTHO SPINE

INCHES

Orthopedics/Spine

Plaster and Nail Instruments



PMSLX600R

1/3

HENNIG Plaster Spreader

Catalog Number	Length (in.)
PMSLX600R	10 5/8



PMSLX605R

1/3

Plaster Spreader

Catalog Number	Length (in.)
PMSLX605R	9



PMSLX618R-PMSLX624R

1/2

WOLFF Plaster Breaker

Catalog Number	Length (in.)
PMSLX618R	7
PMSLX624R	9 1/2



PMSHF213R

1/2



1/1

PMSHF213R

Nail Cutter

Catalog Number	Length (in.)
PMSHF213R	5 1/4

ORTHO
SPINE

MILLIMETERS

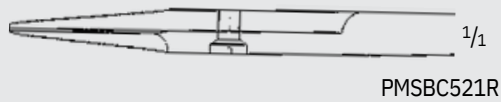

SYSTRUNK Nail Splitting Scissors

Catalog Number	Tip	Blade	Length (in.)
PMSBC521R	S/S	STR	5 1/8

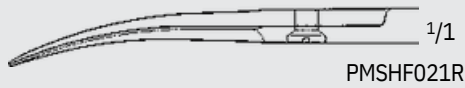

Nail Scissors

Catalog Number	Tip	Blade	Length (in.)
PMSHF021R	S/S	CVD	4 1/4

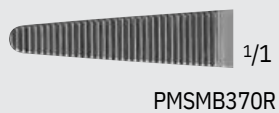

Needle Nose Pliers/Wire Cutters

Catalog Number	Length (in.)
PMSMB370R	7 1/4



Orthopedics/Spine

Wire Instruments

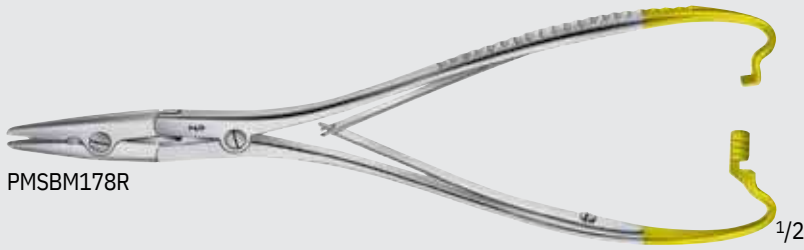

PMSBM178R

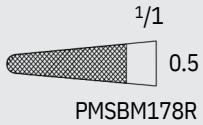

DUROGRIP™ TC AESCULAP Needle Holder, Double Action

Catalog Number	Handle	Jaw	Length (in.)
PMSBM178R	RATCHET	SERR	7 7/8



PMSLX150R



PMSLX152R

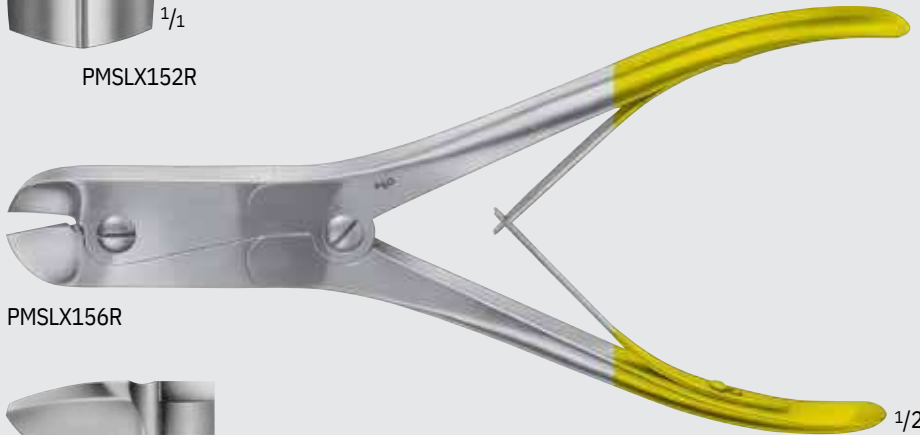

PMSLX156R



Wire Cutter, W/ Specially Hardened Cutting Edges

Catalog Number	For Wire Size	Length (in.)
PMSLX150R	SOFT, UP TO 2MM AND HARD, UP TO 1.5MM	5 3/4
PMSLX152R	SOFT, UP TO 3.5MM AND HARD, UP TO 2.0MM	8 3/4
PMSLX156R	SOFT, UP TO 3MM AND HARD, UP TO 2.2MM	9 1/4

ORTHO
SPINE

MILLIMETERS

HARVEY Wire Cutter, W/ Specially Hardened Cutting Edges

Catalog Number	For Wire Size	Tip	Length (in.)
PMSLX157R	SOFT, UP TO 3MM AND HARD, UP TO 2.2MM	ANG	9 1/4



PMSLX157R

1/2

Wire Cutter, Front and Lateral, W/ Specially Hardened Cutting Edges

Catalog Number	Wire Size	Length (in.)
PMSLX158R	SOFT, UP TO 2MM AND HARD, UP TO 1.5MM	7



PMSLX158R

1/2



1/1

PMSLX158R



Orthopedics/Spine

Wire Instruments



PMSLX159R

1/2



1/1

PMSLX159R

REILL Cutter, F/ Wire Close To Bone, W/ Specially Hardened Cutting Edges

Catalog Number	For Wire Size	Length (in.)
PMSLX159R	SOFT, UP TO 2MM AND HARD, UP TO 1.5MM	6 7/8

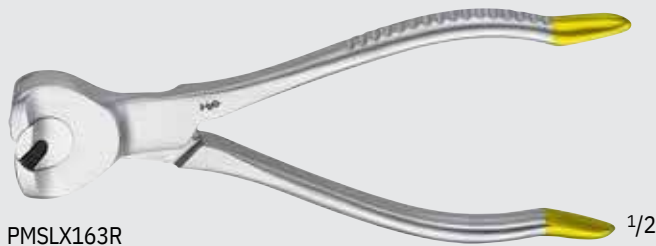

PMSLX163R

1/2



1/1

PMSLX163R

Front Cutter, W/ Specially Hardened Cutting Edges

Catalog Number	For Wire Size	Length (in.)
PMSLX163R	SOFT, UP TO 3.5MM AND HARD, UP TO 2.5MM	6 1/2



PMSLX162R

1/2

TC Wire Cutter W/ Carbide Cutting Edges

Catalog Number	Length (in.)
PMSLX162R	9 1/2



ORTHO
SPINE

TC Wire Cutter Double Action

Catalog Number	Packaging	Tip	Length (in.)
PMSMG025R	2.5	ANG	8 3/4

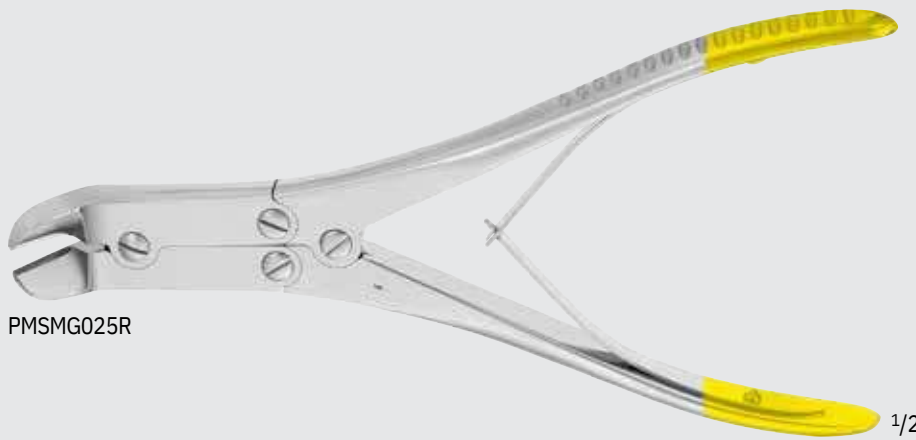

PMSMG025R



PMSMG025R

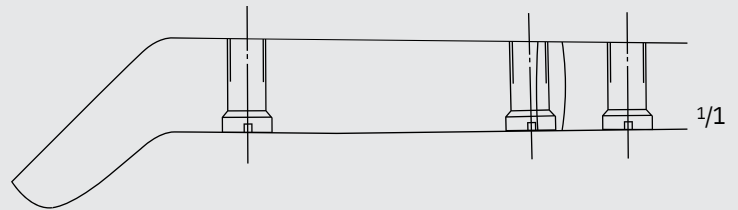

TC Flush Wire Cutter

Catalog Number	Packaging	Tip	Length (in.)
PMSMG029R	1.6	FRONT AND LATERAL	6 3/4



PMSMG029R



INCHES

Orthopedics/Spine

Wire Instruments

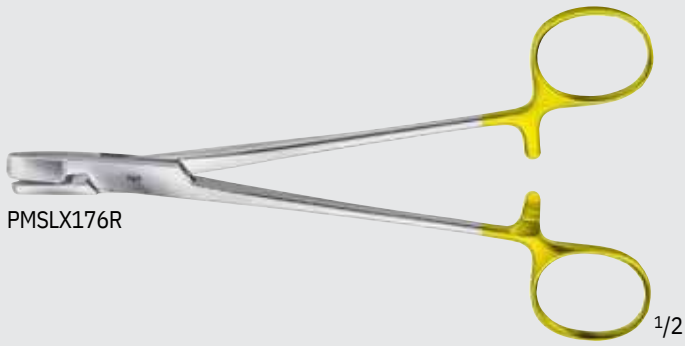

Wire Holding Forceps W/Hard Metal Inserts

Catalog Number	Length (in.)
PMSLX176R	6 3/4

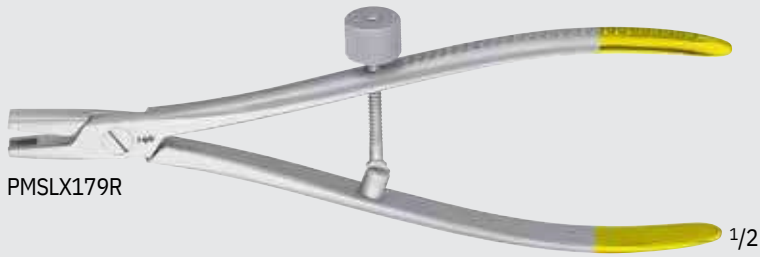

Wire Grasping Forceps W/Hard Metal Inserts

Catalog Number	Tip	Length (in.)
PMSLX179R	FLAT	7 1/2



HERCULES Pin Cutter

Catalog Number	Packaging	Description	Length (in.)
PMSMG088R	3	TUNGSTEN CARBIDE	8 3/4



PMSMG088R

1/2

Pin Cutter, End-Cutting

Catalog Number	Packaging	Length (in.)
PMSMG089R	4.7	14 3/4 22
PMSMG090R	6.3	1/2

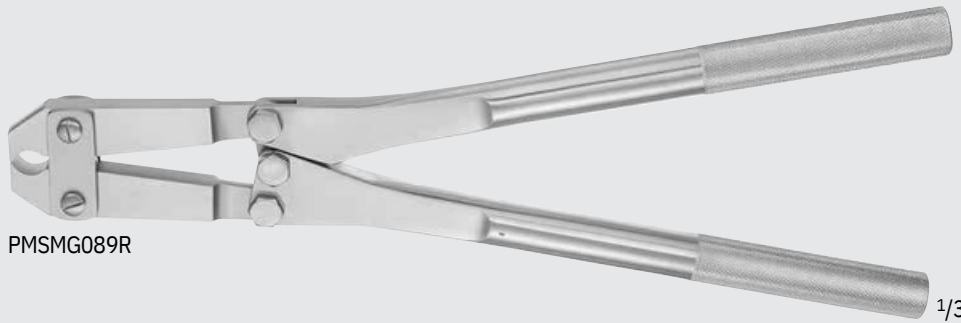

PMSMG089R

1/3

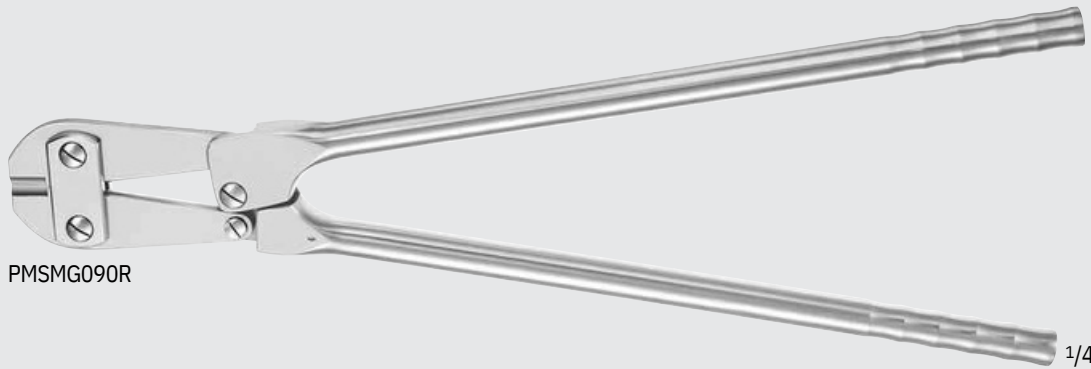

PMSMG090R

1/4



ORTHO
SPINE

INCHES

Orthopedics/Spine

Wire Instruments

Bolt Cutter

Catalog Number	Item	Length (in.)
PMSLX164R	F/KIRSCHNER WIRES, TIBIA HEAD SCREWS, BOLTS, PINS, UP TO 6MM	18 1/2

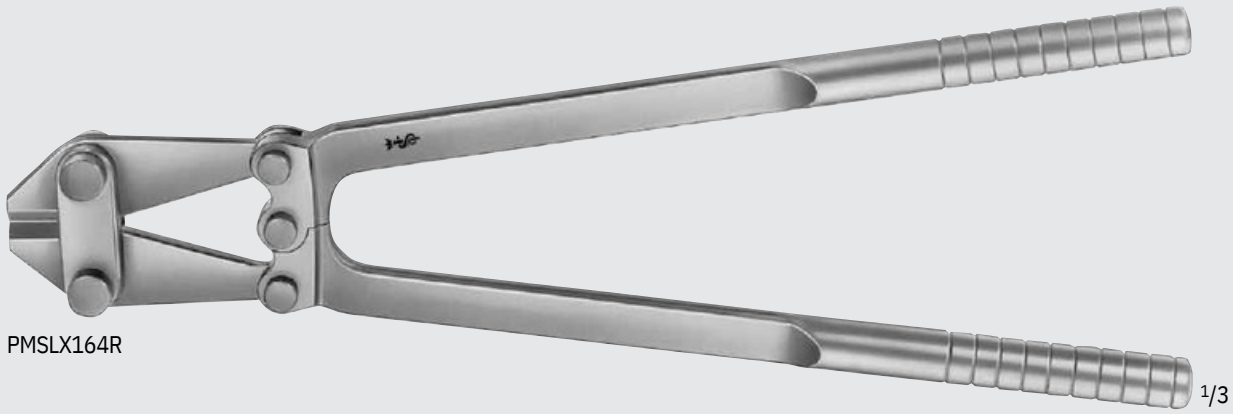

PMSLX164R

Bolt Cutter

Catalog Number	Item	Length (in.)
PMSLX165R	F/KIRSCHNER WIRES, TIBIA HEAD SCREWS, BOLTS, PINS, UP TO 6MM	12 1/2



PMSLX165R



PMSLX165R

ORTHO
SPINE

MILLIMETERS

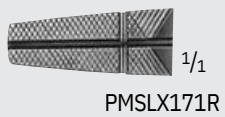

Wire Holding Pliers

Catalog Number	Tip	Length (in.)
PMSLX170R	SERR	6 3/4
PMSLX171R	CROSS-GROOVES	6 3/4

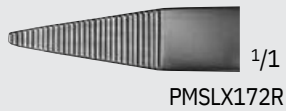
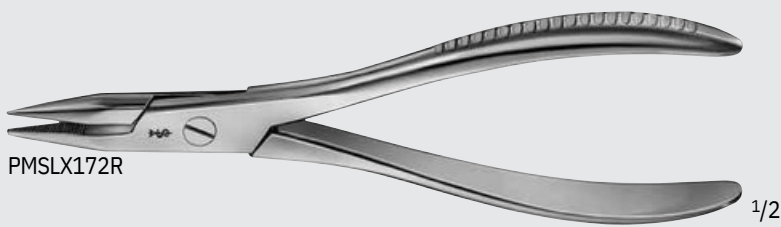

Wire Holding Forceps

Catalog Number	Tip	Length (in.)
PMSLX172R	SERR	7 1/2

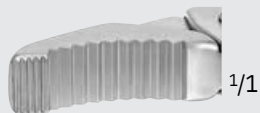

Wire Holding Pliers

Catalog Number	Tip	Tip Size (mm)	Length (in.)
MGPMS026R	LOCKING	7	7



ORTHO
SPINE

INCHES

Orthopedics/Spine

Wire Instruments



Wire Holding Needle-Nose Pliers

Catalog Number	Tip	Tip Size (mm)	Length (in.)
PMSG028R	LOCKING, NEEDLE-NOSE	5	9 1/2

PMSG028R

1/2



1/1

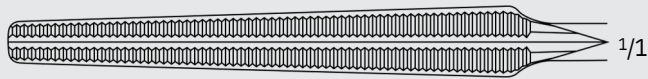

1/1

PMSG028R



Vise Grip Pliers

Catalog Number	Tip	Length (in.)
PMSLX174R	FLAT NOSE	7 7/8

PMSLX174R

1/2



1/1

PMSLX174R

ORTHO
SPINE

MILLIMETERS



PMSLX175S

1/2

Bending Iron

Catalog Number	FOR BORING WIRE SIZE	Length (in.)
PMSLX175S	UP TO 2.7MM	4 3/4

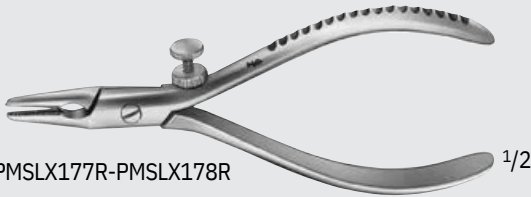

PMSLX177R-PMSLX178R

1/2

Wire Extraction Pliers

Catalog Number	Length (in.)
PMSLX177R	5 1/8
PMSLX178R	7



1/1



1/1



1/1



1/1

PMSLX177R

PMSLX178R



PMSLX181R-PMSLX185R

1/2

Wire Extraction Pliers

Catalog Number	Tip	Length (in.)
PMSLX181R	RND	7
PMSLX182R	RND, SHORT JAW	7
PMSLX183R	FLAT	7
PMSLX185R	PARALLEL	5 3/4

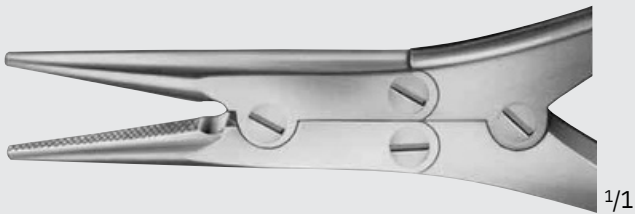

1/1



1/1

PMSLX181R

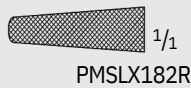

1/1

PMSLX182R

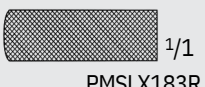

1/1

PMSLX183R



1/1

PMSLX185R



ORTHO SPINE

INCHES

Orthopedics/Spine

Wire Instruments

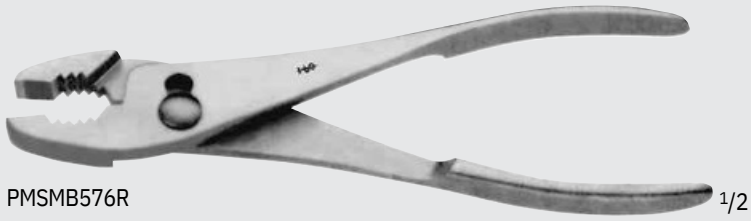

PMSMB576R

1/2

Utility Pliers

Catalog Number	Length (in.)
PMSMB576R	7 3/4



PMSLX189R

1/2



1/1



1/1

PMSLX189R

Flat Nosed Pliers

Catalog Number	Tip	Length (in.)
PMSLX189R	PARALLEL	7 1/4

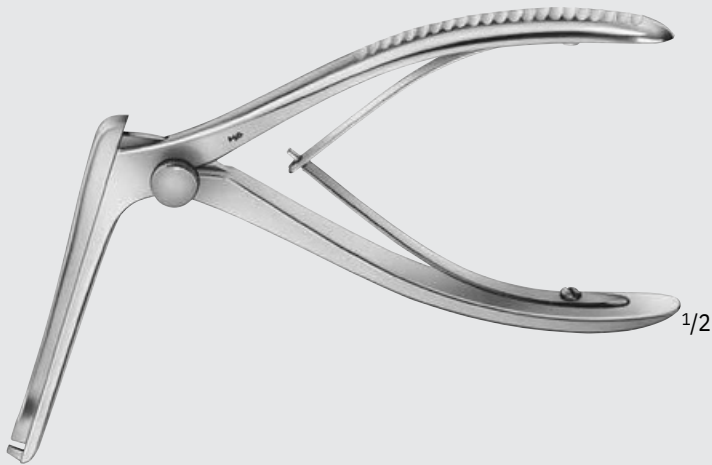

PMSLX190R

1/2

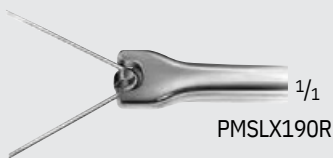

1/1

PMSLX190R

Wire Bending Pliers

Catalog Number	For Wire Size
PMSLX190R	UP TO 1.8MM



SMILLIE Meniscotome

Catalog Number	Jaw	Length (in.)
PMSFO857R	STRAIGHT	6 3/4
PMSFO855R	LEFT	6 3/4
PMSFO856R	RIGHT	6 3/4

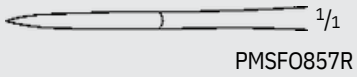
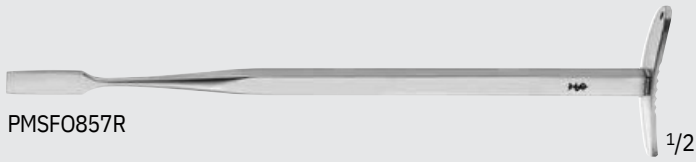

Orthopedics/Spine

Forceps

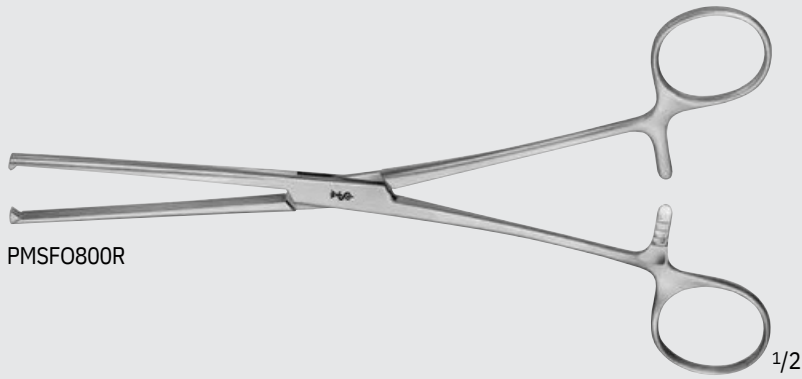

PMSFO800R

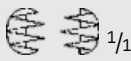

PMSFO800R

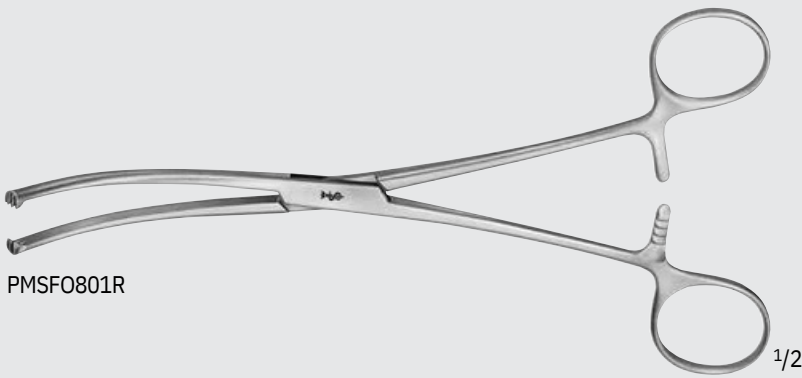

PMSFO801R

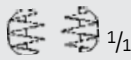

PMSFO801R

BIRCHER Cartilage Forceps

Catalog Number	Jaw	Length (in.)
PMSFO800R	STR	7 7/8
PMSFO801R	CVD	7 7/8



ORTHO
SPINE

WELLER Cartilage Forceps

Catalog Number	Jaw	Length (in.)
PMSFO807R	CVD	7 7/8

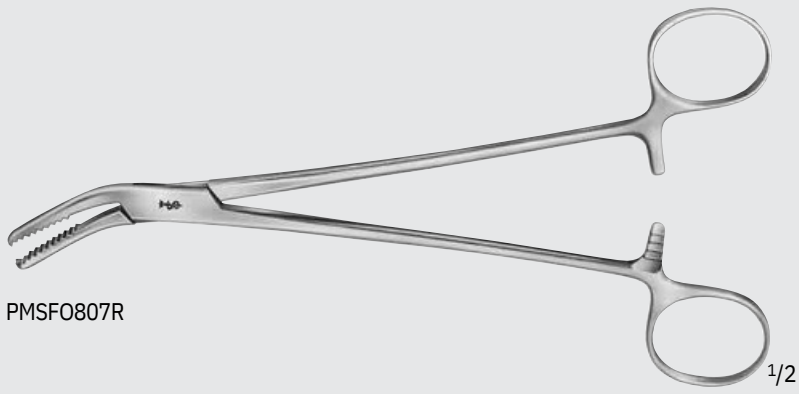

PMSFO807R

1/2



1/1

PMSFO807R

BIRCHER-GANSKE Cartilage Forceps

Catalog Number	Jaw	Length (in.)
PMSFO808R	SLIGHT CVD	7 7/8

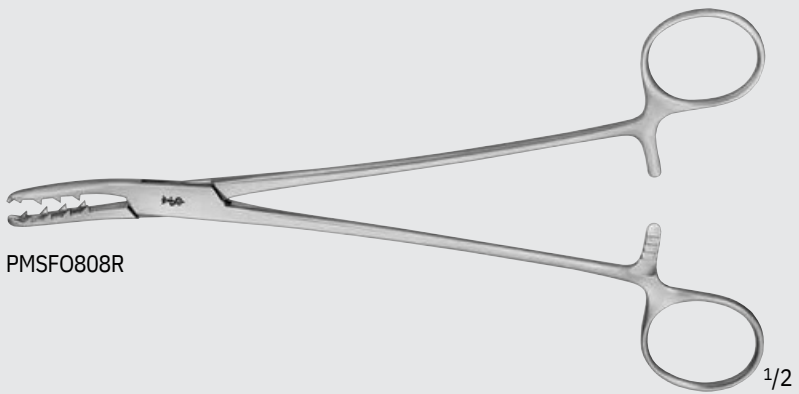

PMSFO808R

1/2



1/1

PMSFO808R

Orthopedics/Spine

Forceps

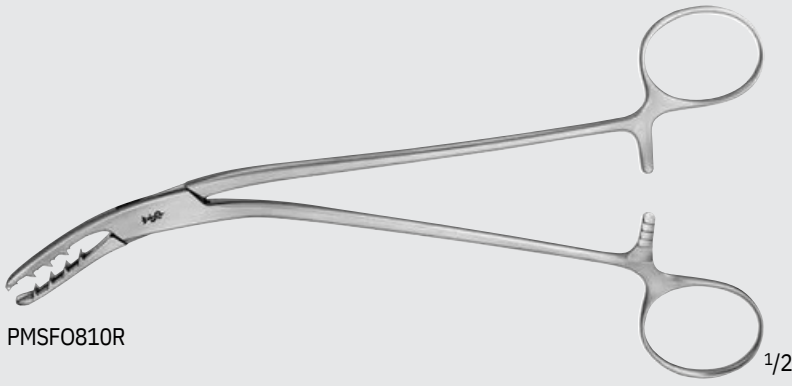

PMSFO810R



PMSFO810R

BIRCHER-GANSKE Cartilage Forceps (continued)

Catalog Number	Jaw	Length (in.)
PMSFO810R	CVD	7 7/8

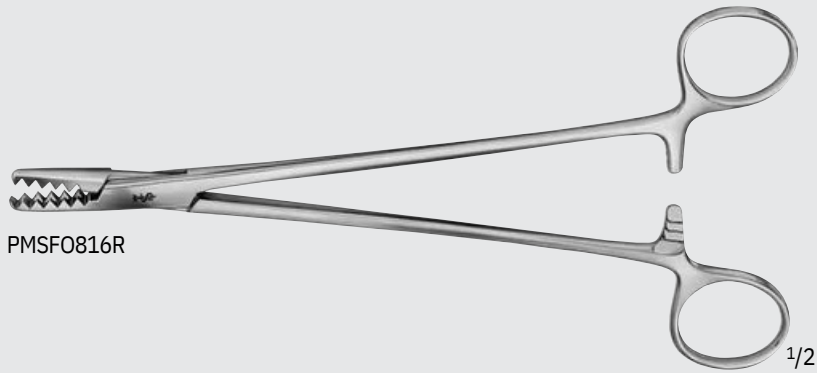

PMSFO816R



PMSFO816R

MARTIN Cartilage Forceps

Catalog Number	Jaw	Length (in.)
PMSFO816R	STR	8

MEYER Reposition Forceps, F/ Wires

Catalog Number	For Wire Size	Length (in.)
PMSFO106R	UP TO 1MM	6 3/4
PMSFO108R	UP TO 2MM	8

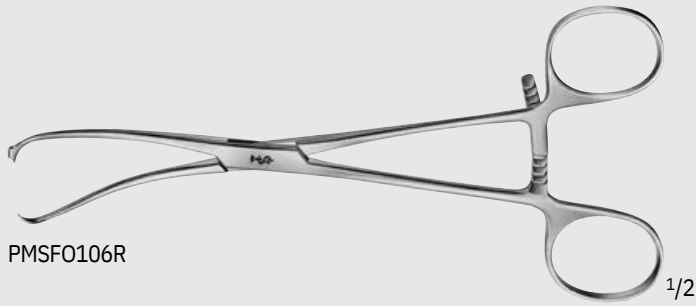

PMSFO106R

1/2



1/1



1/1

PMSFO106R

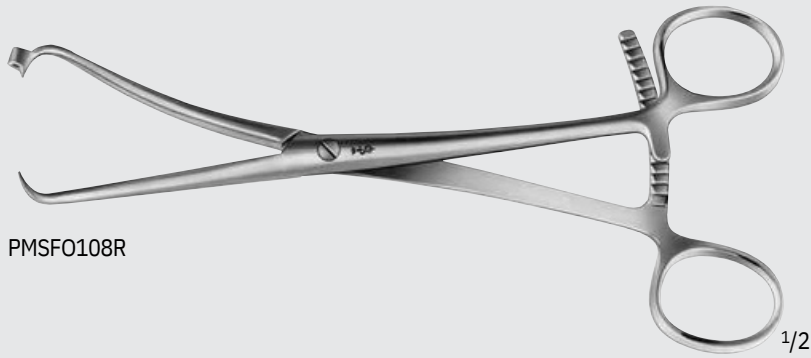

PMSFO108R

1/2

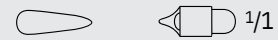

1/1

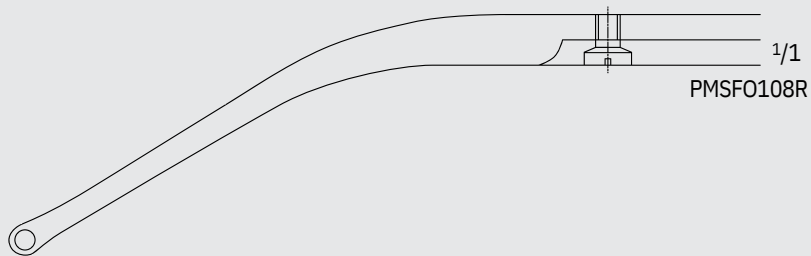

1/1

PMSFO108R



INCHES

Orthopedics/Spine

Bone Holding Forceps

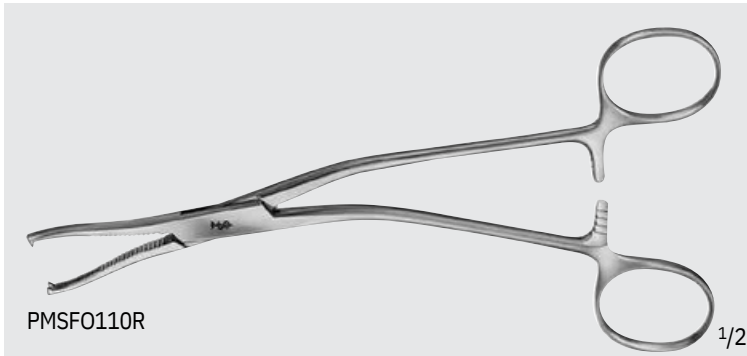

DINGMANN Bone Holding Forceps

Catalog Number	Teeth	Length (in.)
PMSFO110R	2 x 2	7 1/4

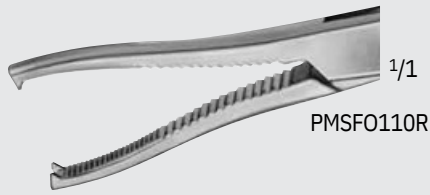

DINGMANN Bone Holding Forceps

Catalog Number	Teeth	Shaft	Length (in.)
PMSFO111R	2 x 2	CVD	7 1/4

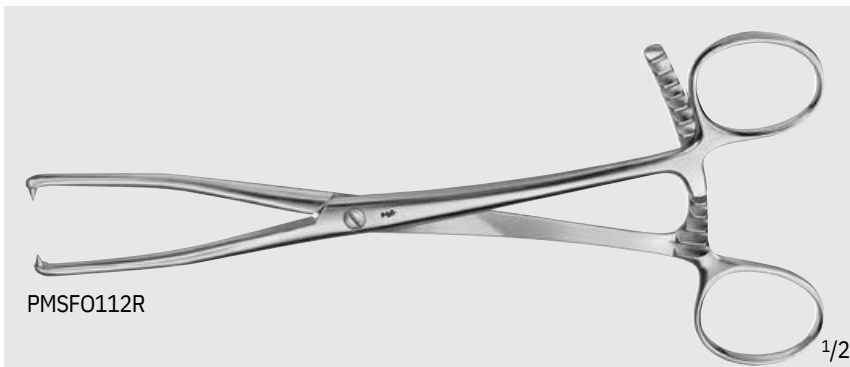
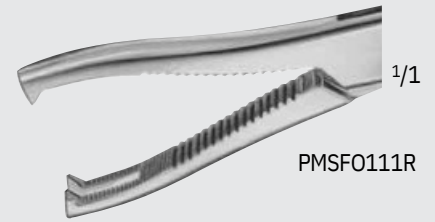

Bone Holding Forceps

Catalog Number	Length (in.)
PMSFO112R	8 1/4

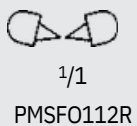

Finger Reposition Forceps, Stepped Tips

Catalog Number	Length (in.)
PMSFO113R	3 3/4

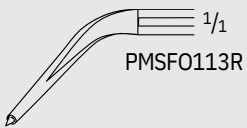

Finger Reposition Forceps, F/ Small Fragments

Catalog Number	Length (in.)
PMSFO115R	5 1/4



REILL Reposition Forceps

Catalog Number	Length (in.)
PMSFO116R	6 3/4



Orthopedics/Spine

Bone Holding Forceps

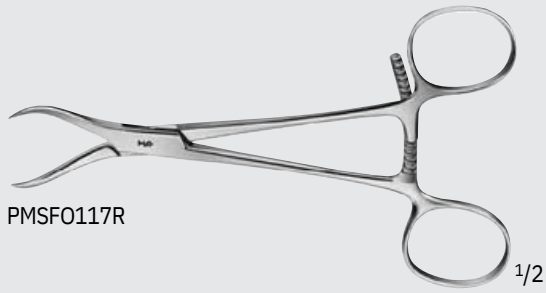

PMSFO117R

1/2

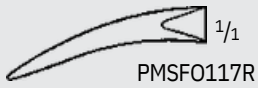

PMSFO117R

1/1

Forceps for Maxillary Reposition

Catalog Number	Length (in.)
PMSFO117R	5 1/4

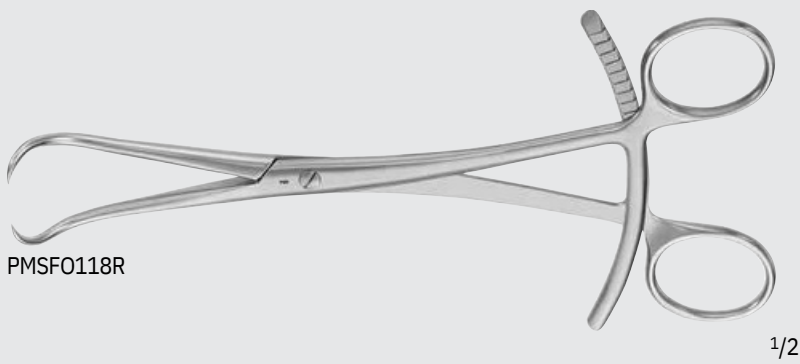

PMSFO118R

1/2

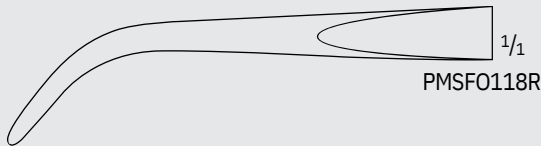

PMSFO118R

1/1

Bone Reposition Forceps, Double Ratchet

Catalog Number	Length (in.)
FOPMS118R	8

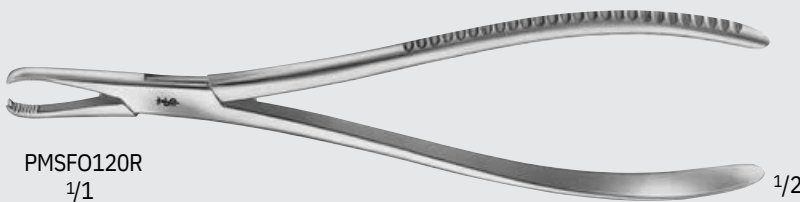

PMSFO120R

1/1

1/2

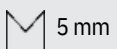

5 mm

PMSFO120R

Bone Holding Forceps

Catalog Number	Length (in.)
PMSFO120R	7 7/8

ORTHO
SPINE

MILLIMETERS

Bone Reduction Forceps

Catalog Number	Length (in.)
PMSFO123R	5 1/2



PMSFO123R

1/2



1/1

PMSFO123R

Bone Reduction Forceps, W/ Screw Lock and Thread Fixation

Catalog Number	Length (in.)
PMSFO124R	6 3/4
PMSFO125R	9 1/4

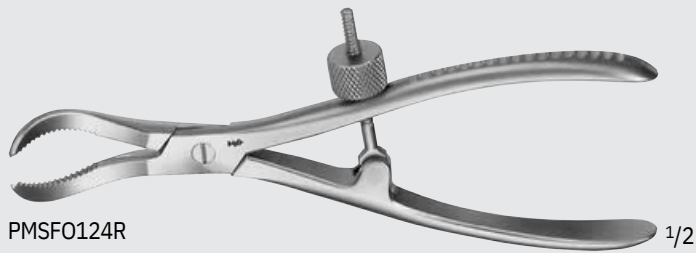

PMSFO124R

1/2



PMSFO125R

1/2

Orthopedics/Spine

Bone Holding Forceps



LANGENBECK Bone Holding Forceps

Catalog Number	Tip Size (mm)	Length (in.)
PMSFO127R	11	8



PMSFO127R



FERGUSSON Bone Holding Forceps

Catalog Number	Tip Size (mm)	Length (in.)
PMSFO130R	12	8



PMSFO130R



SEMB Rib/Bone Holding Forceps

Catalog Number	Tip Size (mm)	Item	Length (in.)
PMSFO135R	8	W/O RATCHET	7 1/2
PMSFO136R	8	W/ RATCHET	7 1/2



ORTHO
SPINE

FARABEUF Bone Holding Forceps

Catalog Number	Tip Size (mm)	Length (in.)
PMSFO140R	9	9
PMSFO141R	11	10



PMSFO140R

1/2

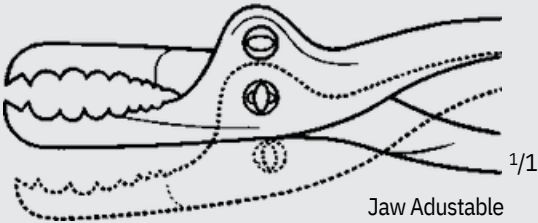

1/1

Jaw Adustable



PMSFO140R



PMSFO141R

1/2



PMSFO141R

FARABEUF-LAMBOTTE Forceps, W/ Ratchet

Catalog Number	Tip Size (mm)	Length (in.)
PMSFO143R	11	10



PMSFO143R

1/2



PMSFO143R



ORTHOSpine

INCHES

Orthopedics/Spine

Bone Holding Forceps



KERN Mini Bone Holding Forceps, W/ Ratchet

Catalog Number	Tip Size (mm)	Length (in.)
PMSFO148R	7.5	6 1/8

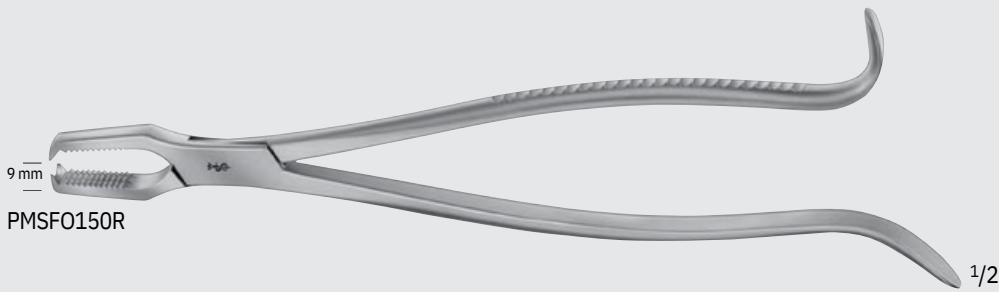

KERN-LANE Bone Holding Forceps

Catalog Number	Tip Size (mm)	Length (in.)
PMSFO150R	9	9 1/2



KERN-LANE Bone Holding Forceps, W/ Ratchet

Catalog Number	Tip Size (mm)	Length (in.)
PMSFO158R	9	9 1/2



LANE Bone Holding Forceps

Catalog Number	Tip Size (mm)	Description	Length (in.)
PMSFO151R	9	W/O RATCHET	13
PMSFO159R	13	W/ RATCHET	12 1/2

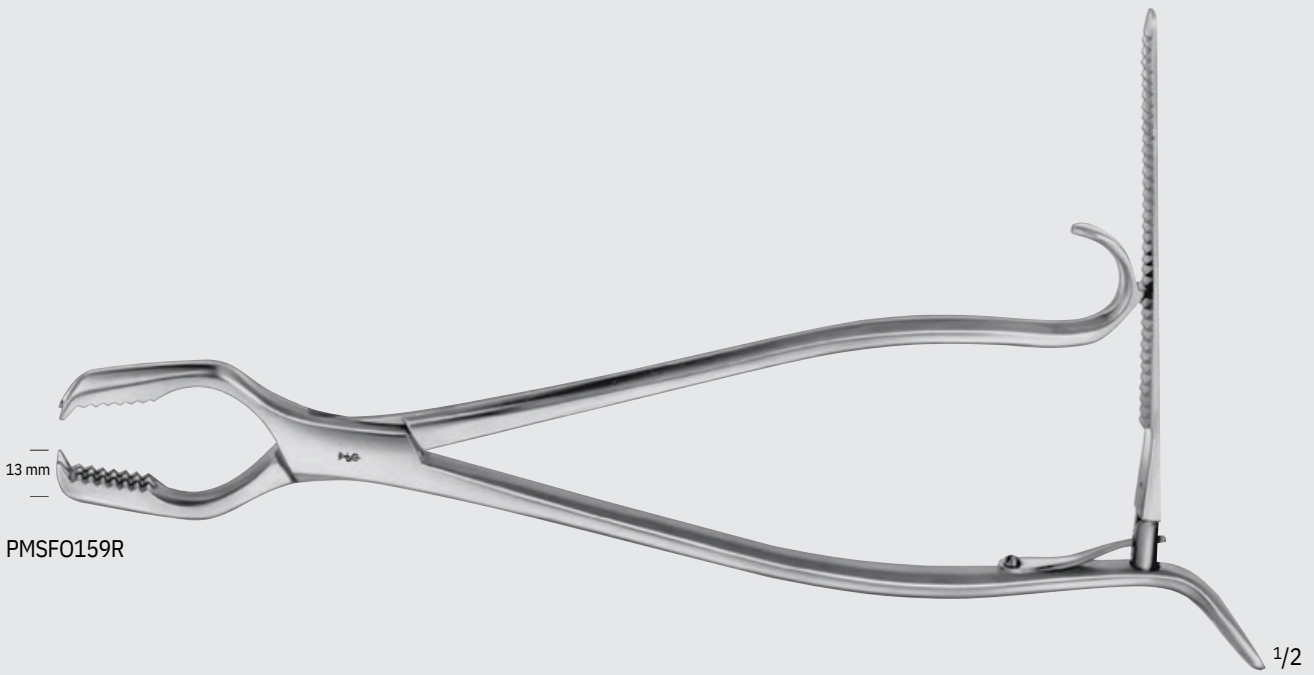
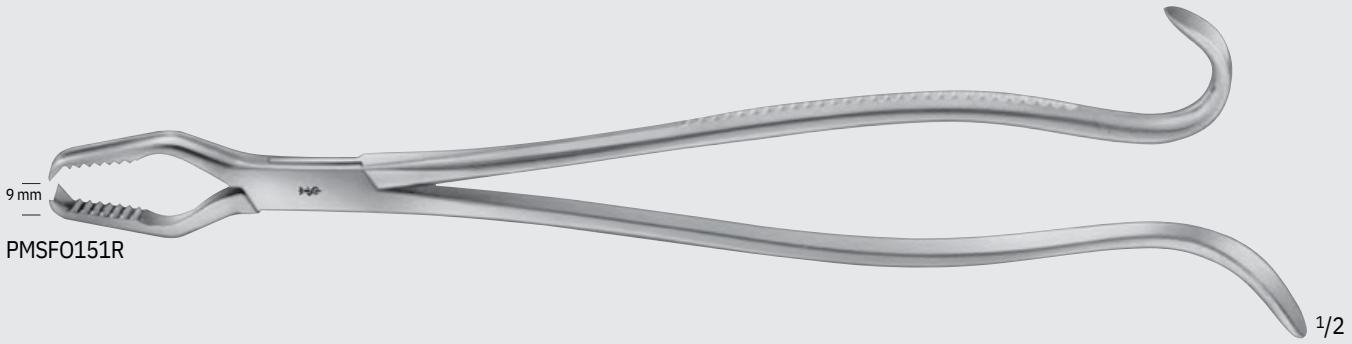

Orthopedics/Spine

Bone Holding Forceps



PMSFO153R

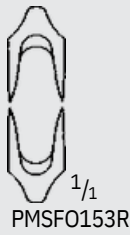

PMSFO153R

Patella Forceps W/ Screw Lock

Catalog Number	Length (in.)
PMSFO153R	7 1/4

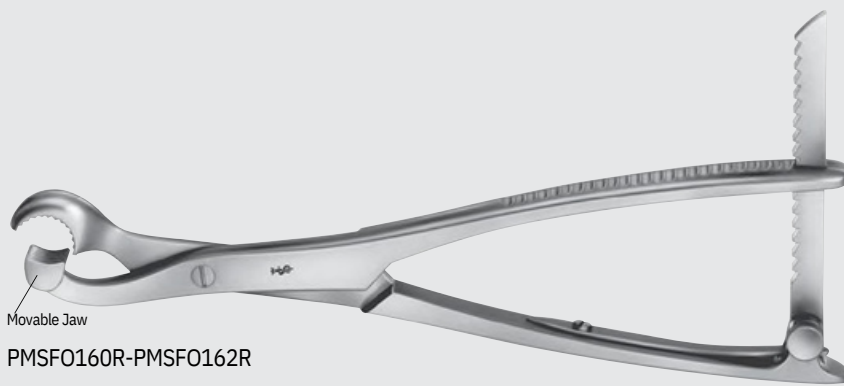

PMSFO160R-PMSFO162R



PMSFO160R



PMSFO161R



PMSFO162R

LAMBOTTE Bone Holding Forceps, W/ Movable Jaw and Ratchet

Catalog Number	Tip Size (mm)	Length (in.)
PMSFO160R	10	8 3/4
PMSFO161R	13	10 1/4
PMSFO162R	16	13

ORTHO
SPINE

MILLIMETERS

Self-Centering Forceps, W/ Screw Lock and Thread Fixation

Catalog Number	Tip Size (mm)	Length (in.)
PMSFO169R	3/3	5 3/4
PMSFO170R	7 / 2.5	7 1/2
PMSFO171R	10.5 / 3.5	9 1/2
PMSFO172R	11 / 3.5	10 1/4
PMSFO173R	11.5 / 4.5	10 3/4



PMSFO169R-PMSFO173R



PMSFO169R



PMSFO170R

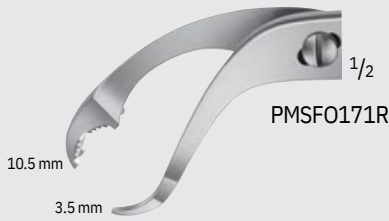

PMSFO171R



PMSFO172R

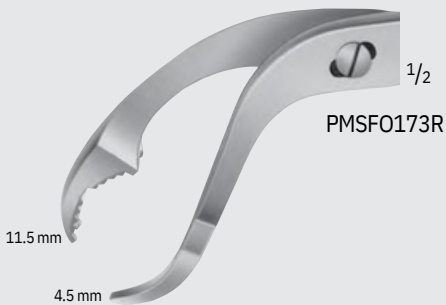

PMSFO173R

Orthopedics/Spine

Bone Holding Forceps

VERBRUGGE Bone Forceps

Catalog Number	Tip Size (mm)	Length (in.)
PMSFO180R	5	6 7/8
PMSFO181R	10 / 4.0	9 3/4
PMSFO182R	11 / 4.5	10 1/2
PMSFO183R	12 / 4.5	10 5/8

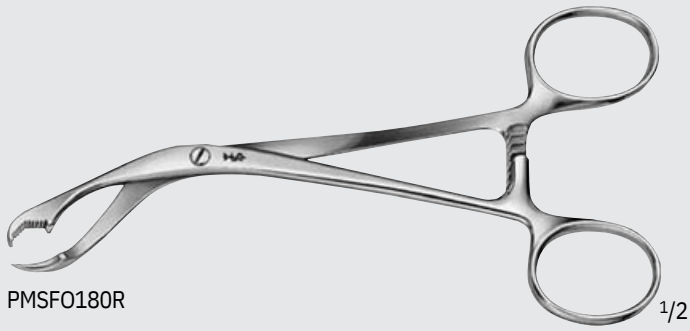

PMSFO180R

1/2



5 mm

PMSFO180R

1/2

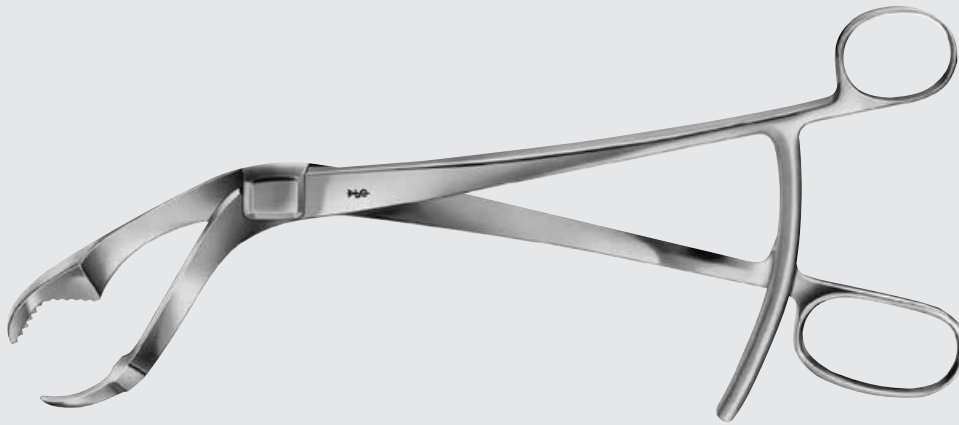

PMSFO181R-PMSFO183R



10 mm

4 mm

PMSFO181R

1/2

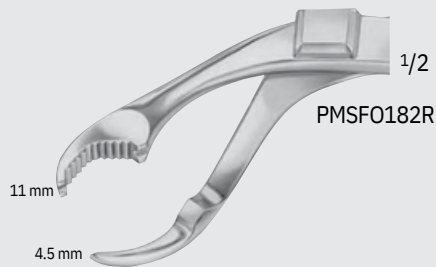

11 mm

4.5 mm

PMSFO182R

1/2

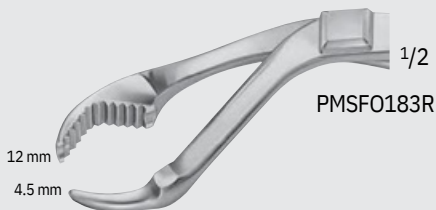

12 mm

4.5 mm

PMSFO183R

1/2





PMSFO190R-PMSFO191R

LOWMAN Bone Clamp

Catalog Number	Length (in.)
PMSFO190R	6 7/8
PMSFO191R	8



PMSFO192R

LOWMAN-GERSTER Bone Clamp

Catalog Number	Length (in.)
PMSFO192R	8 1/4



PMSFO193R

LOWMAN-HOGLUND Bone Clamp

Catalog Number	Length (in.)
PMSFO193R	6 7/8

Orthopedics/Spine

Bone Holding Forceps

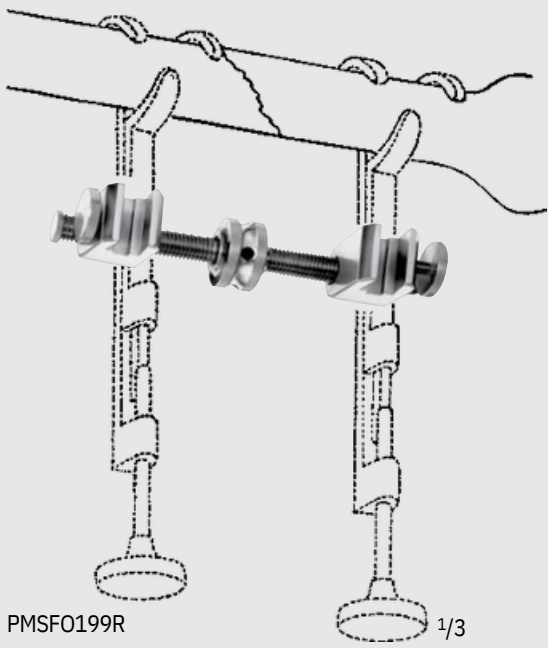

**GERSTER Traction Bar
F/FO190R-FO193R**

Catalog Number
PMSFO199R

PMSFO199R

1/3

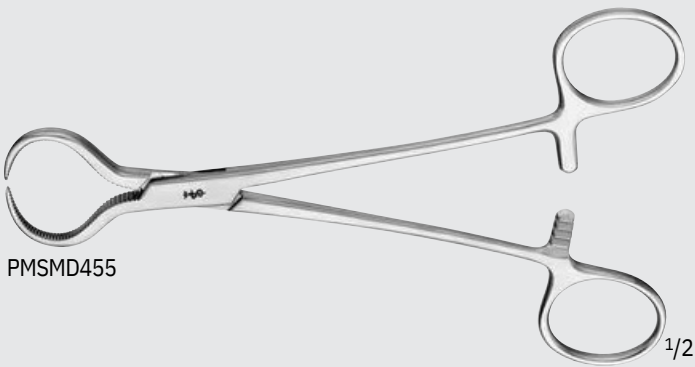

LEWIN Bone Clamp

Catalog Number	Tip	Length (in.)
PMSMD455	SERR	7

PMSMD455

1/2

ORTHO
SPINE

MILLIMETERS



Dimensions for blade size of retractors
 1st number = depth Example: 25 x 38 mm
 2nd number = width



PMSBT419R

Knee Retractor

Catalog Number	Blade Size (mm)	Length (in.)
PMSBT419R	39 x 9	8 7/8

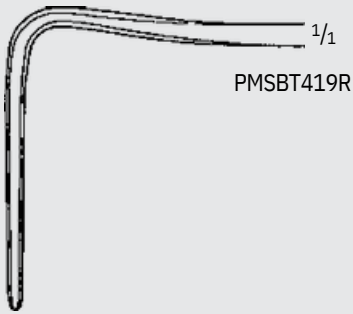

PMSBT419R

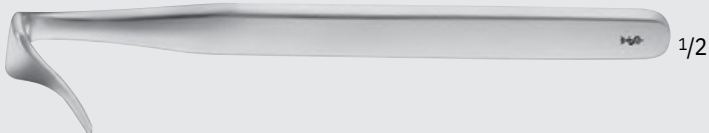

PMSBT420R

BLOUNT Knee Retractor

Catalog Number	Blade Size (mm)	Length (in.)
PMSBT420R	40 x 4	6 7/8

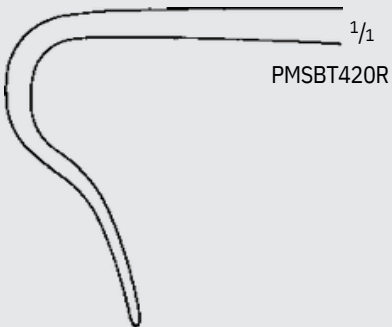

PMSBT420R



Orthopedics/Spine

Retractors



PMSBT430R

Knee Retractor

Catalog Number	Blade Size (mm)	Length (in.)
PMSBT430R	56 x 10	6 3/4

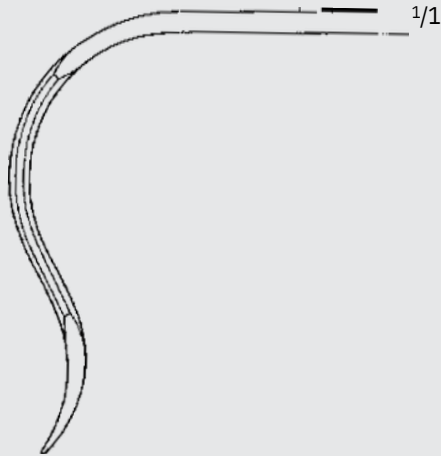

PMSBT430R



PMSMB976R

DOANE "Z" Knee Retractor

Catalog Number	Blade Size (mm)	Size
PMSMB976R	55 x 75	MEDIUM
PMSMB977R	66 x 80	LARGE



PMSMB977R



T-Handle Retractor

Catalog Number	Blade Size (mm)	Length (in.)
PMSMD512R	120 x 32	7
PMSMD513R	120 x 32	11
PMSMD514R	120 x 32	13

PMSMD512R-PMSMD514R



HIBBS Retractor

Catalog Number	Blade Size (mm)	Length (in.)
PMSBT503R	25 x 75	9 1/8
PMSBT504R	20 x 50	9 1/8
PMSBT505R	13 x 25	9 1/8

PMSBT503R-PMSBT505R



PMSBT503R



PMSBT504R



PMSBT505R



ORTHO
SPINE

INCHES

Orthopedics/Spine

Retractors



PMSBT501R-PMSBT502R



1/1

PMSBT501R



1/1

PMSBT502R

TAYLOR Spinal Retractor

Catalog Number	Blade Size (mm)	Length (in.)
PMSBT501R	30 x 70	7 1/4
PMSBT502R	30 x 100	7 7/8





PMSBT421R-PMSBT425R

SMILLIE Retractor

Catalog Number	Blade Size (mm)	Length (in.)
PMSBT421R	32 x 19	5 1/2
PMSBT422R	48 x 19	5 1/2
PMSBT423R	57 x 19	5 1/2
PMSBT424R	52 x 13	5 1/2
PMSBT425R	12 x 13	5 1/2

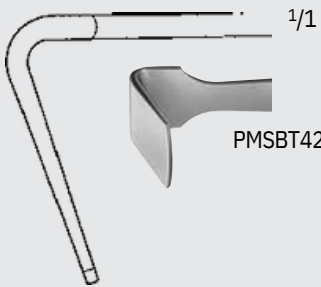

PMSBT421R

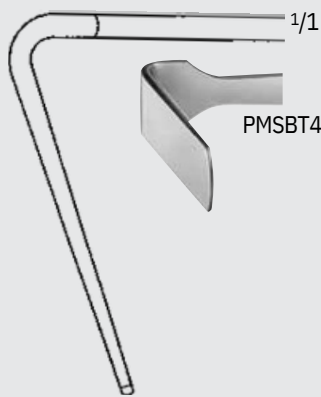

PMSBT422R

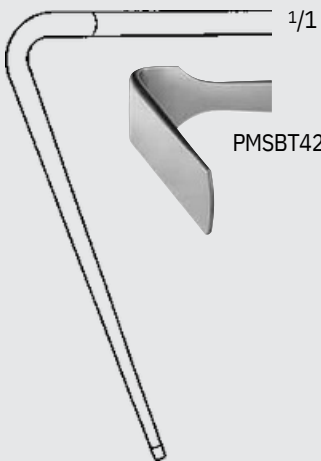

PMSBT423R

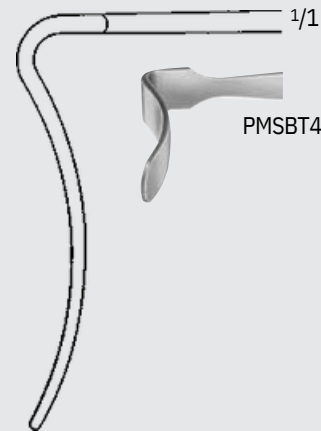

PMSBT424R

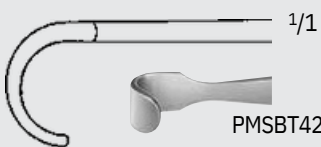

PMSBT425R



ORTHO
SPINE

Orthopedics/Spine

Retractors

MEYERDING Retractor

Catalog Number	Blade Size (mm)	Length (in.)
PMSBT485R	52 x 16	9
PMSBT486R	76 x 25	9
PMSBT487R	89 x 50	10

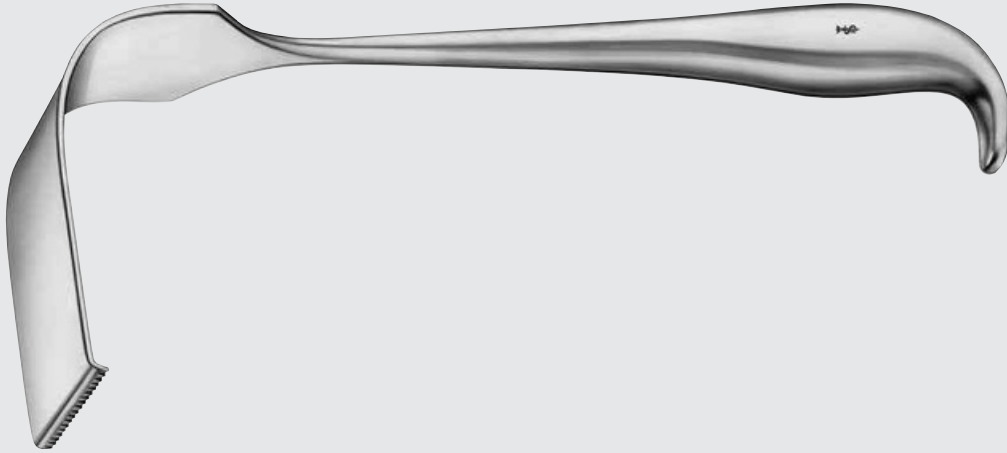

PMSBT485R-PMSBT487R

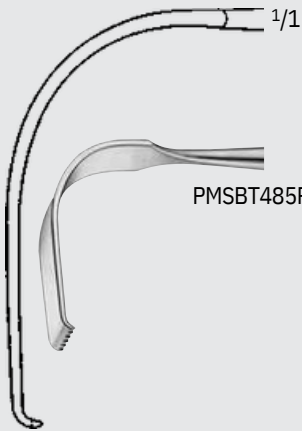

PMSBT485R

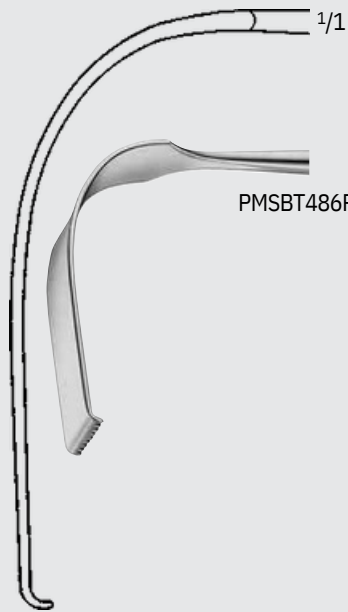

PMSBT486R

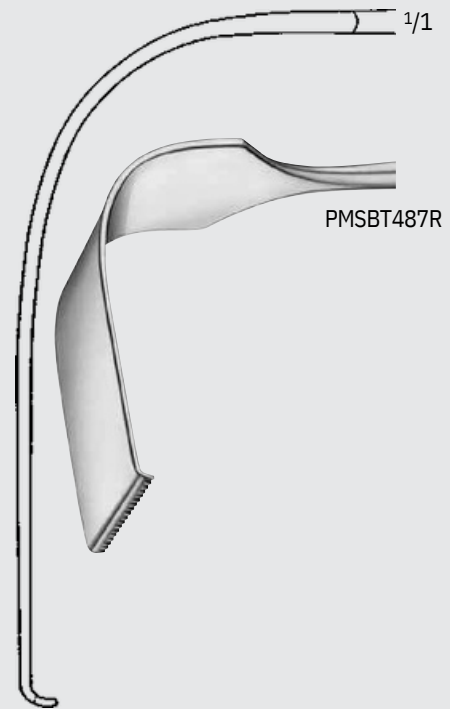

PMSBT487R

ORTHO
SPINE

MILLIMETERS

AUFRANC Cobra Retractor

Catalog Number	Tip	Length (in.)
PMSMB448R	SMOOTH, POINTED	10
PMSMB514R	SMOOTH, BLUNT	10

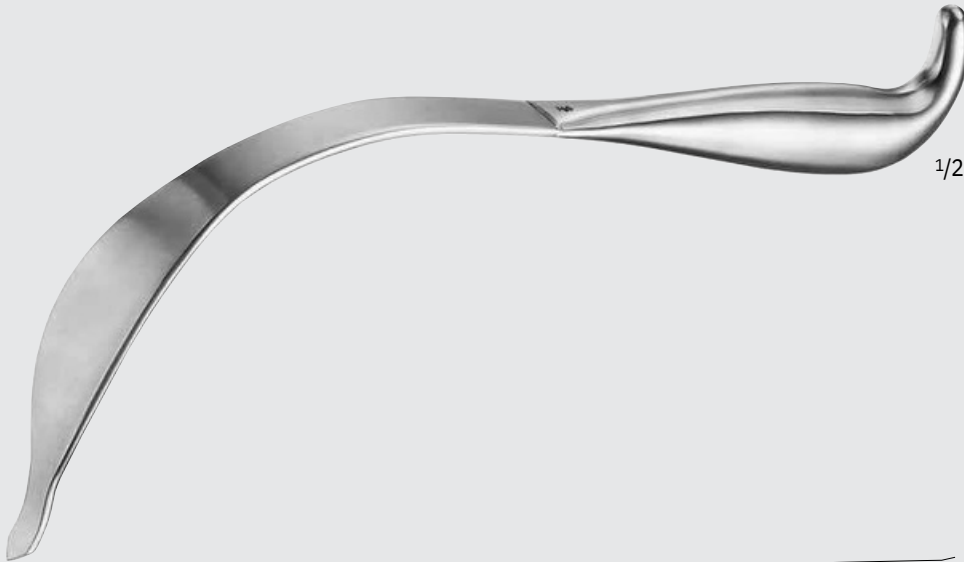

1/2

PMSMB448R-PMSMB514R

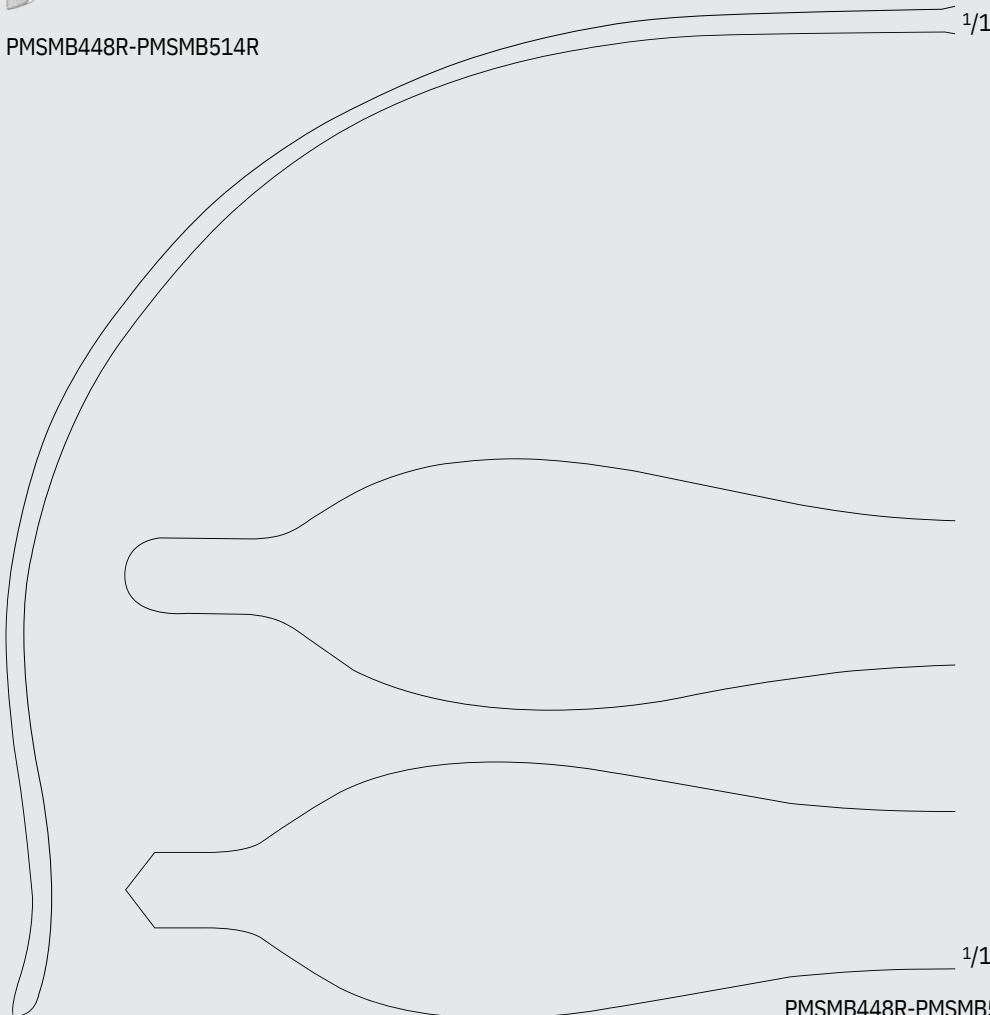

1/1

1/1

PMSMB448R-PMSMB514R



Orthopedics/Spine

Retractors

AUFRANC Cobra Retractor

Catalog Number	Tip	Length (in.)
PMSMB379R	SERR, BLUNT	10

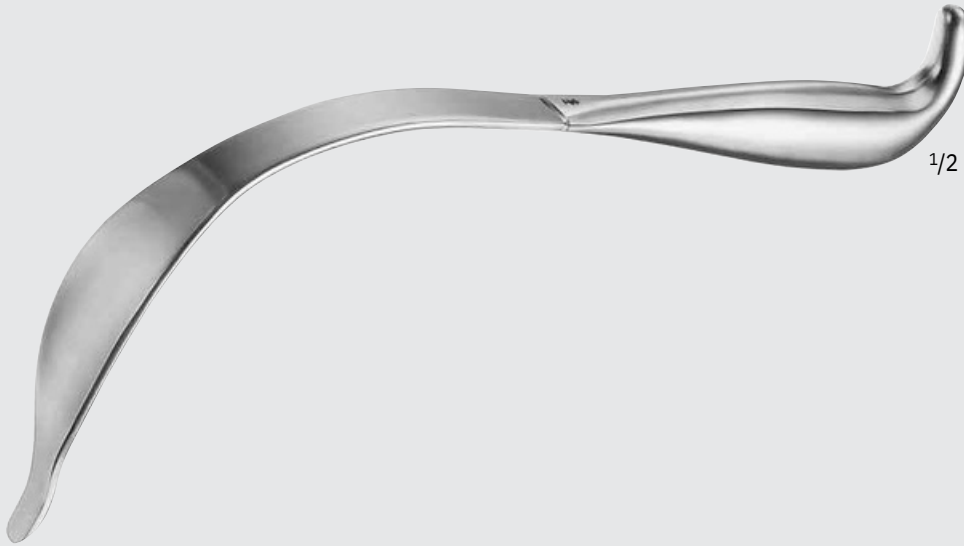

1/2

PMSMB379R

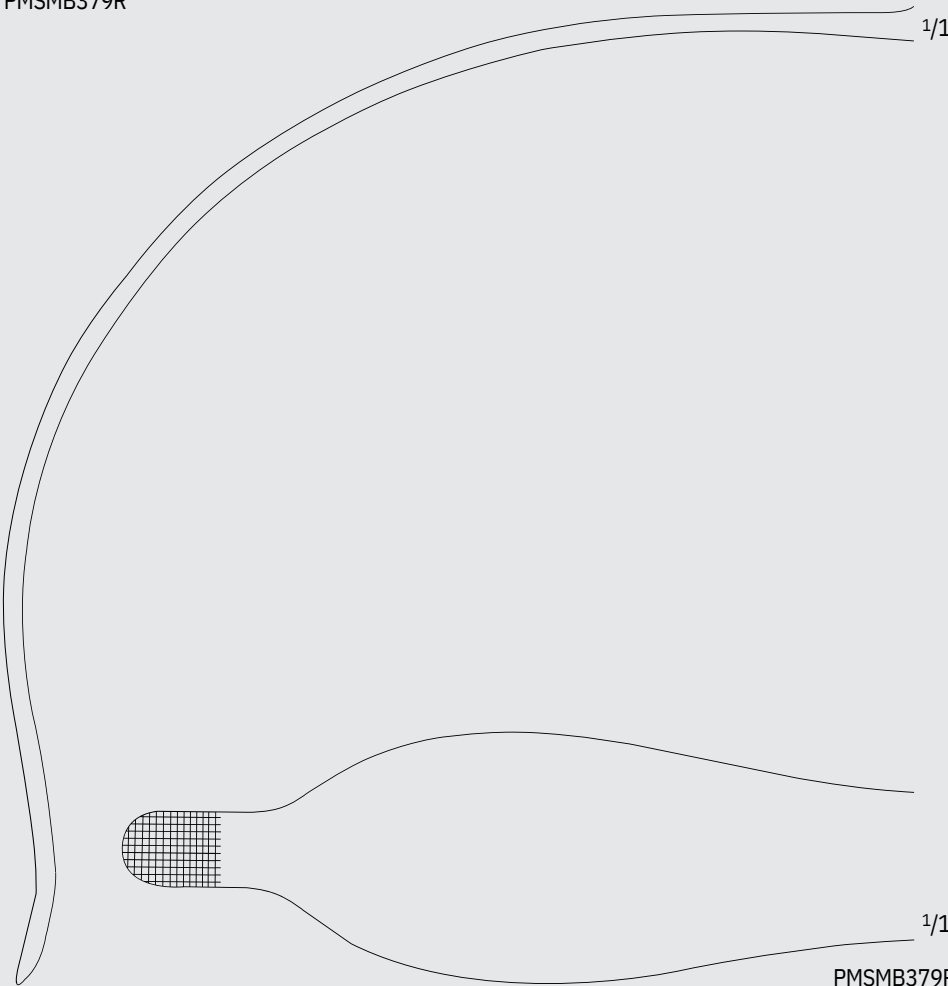

1/1

1/1

PMSMB379R





PMSMF058R-PMSMF060R

**CLOWARD Style Cervical Retractor
W/ Lip**

Catalog Number	Width (mm)	Length (in.)
PMSMF058R	18	7
PMSMF059R	20	7
PMSMF060R	23	7

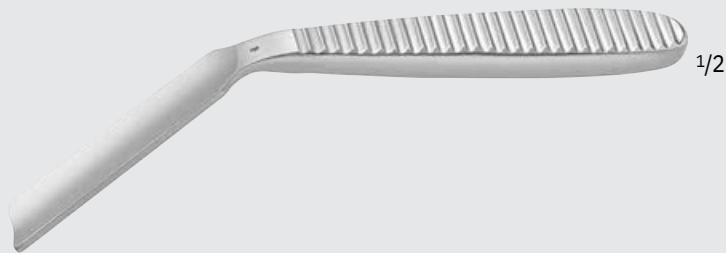

PMSMN073R-PMSMN075R

**CLOWARD Style Cervical Retractor
W/O Lip**

Catalog Number	Width (mm)	Length (in.)
PMSMN073R	18	7
PMSMN074R	20	7
PMSMN075R	23	7



Orthopedics/Spine

Retractors

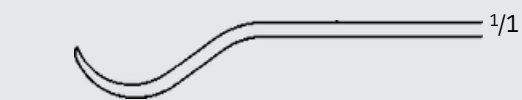
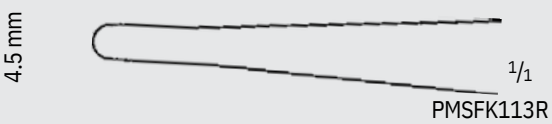
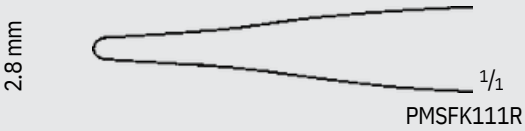
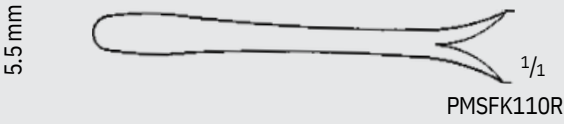
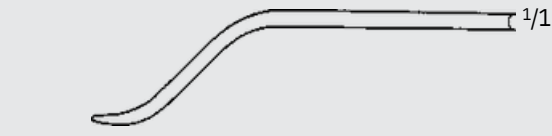

HAYES Bone Retractor

Catalog Number	Blade Size (mm)	Length (in.)
PMSFK110R	5.5	6 1/8
PMSFK111R	2.8	5 1/2
PMSFK113R	4.5	6
PMSFK114R	7	6

BUCK-GRAMCKO Bone Retractor

Catalog Number	Blade Size (mm)	Length (in.)
PMSFK116R	2/7.5	6

HOHMANN Bone Retractor

Catalog Number	Blade Size (mm)	Length (in.)
PMSFK117R	2/6	6 1/4
PMSFK118R	2/8	6 1/4
PMSMB449R	2/15	6

Baby HOHMANN Retractor

Catalog Number	Blade Size (mm)	Length (in.)
PMSFK119R	2/15	5



ORTHO SPINE

INCHES

Orthopedics/Spine

Retractors



PMSFK170R

HOHMANN Bone Retractor

Catalog Number	Blade Size (mm)	Length (in.)
PMSFK170R	9	8 3/4
PMSFK166R	17	9 1/2

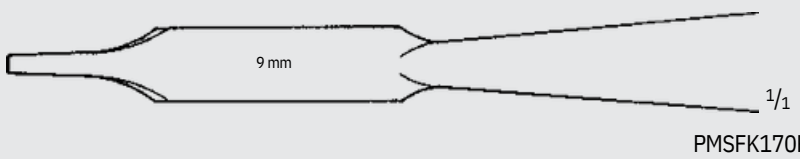
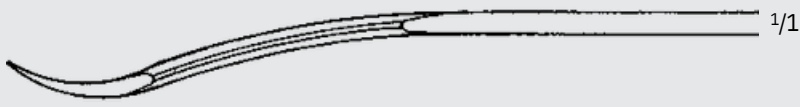

PMSFK170R



PMSFK166R

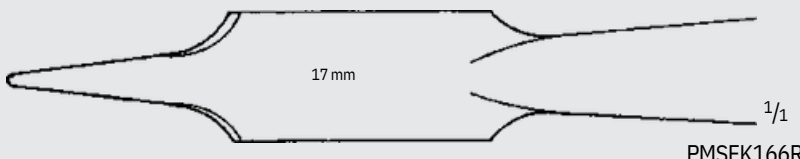

PMSFK166R

HOHMANN Bone Retractor (continued)

Catalog Number	Blade Size (mm)	Length (in.)
PMSFK171R	18	9 1/2
PMSFK176R	25	10 5/8

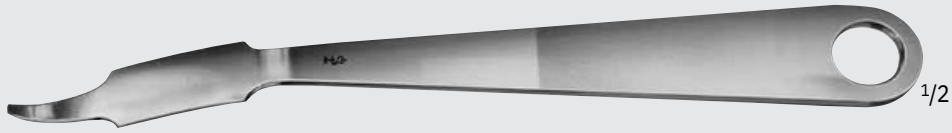

PMSFK171R

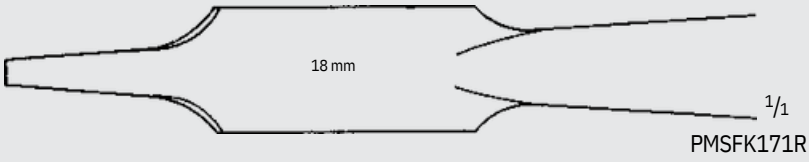
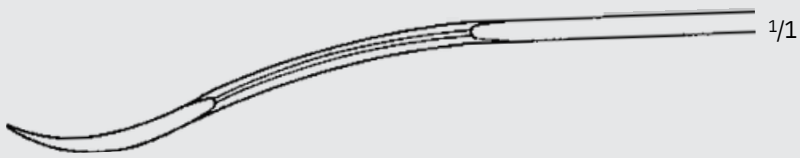

PMSFK176R

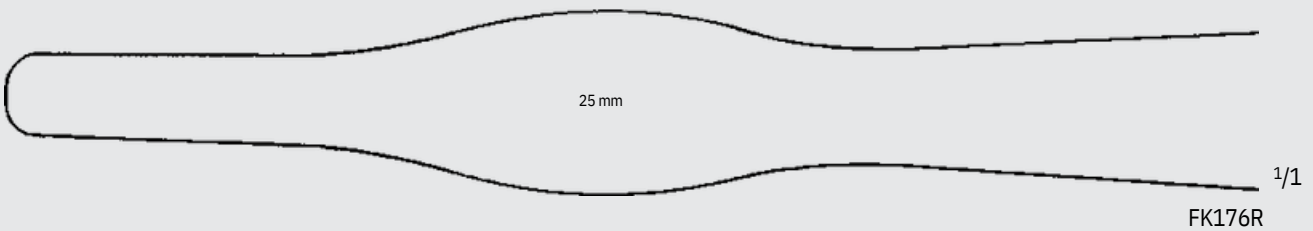

Orthopedics/Spine

Retractors

HOHMANN Bone Retractor (continued)

Catalog Number	Blade Size (mm)	Length (in.)
PMSFK172R	24	10 1/4
PMSFK173R	34	11 1/4



PMSFK172R-PMSFK173R

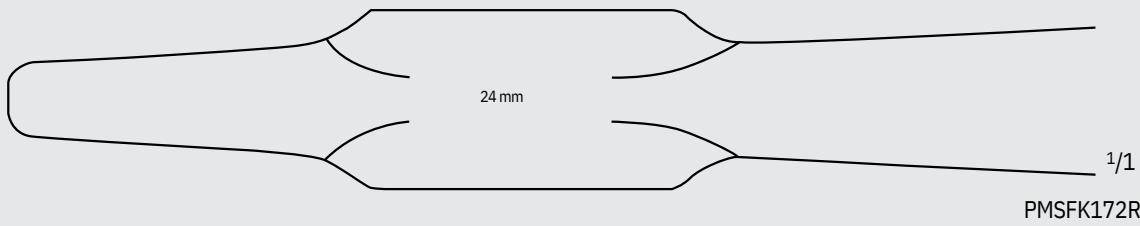
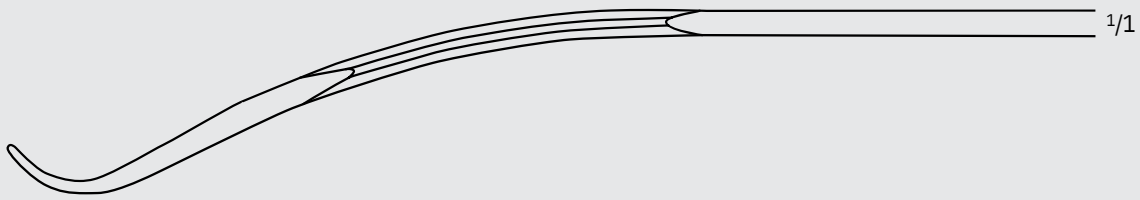

PMSFK172R

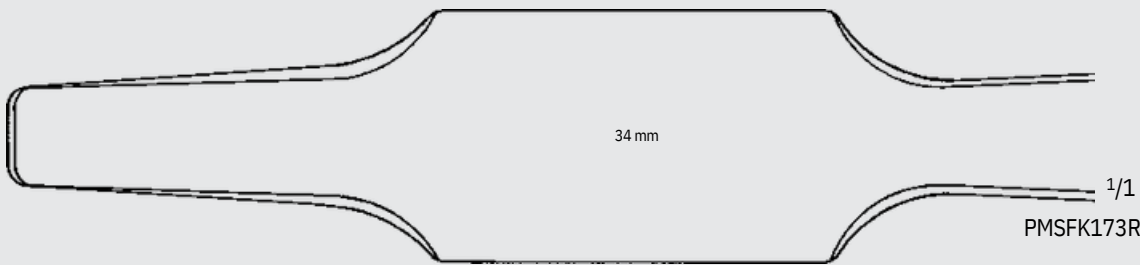
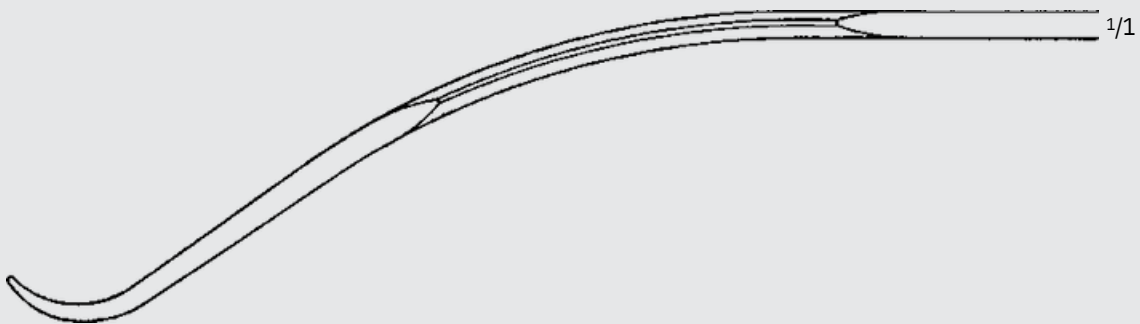

PMSFK173R



LANGE-HOHMANN Bone Retractor

Catalog Number	Blade Size (mm)	Length (in.)
PMSFK160R	24	9 3/4



PMSFK160R

1/2



1/1

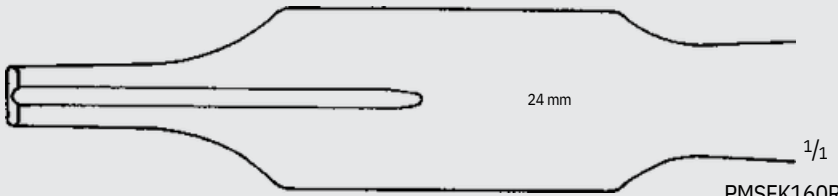

24 mm

1/1

PMSFK160R



ORTHO
SPINE

INCHES

Orthopedics/Spine

Retractors

LANGE-HOHMANN Bone Retractor (continued)

Catalog Number	Blade Size (mm)	Length (in.)
PMSFK161R	30	10 1/2
PMSFK162R	33	11



PMSFK161R-PMSFK162R

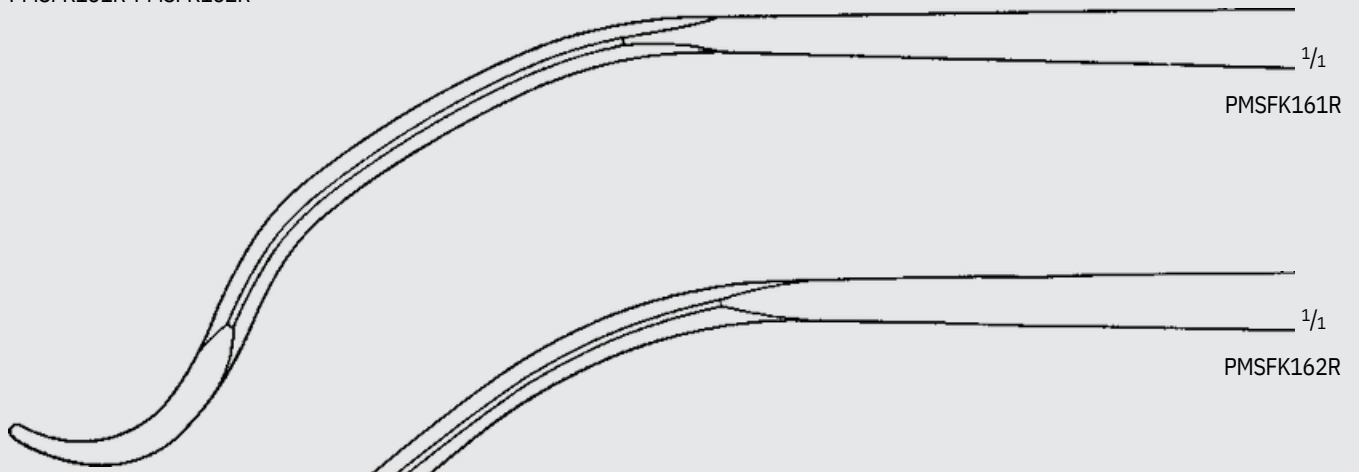

PMSFK161R

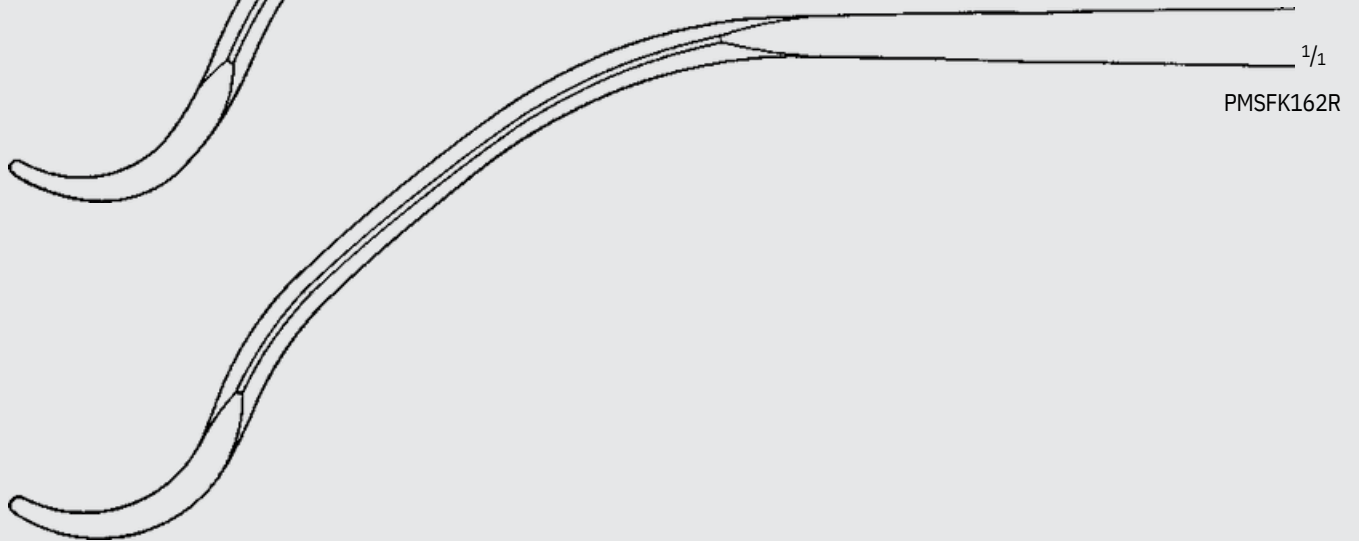

PMSFK162R

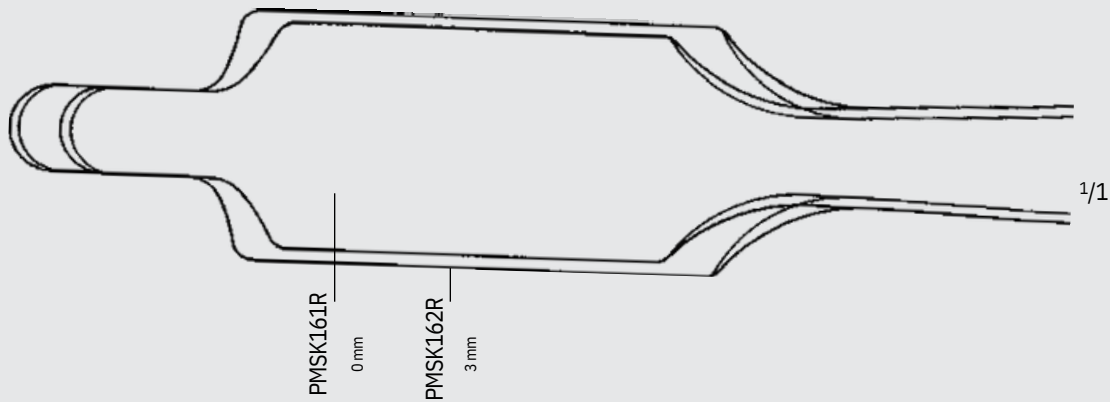

PMSK161R
0 mm

PMSK162R
3 mm





PMSFK167R

1/2

HOHMANN (WAGNER) Humoral Head Retractor

Catalog Number	Blade Size (mm)	Length (in.)
PMSFK167R	17	8 3/4

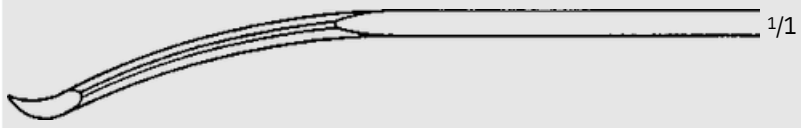

1/1

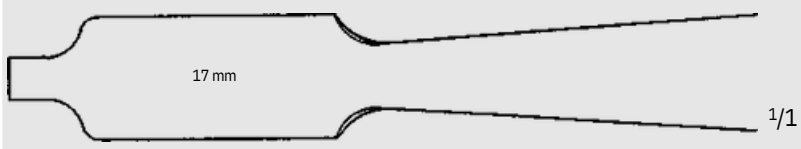

17 mm

1/1

PMSFK167R



PMSFK169R

1/2

HOHMANN (ALDINGER) Bone Retractor

Catalog Number	Blade Size (mm)	Length (in.)
PMSFK169R	24	10 5/8



1/1

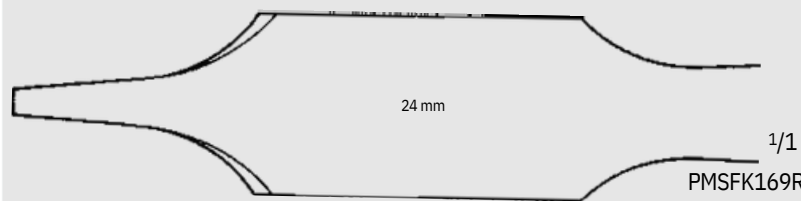

24 mm

1/1

PMSFK169R

ORTHO
SPINE

INCHES

Orthopedics/Spine

Retractors



PMSFK185R-PMSFK187R

HOHMANN Bone Retractor

Catalog Number	Blade Size (mm)	Length (in.)
PMSFK185R	8	8 3/4
PMSFK186R	15	9 3/4
PMSFK187R	22	11 3/4

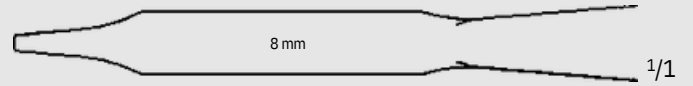

PMSFK185R

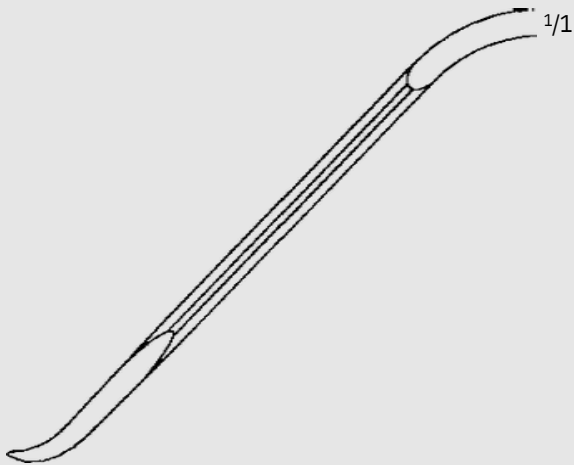

PMSFK186R

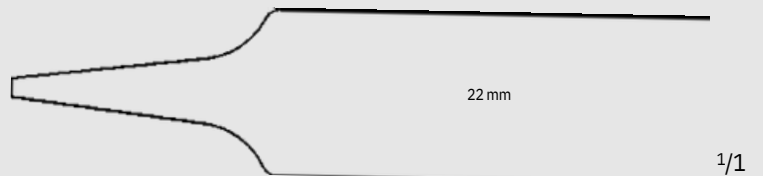
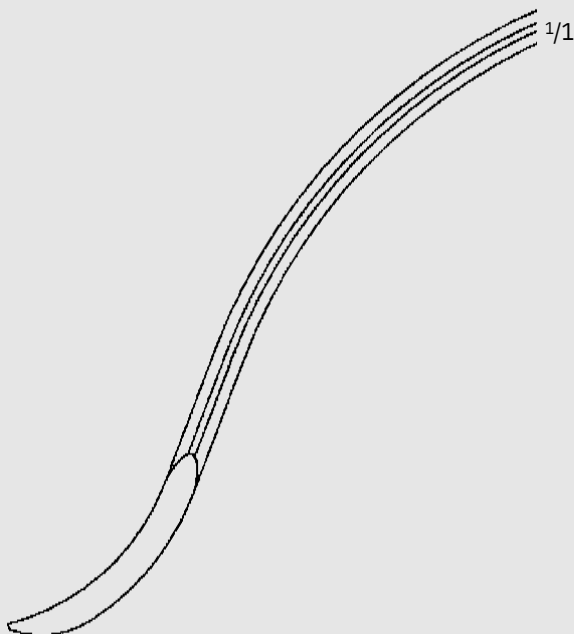

PMSFK187R



HOHMANN Bone Retractor (continued)

Catalog Number	Blade Size (mm)	Length (in.)
PMSFK188R	43	9

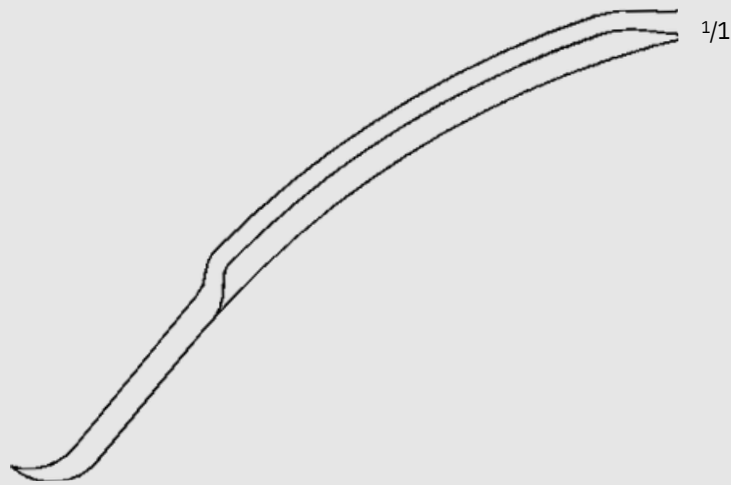

Orthopedics/Spine

Retractors

HOHMANN Bone Retractor (continued)

Catalog Number	Blade Size (mm)	Length (in.)
PMSFK189R	40	11 1/2

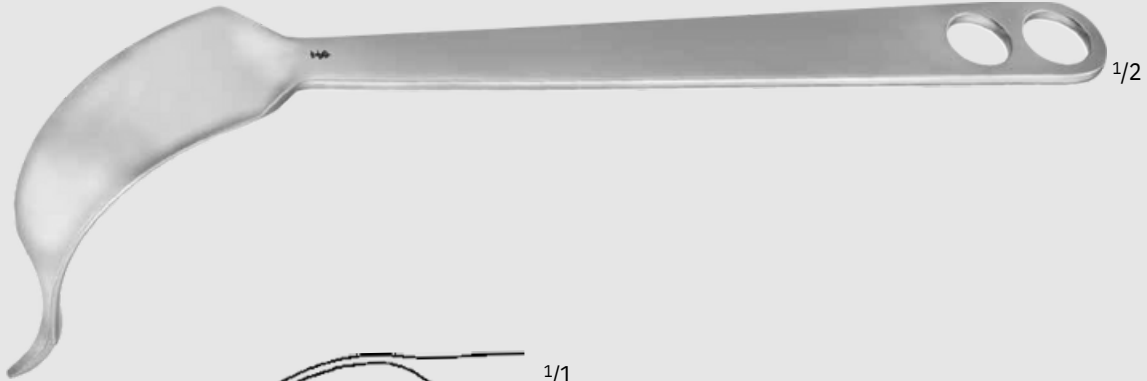

PMSFK189R

1/1

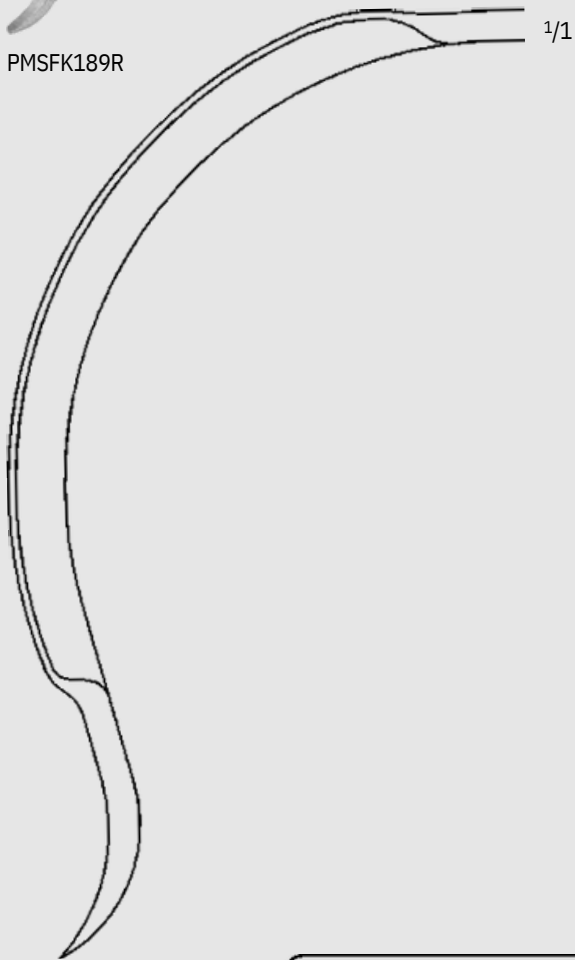

40 mm

1/1

PMSFK189R



**SCHUMACHER Modi ed WAGNER
Bone Retractor**

Catalog Number	Blade Size (mm)	Length (in.)
PMSFK168R	37	14



PMSFK168R

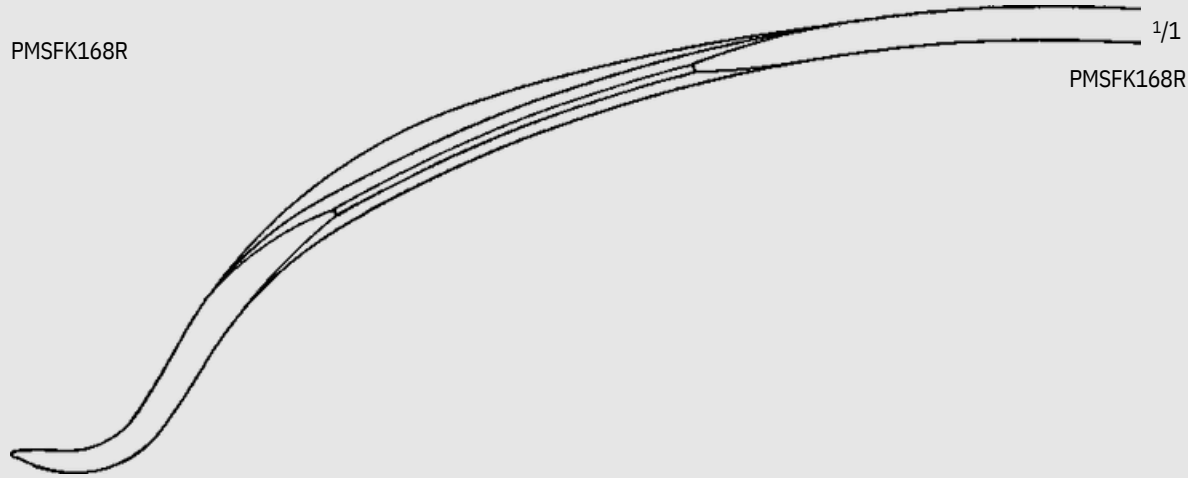

PMSFK168R

SCHUMACHER Bone Retractor

Catalog Number	Blade Size (mm)	Length (in.)
PMSFK177R	35	11 1/2



PMSFK177R

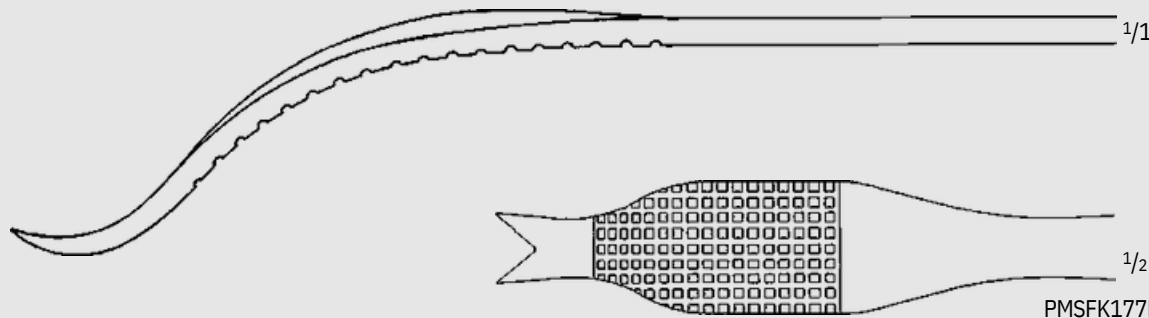

PMSFK177R

Orthopedics/Spine

Retractors

VERBRUGGE-MÜLLER Bone Retractor

Catalog Number	Blade Size (mm)	Length (in.)
PMSFK174R	44	9 1/2
PMSFK175R	65	10



PMSFK174R-PMSFK175R

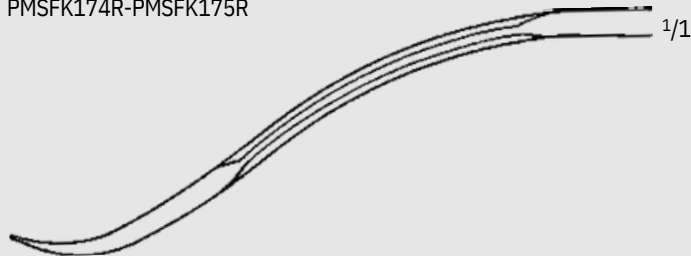

1/1

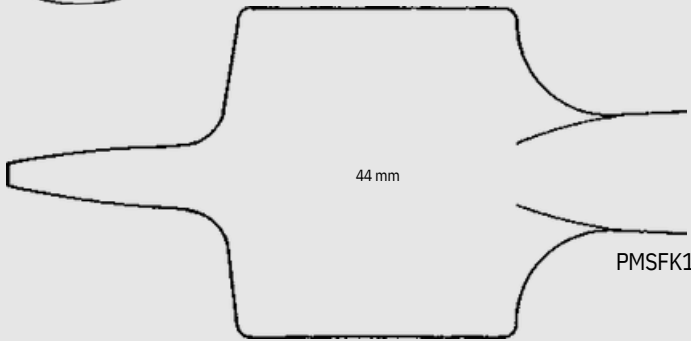

44 mm

1/1
PMSFK174R



1/1

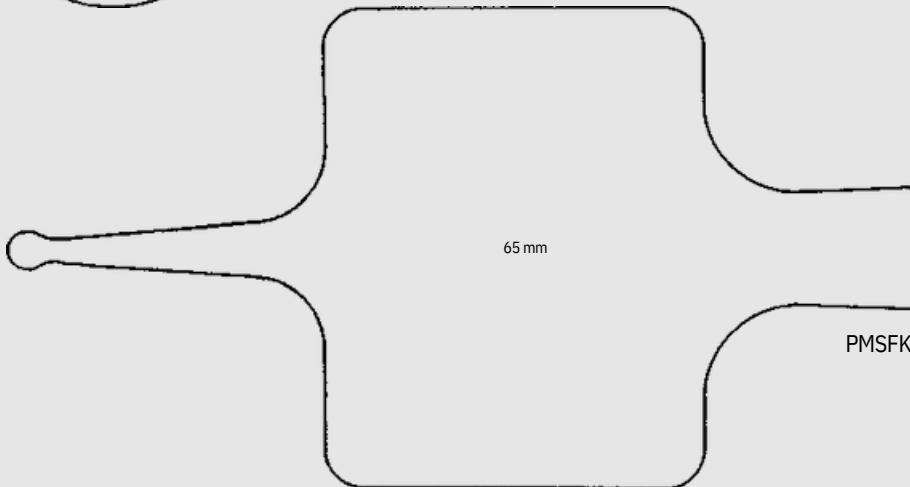

65 mm

1/1
PMSFK175R



MILLIMETERS

BENNETT Bone Retractor

Catalog Number	Blade Size (mm)	Length (in.)
PMSFK180R	65	9 1/2
PMSMD563	44	9 1/2



PMSFK180R, PMSMD563

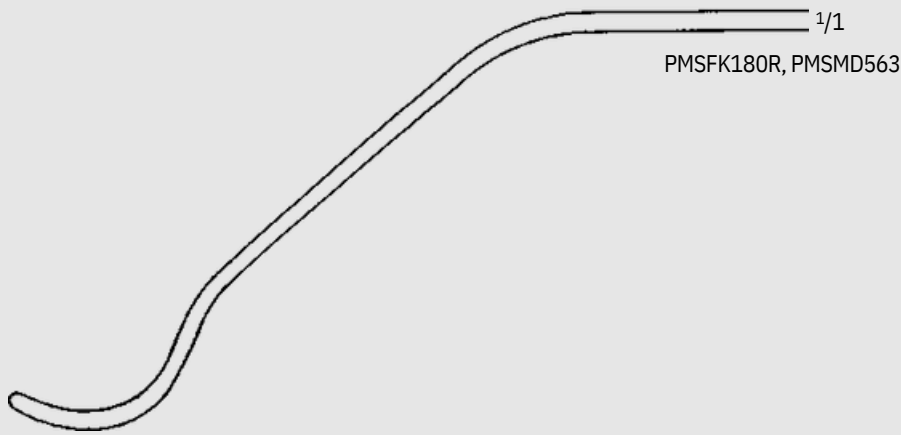

MURPHY-LANE Bone Skid

Catalog Number	Blade Size (mm)	Length (in.)
PMSFK193R	18 / 30	11 3/4



PMSFK193R



Orthopedics/Spine

Retractors

Bone Hook

Catalog Number	Tip	Blade End	Length (in.)
PMSBT232R	SHARP	1 PRONG	9 5/8



PMSBT232R

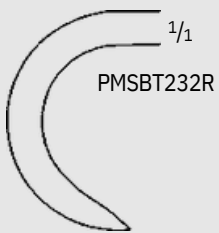

PMSBT232R

KOCHER Bone Hook

Catalog Number	Tip	Blade End	Length (in.)
PMSBT234R	SHARP	1 PRONG	8
PMSBT238R	SHARP	1 PRONG	8 3/4
PMSBT239R	BLUNT	1 PRONG	8 3/4



PMSBT234R

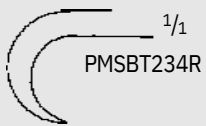

PMSBT234R



PMSBT238R

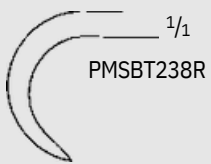

PMSBT238R



PMSBT239R



PMSBT239R





PMSBT240R

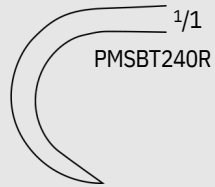

PMSBT240R



PMSBT241R

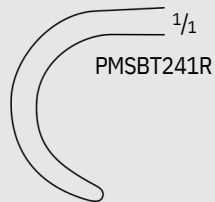

PMSBT241R

VOLKMANN Bone Hook

Catalog Number	Tip	Blade End	Length (in.)
PMSBT240R	SHARP	1 PRONG	8 3/4
PMSBT241R	BLUNT	1 PRONG	8 3/4

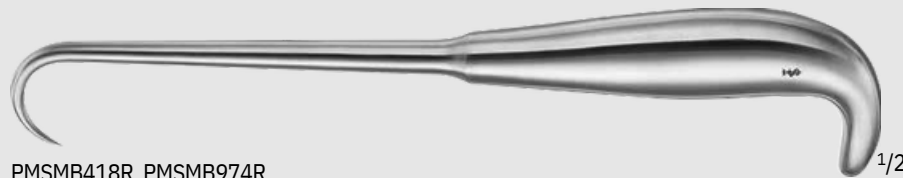

PMSMB418R, PMSMB974R

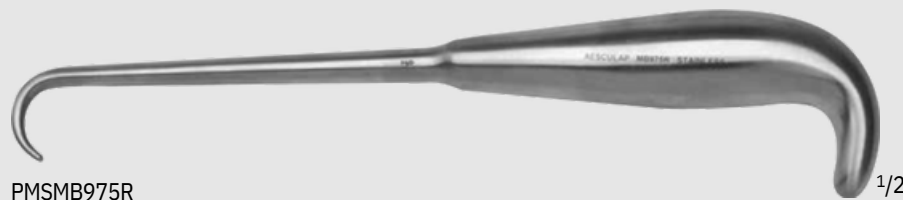

PMSMB975R



PMSMB975R

Bone Hooks

Catalog Number	Tip	Diameter (mm)	Length (in.)
PMSMB974R	SHAR	19	9
PMSMB975R	P	19	9
PMSMB418R	BLUNT	30	9

SHAR
P



Orthopedics/Spine

Retractors

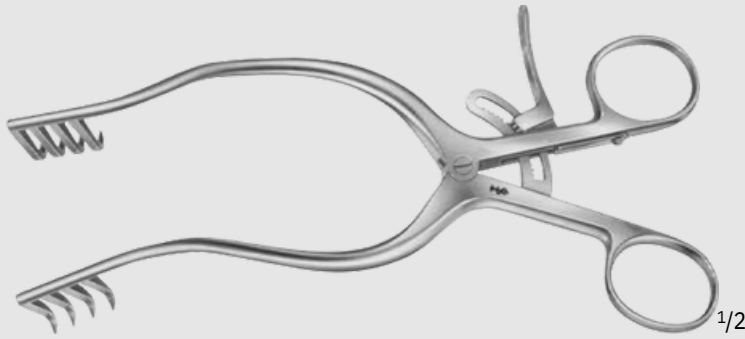

PMSBV250R

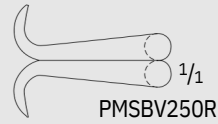

ANDERSON-ADSON Retractor

Catalog Number	Tip	Blade End	Length (in.)
PMSBV250R	SHARP	4 x 4 PRONGS	7 1/2



PMSBV248R



NORFOLK-NORWICH Retractor

Catalog Number	Tip	Blade End	Length (in.)
PMSBV248R	BLUNT	4 x 5 PRONGS	8 3/4

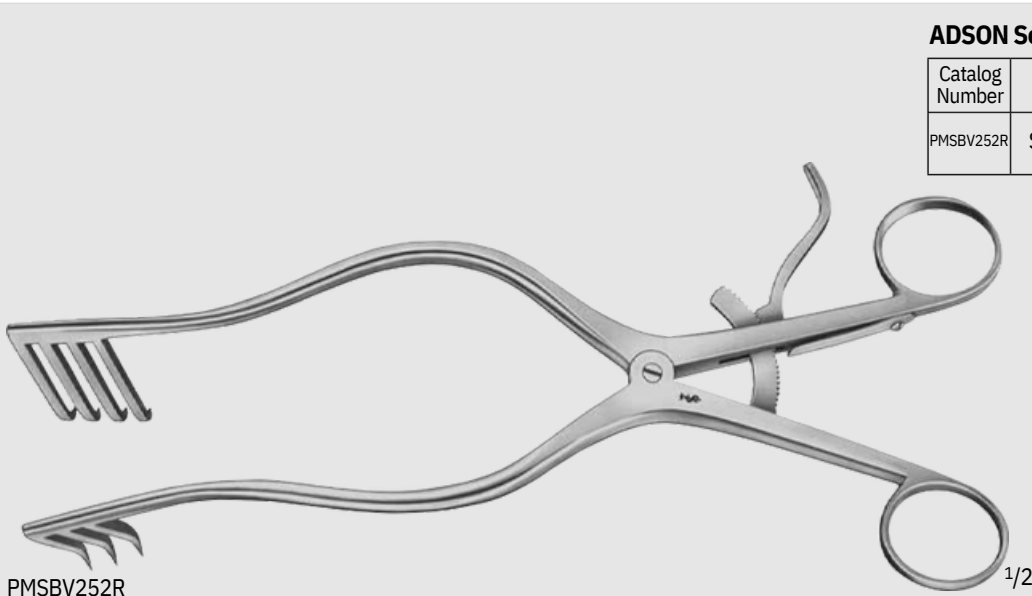

PMSBV252R

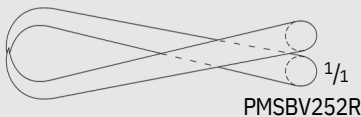

ADSON Self Retaining Retractor

Catalog Number	Tip	Blade End	Length (in.)
PMSBV252R	SHARP	3 x 4 PRONGS	10 1/2

Laminectomy Self Retaining Retractor

Catalog Number	Tip	Blade End	Length (in.)
PMSBV254R	SHARP	6 x 6 PRONGS	11



PMSBV254R

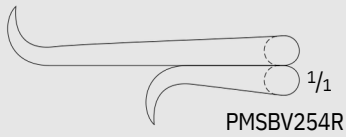

PMSBV254R

ADSON Self Retaining Retractor, Hinged

Catalog Number	Tip	Blade End	Length (in.)
PMSBV251R	SEMI-S	4 x 4 PRONGS	8 1/2



PMSBV251R

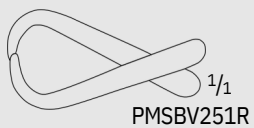

PMSBV251R

Orthopedics/Spine

Retractors

HARVEY-JACKSON Retractor, Hinged

Catalog Number	Tip	Blade End	Length (in.)
PMSBV258R	SHARP	3 x 3 PRONGS	11 3/4

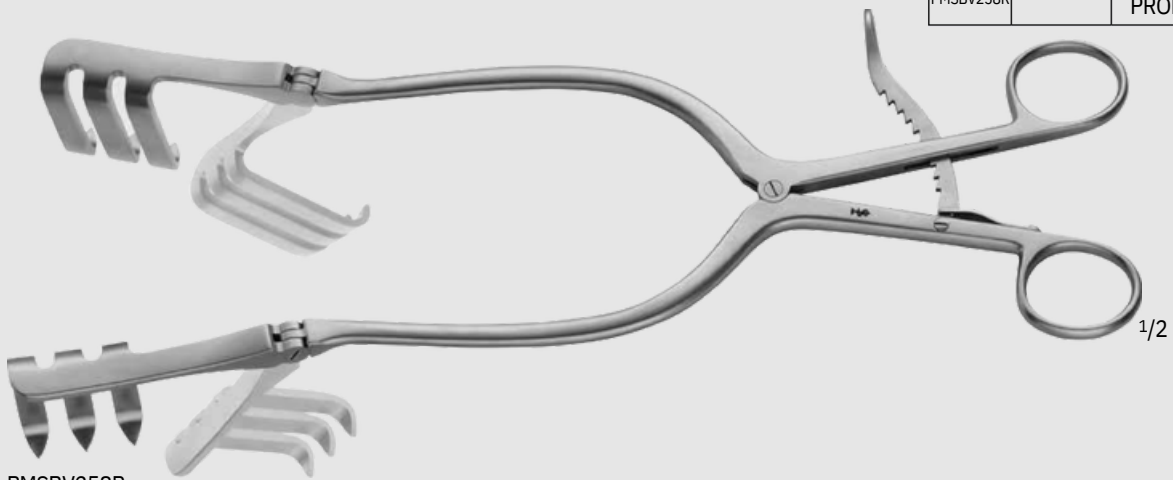

PMSBV258R

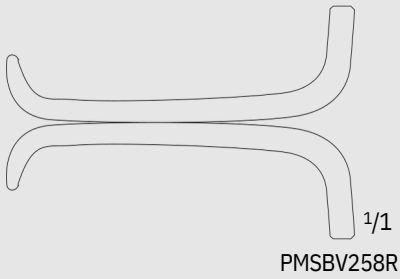

PMSBV258R

BECKMANN-ADSON Retractor, Hinged

Catalog Number	Tip	Blade End	Length (in.)
PMSBV271R	SEMI-S	4 x 4 PRONGS	12 1/4
PMSBV272R	SHARP	4 x 4 PRONGS	12 1/4

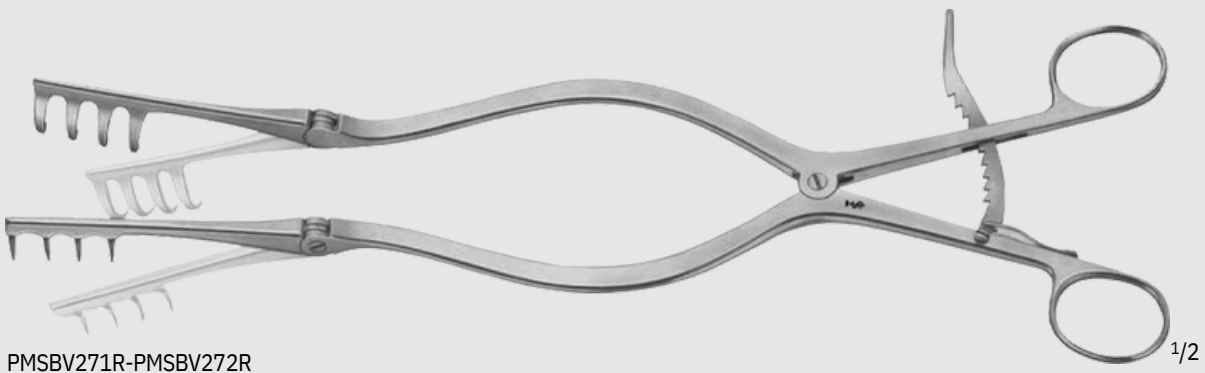

PMSBV271R-PMSBV272R

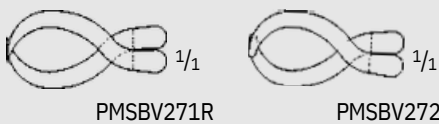

PMSBV271R

PMSBV272R



ADSON Retractor, Hinged

Catalog Number	Tip	Blade End	Length (in.)
PMSBV273R	SEMI-S	5 x 4 PRONGS	12 1/2

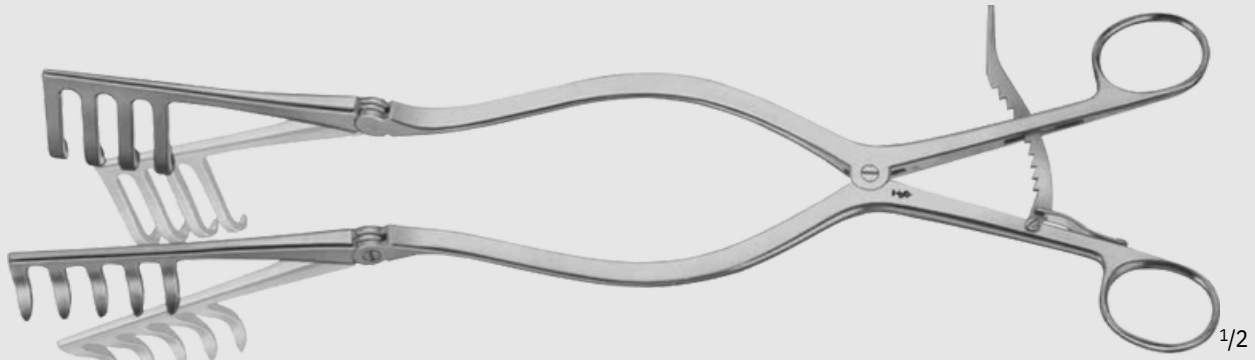

PMSBV273R

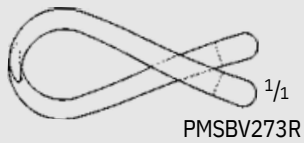

BECKMANN Retractor, Hinged

Catalog Number	Tip	Blade End	Length (in.)
PMSBV276R	SHARP	7 x 7 PRONGS	12 1/2

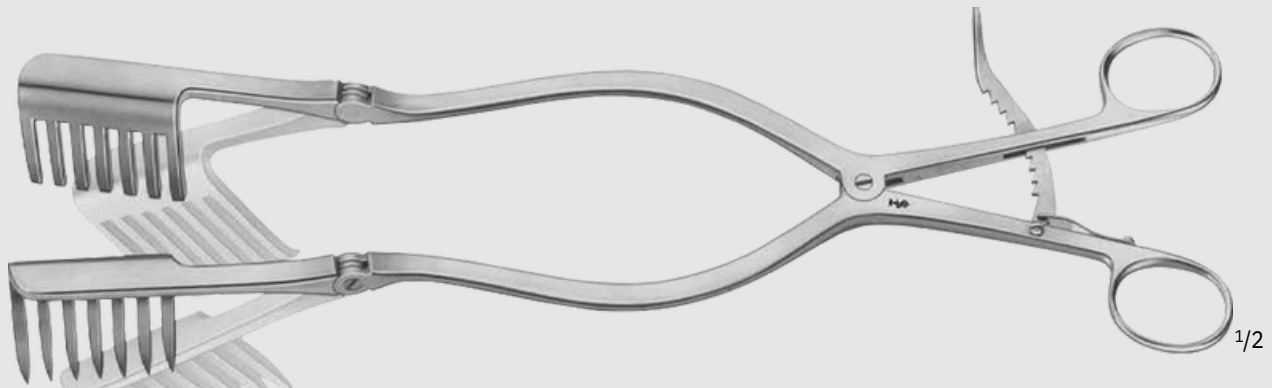

PMSBV276R

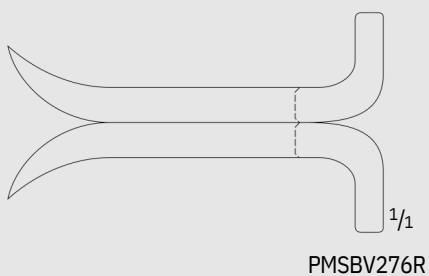

Orthopedics/Spine

Retractors

BECKMANN Retractor, Hinged (continued)

Catalog Number	Tip	Blade End	Length (in.)
PMSMG064R	SHARP	3 x 4 PRONGS	6 1/2
PMSMG371R	BLUNT	3 x 4 PRONGS	6 1/4

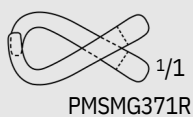
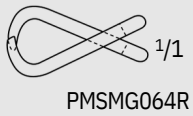
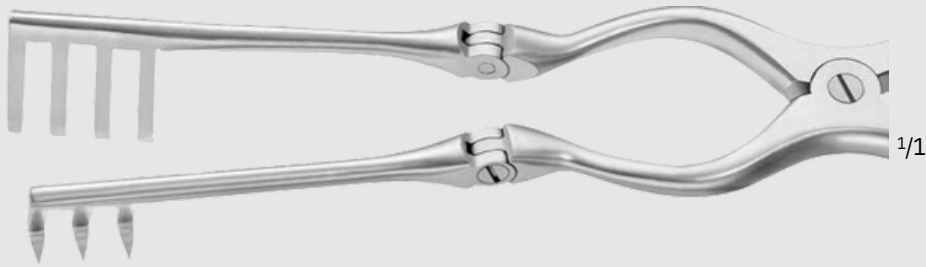
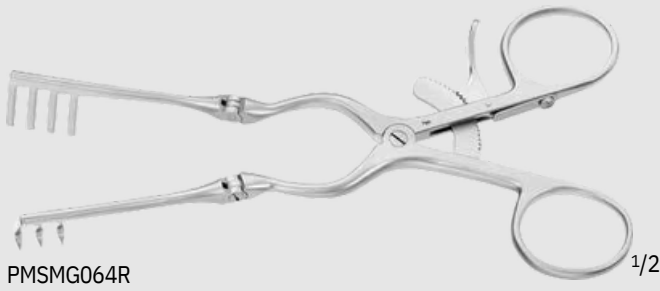

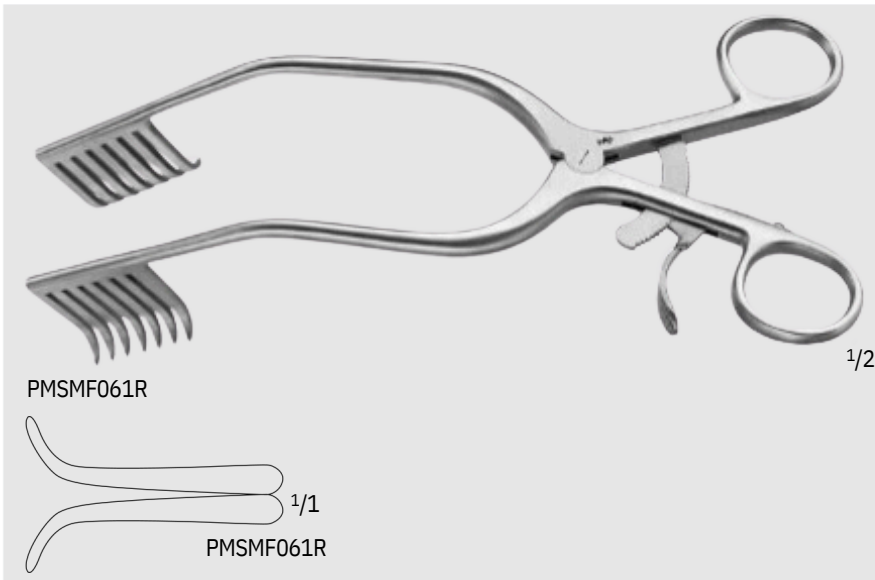

MISKIMON Cerebellum Retractor

Catalog Number	Tip	Blade End	Length (in.)
PMSMF061R	SEMI-S	7 x 7 PRONGS	7 1/2

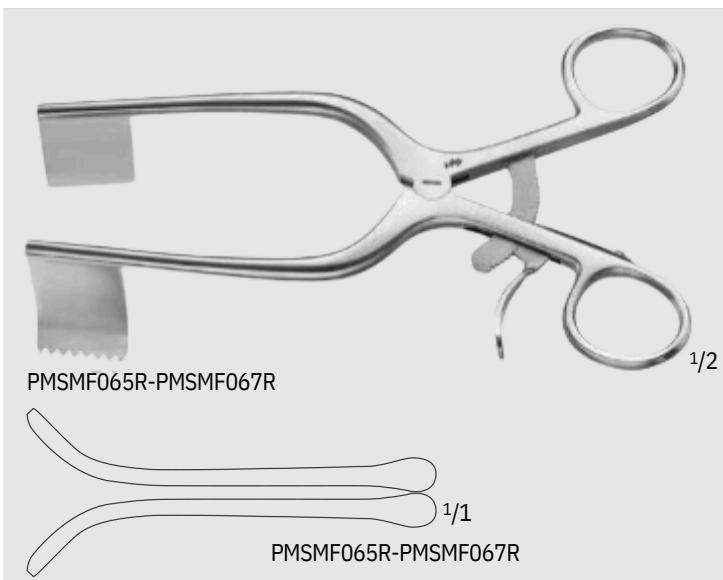

MEYERDING Retractor

Catalog Number	Blade Size (mm)	Length (in.)
PMSMF065R	25 x 57	6 1/2
PMSMF066R	25 x 51	6 1/2
PMSMF067R	25 x 31	6 1/2

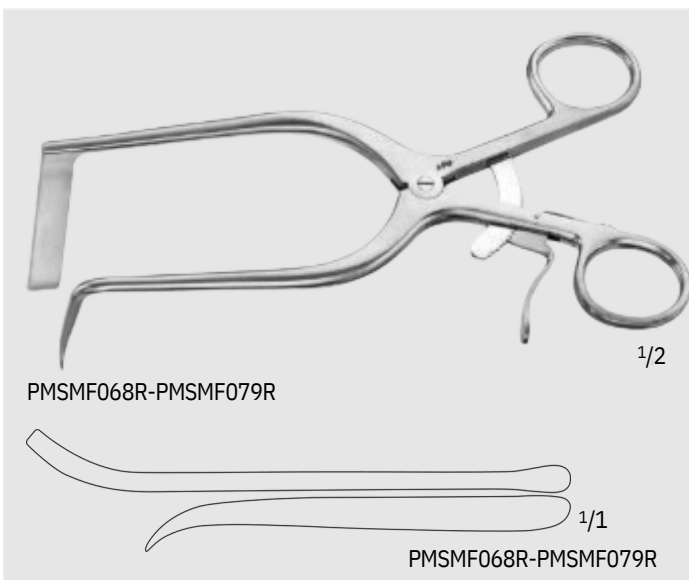

WILLIAMS Retractor

Catalog Number	Tip	Blade Size (mm)	Length (in.)
PMSMF068R	BLADE LEFT	10 x 50	7
PMSMF069R	BLADE RIGHT	10 x 50	7
PMSMF070R	BLADE LEFT	10 x 60	7
PMSMF071R	BLADE RIGHT	10 x 60	7
PMSMF072R	BLADE LEFT	10 x 70	7
PMSMF073R	BLADE RIGHT	10 x 70	7
PMSMF074R	BLADE LEFT	20 x 50	7
PMSMF075R	BLADE RIGHT	20 x 50	7
PMSMF076R	BLADE LEFT	20 x 60	7
PMSMF077R	BLADE RIGHT	20 x 60	7
PMSMF078R	BLADE LEFT	20 x 70	7
PMSMF079R	BLADE RIGHT	20 x 70	7

Orthopedics/Spine

Retractors

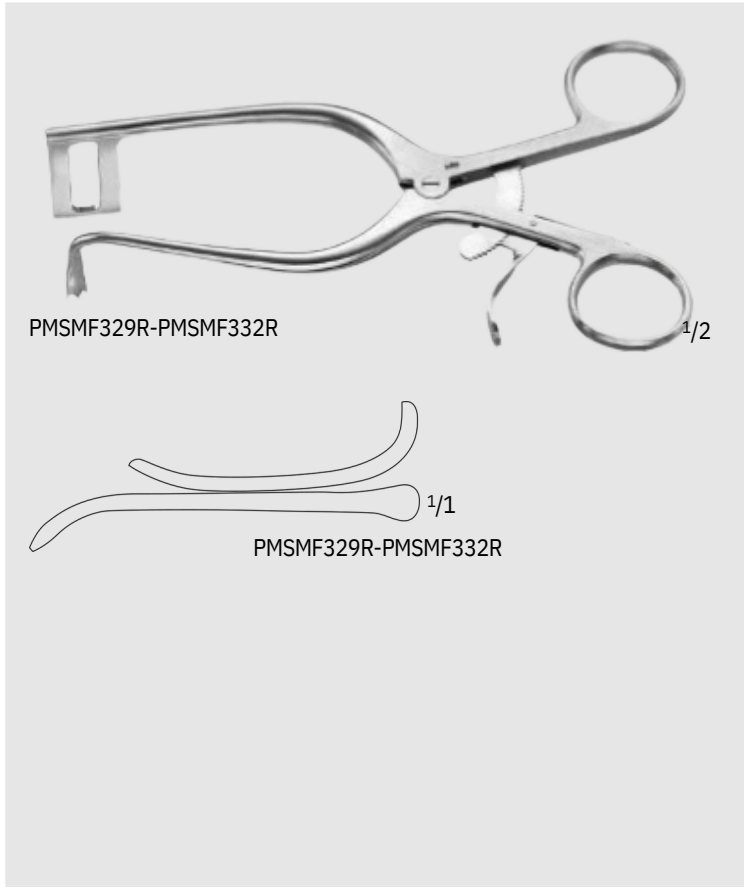

PMSMF329R-PMSMF332R

1/2

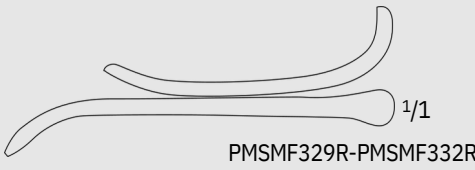

1/1

PMSMF329R-PMSMF332R

DUCKER Retractor

Catalog Number	Tip	Blade Size (mm)	Length (in.)
PMSMF329R	HOOK LEFT	50 x 20	6 3/4
PMSMF330R	HOOK RIGHT	50 x 20	6 3/4
PMSMF331R	HOOK LEFT	70 x 20	6 3/4
PMSMF332R	HOOK RIGHT	70 x 20	6 3/4

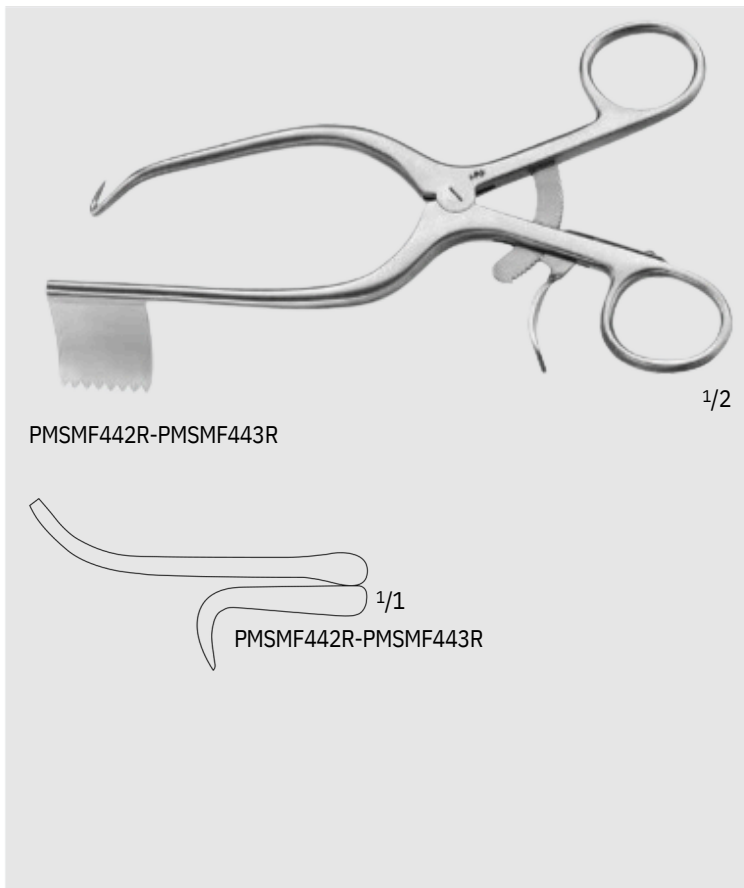

PMSMF442R-PMSMF443R

1/2

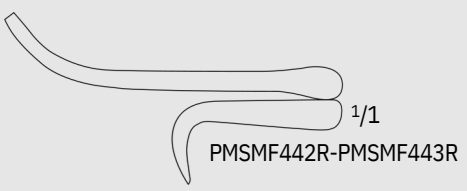

1/1

PMSMF442R-PMSMF443R

MARKHAM-MEYERDING Retractor

Catalog Number	Tip	Blade Size (mm)	Length (in.)
PMSMF442R	BLADE RIGHT	46 x 26	7 1/2
PMSMF443R	BLADE LEFT	46 x 26	7 1/2

Zelpi-Type Retractor, Deep Blade

Catalog Number	Tip	Depth (in.)
PMSMD529R	ANG 45°	3
PMSMD527R	ANG 90°	3
PMSMD528R	ANG 90°	4
PMSMD530R	ANG 90°	5

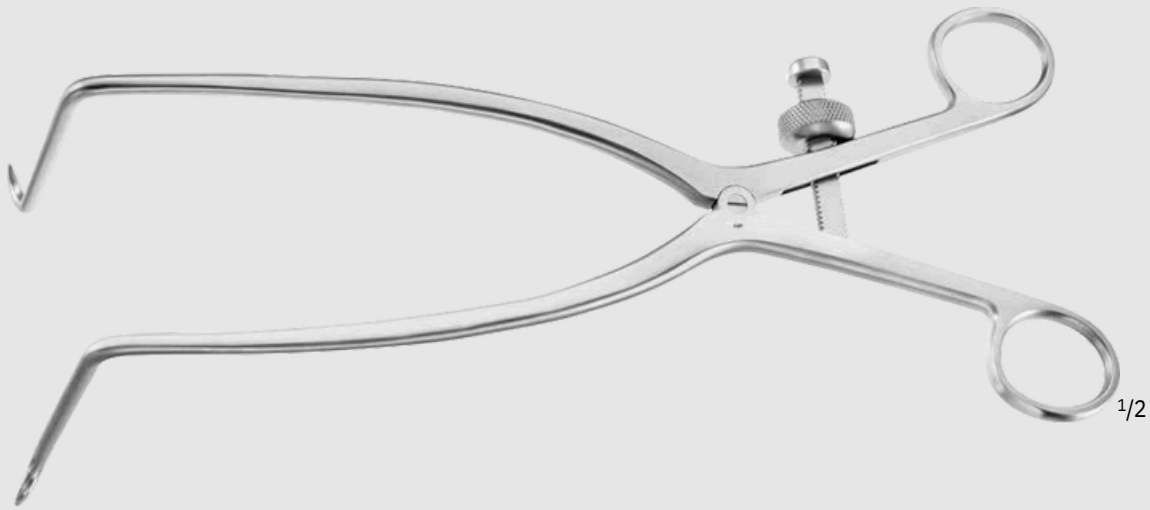

PMSMD529R-PMSMD530R

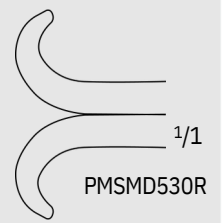
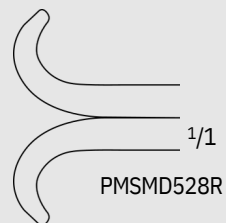
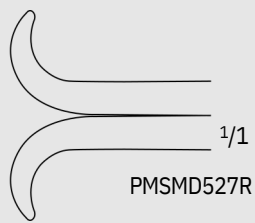
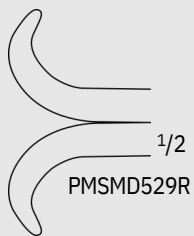

Orthopedics/Spine

Retractors and Spreaders



PMSBV296R

1/2

CLOWARD Lamina Spreader

Catalog Number	Tip	Tip Size (mm)	Length (in.)
PMSBV296R	SERR OUTER	5.0	6 1/8



PMSBV299R

1/2

CLOWARD Lamina Spreader

Catalog Number	Tip	Tip Size (mm)	Length (in.)
PMSBV299R	SERR	4.5	5 1/4

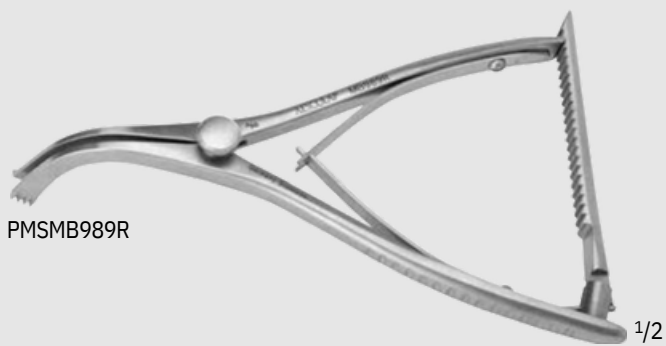

PMSMB989R

1/2

INGE Lamina Spreader

Catalog Number	Tip	Length (in.)
PMSMB989R	TOOTHED	6 1/2



ORTHO
SPINE

INGE Lamina Spreader

Catalog Number	Tip	Tip Size (mm)	Length (in.)
PMSBV297R	SERR	6.0	6 3/4



PMSBV297R

1/2

INGE Lamina Spreader

Catalog Number	Tip	Tip Size (mm)	Length (in.)
PMSBV298R	TOOTHED	12.0	10 3/4

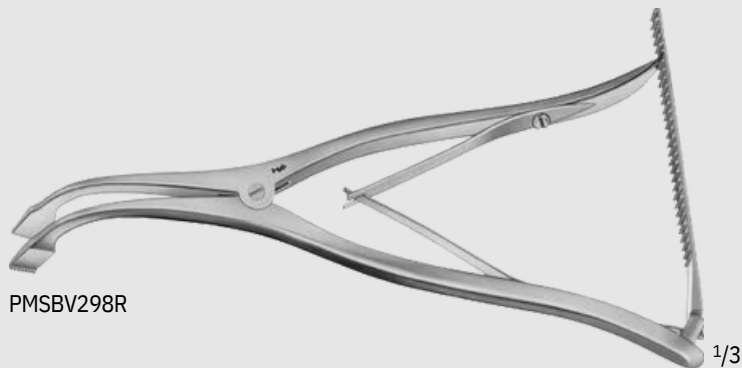

PMSBV298R

1/3



Orthopedics/Spine

Retractors



Aesculap Ball Snap System on Spreader and Blades

Advantages:

- Blades are safely locked without additional fixation, preventing them from detaching when the instrument is passed to the surgeon. In addition, the smooth surface minimizes the risk of catching a suture.
- Blades can be quickly exchanged during the operation.
- Different retractor patterns can be combined and exchanged at random, which allows for optimum selection of the blade size according to surgical needs.



PMSBV510R

SCOVILLE-RICHTER Laminectomy Retractor, Reversible

Catalog Number	Description
PMSBV510R	COMPLETE

PMSBV510R Includes:
 1 Retractor PMSBV509R and
 1 Pair of blades PMSBV516R
 The retractor bar and shanks rotate 180°

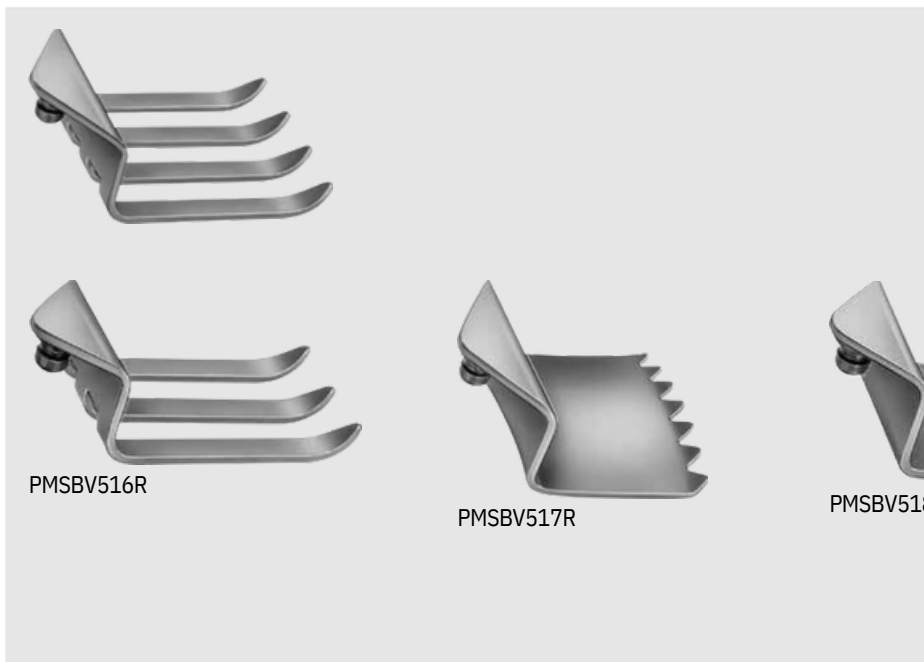

PMSBV516R

PMSBV517R

PMSBV518R

PMSBV519R

SCOVILLE-RICHTER Retractor Blade

Catalog Number	Blade Size (mm)
PMSBV516R	62 x 52 AND 62 x 37, PAIR
PMSBV517R	47 x 51
PMSBV518R	30 x 40
PMSBV519R	37 x 62

■ Complete retraction system consisting of a retractor body, various blade configurations, and storage tray. Designed to enable less invasive spine procedures such as discectomies and decompressions.
 ■ Unique organization system enables easy storage and retrieval of desired blade. ■ Sturdy design provides rigid retraction even at large opening widths. All retractor components are titanium. Blade designs improve visualization and intra-operative imaging. For more information see our brochure number **PMSDOC658**.

- PMSMF393** Includes: 1 Hinged Titanium Retractor Frame PMSMF365T
 2 Wide Blades, 40 mm PMSMF368T
 2 Wide Blades, 50 mm PMSMF369T
 2 Wide Blades, 60 mm PMSMF370T
 2 Wide Blades, 70 mm PMSMF371T
 2 Narrow Blades, 40 mm PMSMF375T
 2 Narrow Blades, 50 mm PMSMF376T
 2 Narrow Blades, 60 mm PMSMF377T
 2 Narrow Blades, 70 mm PMSMF378T
 1 Storage Tray PMSMF392
 1 Hook Blade, 30 mm PMSMF381T
 1 Hook Blade, 40 mm PMSMF382T
 1 Hook Blade, 50 mm PMSMF383T
 1 Hook Blade, 60 mm PMSMF384T
 1 Toothed Blade, 30 mm PMSMF387T
 1 Toothed Blade, 40 mm PMSMF388T
 1 Toothed Blade, 50 mm PMSMF389T
 1 Toothed Blade, 60 mm PMSMF390T

Spine Retractor System

Catalog Number
PMSMF393

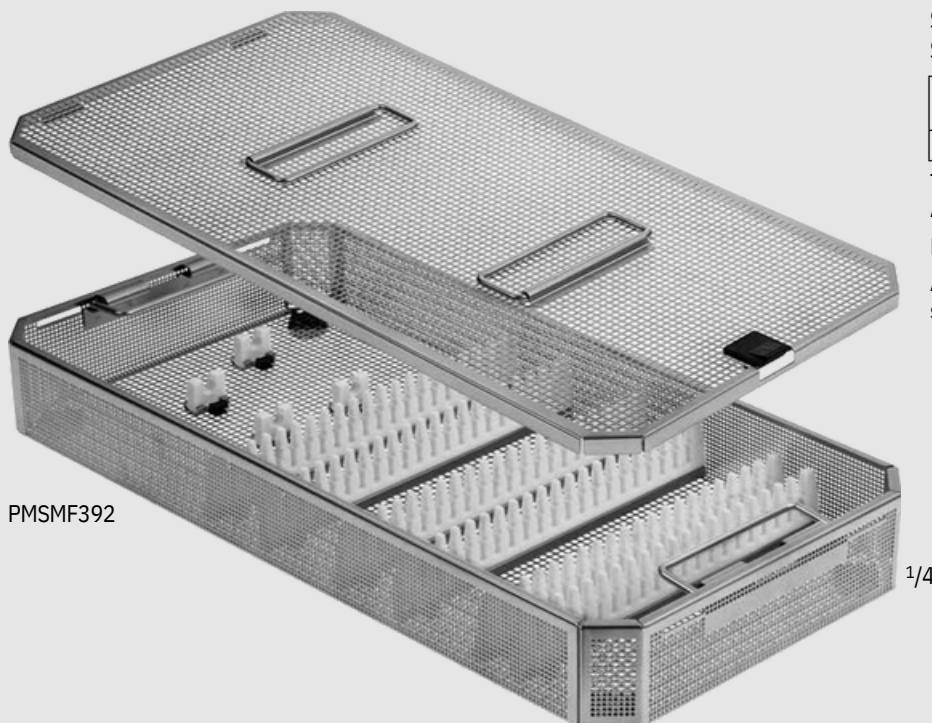

Storage Tray for Spine Retractor System

Catalog Number
PMSMF392

The storage tray will fit into Aesculap's full size container for sterilization.

For more information about Aesculap's SterilContainer System see our brochure number **PMSDOC132**.



Orthopedics/Spine

Retractors



Titanium Retractor Frame, Hinged

Catalog Number
PMSMF365T

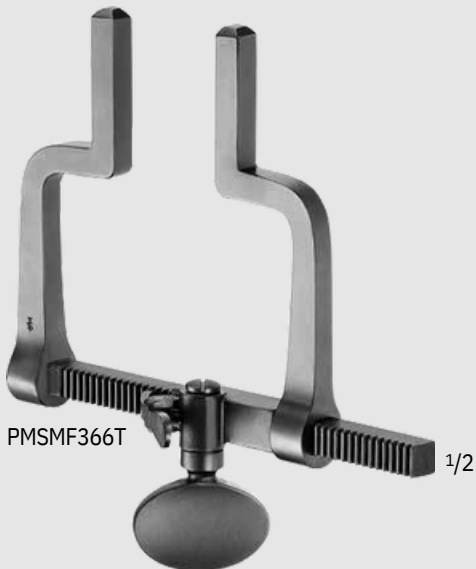

Titanium Retractor Frame, Rigid

Catalog Number
PMSMF366T





PMSMF367T-PMSMF373T

Titanium Retractor Blade, Wide

Catalog Number	Blade Size (mm)
PMSMF367T	27 x 30
PMSMF368T	27 x 40
PMSMF369T	27 x 50
PMSMF370T	27 x 60
PMSMF371T	27 x 70
PMSMF372T	27 x 80
PMSMF373T	27 x 90



PMSMF374T-PMSMF380T

Titanium Retractor Blade, Narrow

Catalog Number	Blade Size (mm)
PMSMF374T	20 x 30
PMSMF375T	20 x 40
PMSMF376T	20 x 50
PMSMF377T	20 x 60
PMSMF378T	20 x 70
PMSMF379T	20 x 80
PMSMF380T	20 x 90



PMSMF381T-PMSMF386T

Titanium Retractor Hook

Catalog Number	Length (mm)
PMSMF381T	30
PMSMF382T	40
PMSMF383T	50
PMSMF384T	60
PMSMF385T	70
PMSMF386T	80



PMSMF387T-PMSMF391T

Titanium Toothed Blades

Catalog Number	Length (mm)
PMSMF387T	30
PMSMF388T	40
PMSMF389T	50
PMSMF390T	60
PMSMF391T	70



Orthopedics/Spine

Retractors

CHARNLEY Initial Incision Retractor

Catalog Number	Description	Blade	Size	Blade Size (mm)
PMSMB191R	SET COMPLETE	-	-	-
PMSMB156R	INDIVIDUAL BLADE	SMALL	STANDARD DEPTH	25 x 38
PMSMB177R	INDIVIDUAL BLADE	SMALL	MEDIUM DEPTH	25 x 75
PMSMB192R	INDIVIDUAL BLADE	SMALL	LONG DEPTH	25 x 127
PMSMB157R	INDIVIDUAL BLADE	LARGE	STANDARD DEPTH	25 x 44
PMSMB178R	INDIVIDUAL BLADE	LARGE	MEDIUM DEPTH	25 x 75
PMSMB193R	INDIVIDUAL BLADE	LARGE	LONG DEPTH	25 x 127
PMSMG081R	WEIGHT AND CHAIN REPLACEMENT FOR MB191R	-	-	-

PMSMB191R includes:

- 1 frame
- 1 small retractor blade (PMSMB156R)
- 1 large retractor blade (PMSMB157R)
- 1 weight w/ chain (3 lbs.)

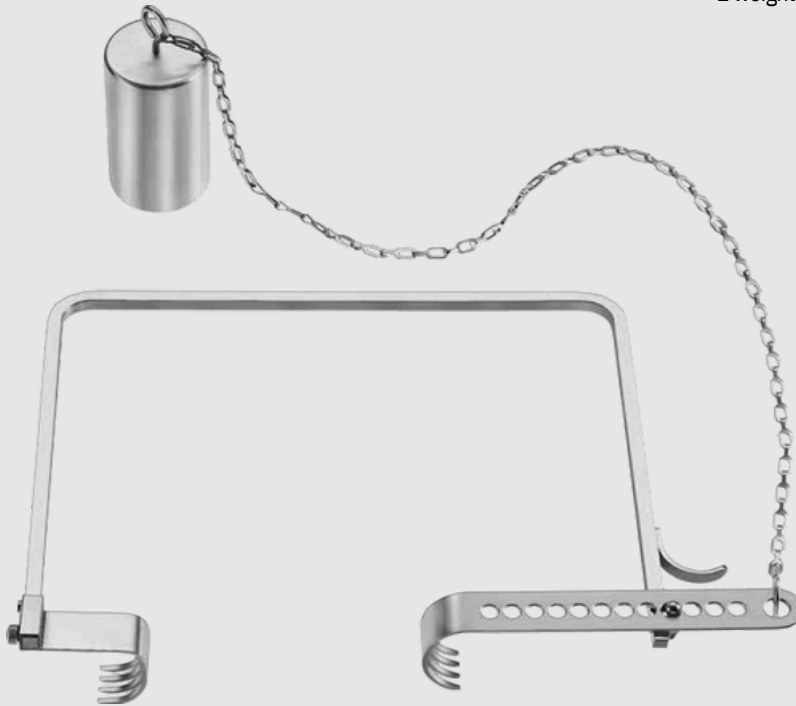

PMSMB191R-PMSMG081R



PMSFK507R

Bone File/Rasp

Catalog Number	Tip Size (mm)	Length (in.)
PMSFK507R	20	8 3/4

One Side File Cut
One Side Rasp Cut



PMSFK507R

Bone File

Catalog Number	Tip Size (mm)	Length (in.)
PMSFK511R	13	9 1/2
PMSFK510R	20	11 5/8



PMSFK511R

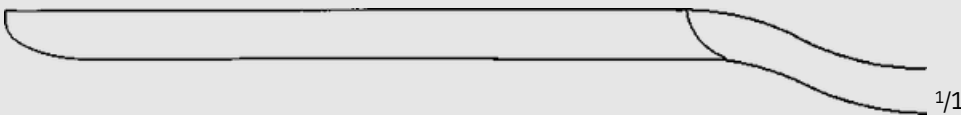

PMSFK511R



PMSFK510R

Orthopedics/Spine

Rasps

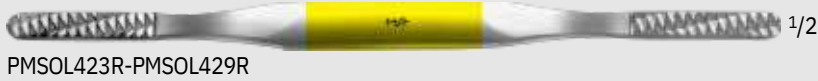

DUROGRIP™ TC FOMON Rasp, Double Ended

Catalog Number	Size	Teeth	Length (in.)
PMSOL423R	3 + 4	16/20	8 1/4
PMSOL425R	5 + 6	24/30	8 1/4
PMSOL427R	7 + 8	36/44	8 1/4
PMSOL429R	9 + 10	52/44	8 1/4

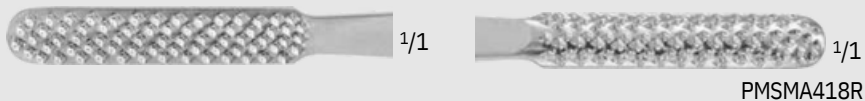
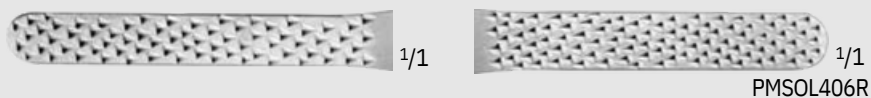
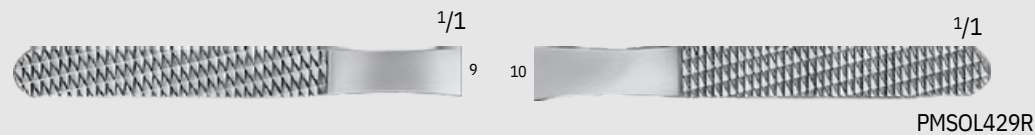
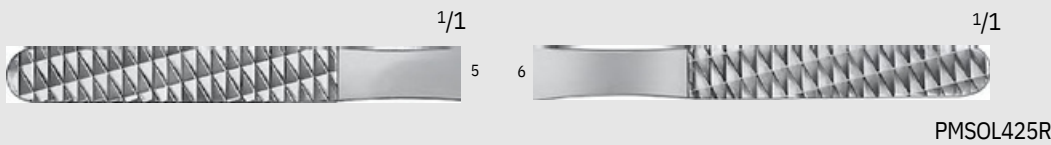

FOMON Bone Rasp, Double Ended

Catalog Number	Tip Size (mm)	Tip	Length (in.)
PMSOL405R	6.5 / 7.5	X-SERR Fine/Coarse	8 1/2
PMSOL406R	6.5 / 7.5	Fine/Coarse	8 1/2
PMSMG584R	8/8	FLAT, CONVEX FINE, COARSE	8 1/2
PMSMA418R	7.5 / 7.5	Coarse/ Xtra-Coarse	8 3/8





MALTZ Bone Rasp

Catalog Number	Tip Size (mm)	Tip	Length (in.)
PMSOL407R	9	DOWN-STROKE	6 1/2
PMSMA419R	33	DOWN-STROKE	6 1/2
PMSMA420R	33	UP STROKE	6 1/2

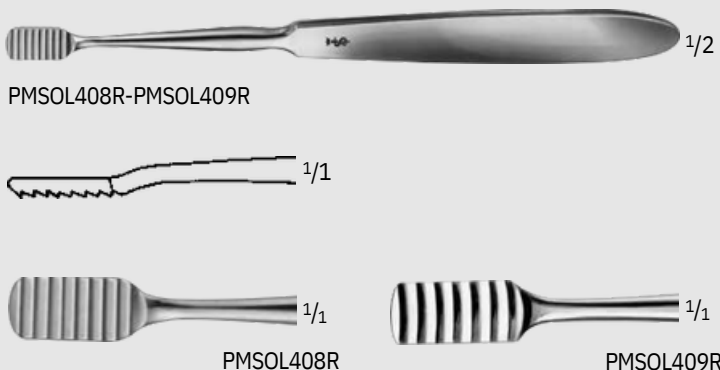

LEWIS Bone Rasp

Catalog Number	Tip	Tip Size (mm)	Length (in.)
PMSOL408R	FINE-SERR DOWN-STROKE	8	6 7/8
PMSOL409R	COARSE-SERR DOWN-STROKE	8	6 7/8

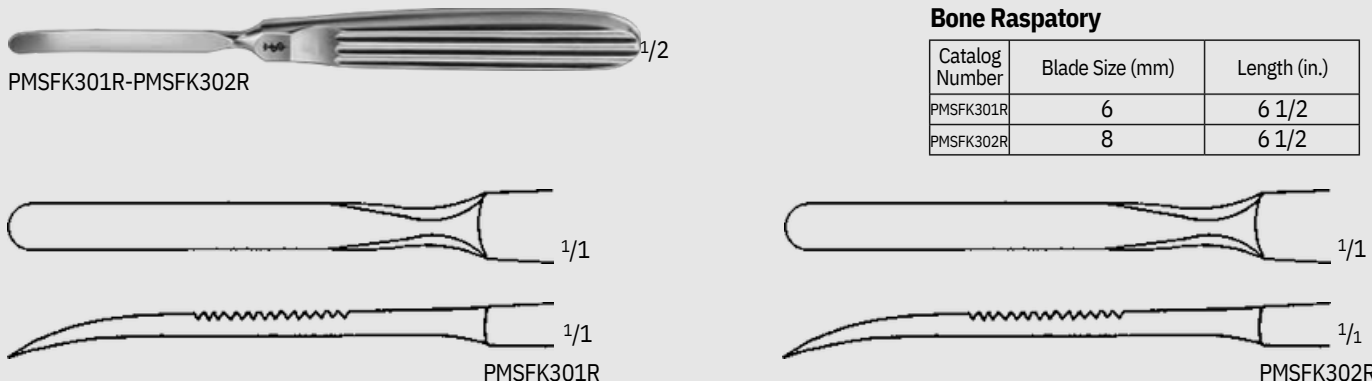

Bone Raspatory

Catalog Number	Blade Size (mm)	Length (in.)
PMSFK301R	6	6 1/2
PMSFK302R	8	6 1/2

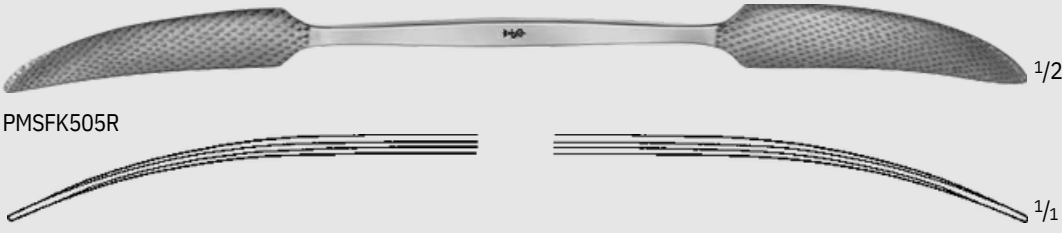

PUTTI Bone File, Double Ended

Catalog Number	Tip Size (mm)	Length (in.)
PMSFK505R	18/20	10 5/8



Orthopedics/Spine

Elevators and Bone Levers



PMSMB816R-PMSMB817R

SAYRE Periosteal Elevator

Catalog Number	Tip	Length (in.)
PMSMB816R	SHARP	6 3/4
PMSMB817R	BLUNT	6 3/4

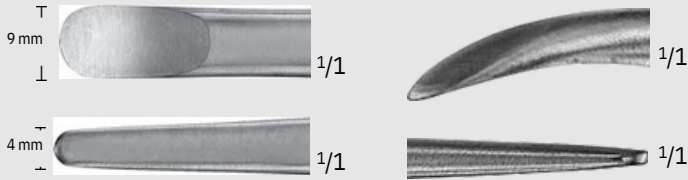

PMSMB816R-PMSMB817R



PMSFK300R

WILLIGER Bone Elevator

Catalog Number	Blade Size (mm)	Length (in.)
PMSFK300R	6	6 1/4

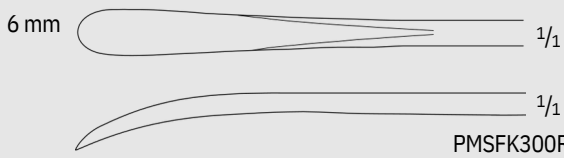

PMSFK300R



PMSFK306R-PMSFK309R

ADSON Elevator

Catalog Number	Tip	Blade Size (mm)	Blade	Length (in.)
PMSFK306R	SHARP	8	STR	6 3/4
FKPMS308R	SEMI-S	7	STR	6 3/4
PMSFK307R	BLUNT	7	CVD	6 3/4
PMSFK309R	SHAR	7	CVD	6 3/4

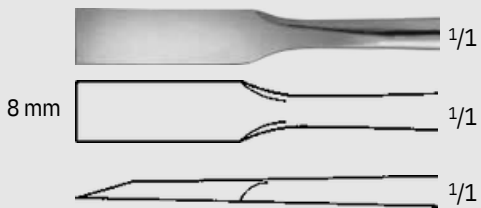

PMSFK306R



PMSFK307R

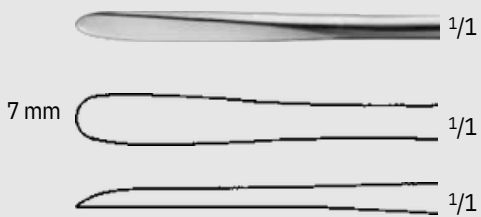

PMSFK308R



PMSFK309R

MCGLAMRY Metatarsal Elevators

Catalog Number	Blade Size (mm)	Length (in.)
PMSMB978R	11	6 1/2
PMSMB979R	13	6 1/2
PMSMB980R	15	6 1/2
PMSMB981R	17	6 1/2

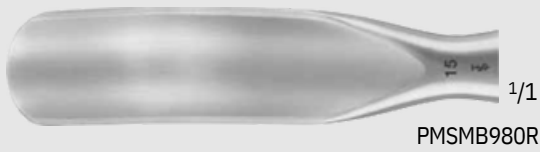

Orthopedics/Spine

Elevators and Bone Levers



PMSFK323R



13 mm

1/1

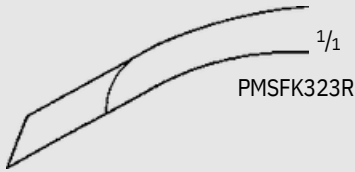

1/1

PMSFK323R

Elevator W/ PEEK Handle

Catalog Number	Tip	Blade Size (mm)	Blade	Length (in.)
PMSFK323R	SHARP	13	CVD	6 7/8



PMSFK324R



14 mm

1/1

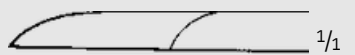

1/1

PMSFK324R

Elevator W/ PEEK Handle

Catalog Number	Tip	Blade Size (mm)	Blade	Length (in.)
PMSFK324R	SHARP	14	STR	7 1/2



PMSFK325R



14 mm

1/1

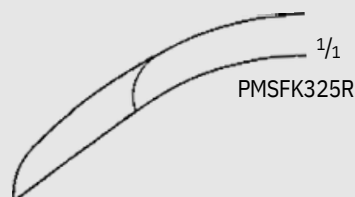

1/1

PMSFK325R

Elevator W/ PEEK Handle

Catalog Number	Tip	Blade Size (mm)	Blade	Length (in.)
PMSFK325R	SHARP	14	CVD	7

ORTHO SPINE

MILLIMETERS



PMSFK360R

16 mm

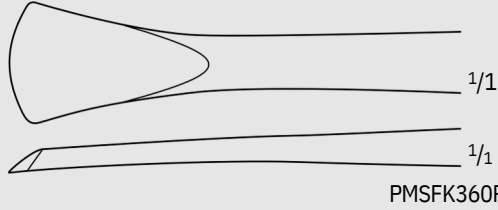

PMSFK360R



PMSMB279R

17 mm

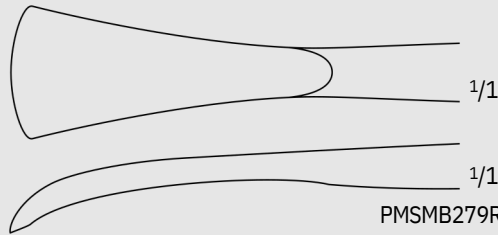

PMSMB279R

LANGENBECK Periosteal Elevator

Catalog Number	Blade Size (mm)	Blade	Length (in.)
PMSFK360R	16	STR	7 1/2
PMSMB279R	17	STR	7 3/4



PMSFK350R

18 mm

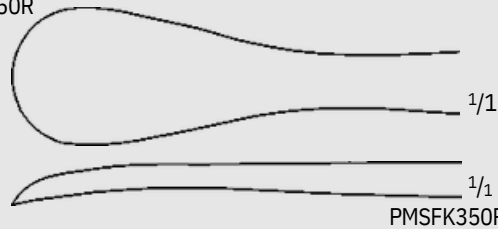

PMSFK350R



PMSFK351R

15 mm

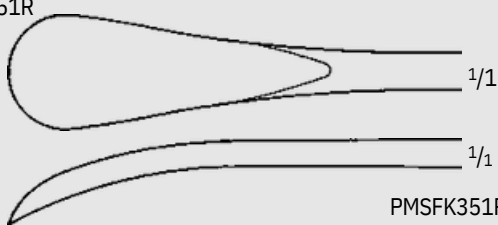

PMSFK351R

SEDILLOT Elevator

Catalog Number	Blade Size (mm)	Blade	Length (in.)
PMSFK350R	18	STR	7 1/4
PMSFK351R	15	CVD	8 1/2



PMSMB536R



PMSMB536R

KEY Periosteal Elevator

Catalog Number	Blade Size (mm)	Length (in.)
PMSMB536R	3.1	6 3/4

Orthopedics/Spine

Elevators and Bone Levers



PMSFK410R-PMSFK414R

KEY Elevator

Catalog Number	Blade Size (mm)	Blade	Length (in.)
PMSFK410R	6.4	STR	7
PMSFK411R	9.5	STR	7 1/2
PMSFK412R	12.7	STR	7 1/2
PMSFK413R	19	STR	7 7/8
PMS FK414R	25.4	STR	8 1/4



PMSMG024R

COBB Elevator, Round

Catalog Number	Blade Size (mm)	Blade	Length (in.)
PMSMG024R	19	CVD	9 1/2

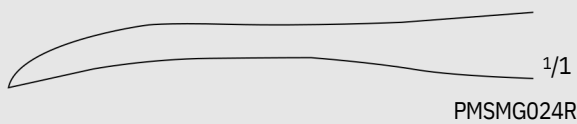
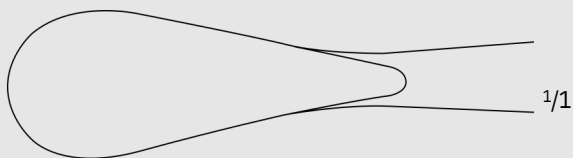

PMSMG024R

COBB Elevator, Sharp

Catalog Number	Blade Size (mm)	Blade	Length (in.)
PMSFK146R	10	CVD	11
PMSFK147R	13	CVD	11
PMSFK148R	19	CVD	11



COBB Periosteal Elevator, Round

Catalog Number	Blade Size (mm)	Blade	Length (in.)
PMSMB518R	7	CVD	12

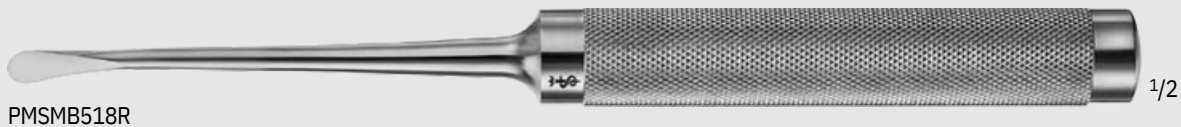

Orthopedics/Spine

Elevators and Bone Levers

COBB Elevator

Catalog Number	Blade Size (mm)	Blade	Length (in.)
PMSMD645	10	ROUND	11
PMSMD646	13	ROUND	11
PMSMD647	19	ROUND	11
PMSMD648	26	ROUND	11
PMSMD649	32	ROUND	11



PMSMD645-PMSMD649

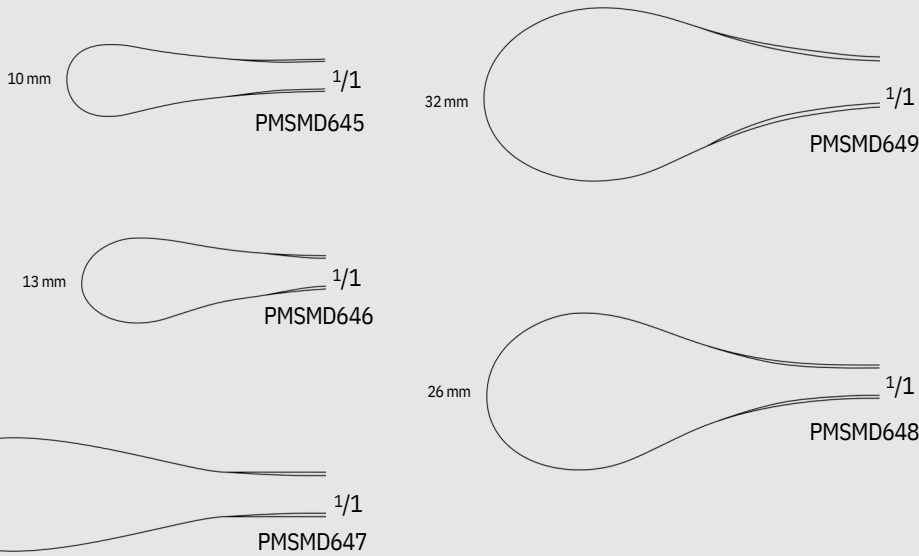

Elevator W/ PEEK Handle

Catalog Number	Blade Size (mm)	Blade	Length (in.)
PMSFK348R	20	CVD	11 1/2



PMSFK348R



WAGNER Elevator W/ PEEK Handle

Catalog Number	Blade Size (mm)	Blade	Length (in.)
PMSFK352R	8	CVD	13
PMSFK353R	17	CVD	13

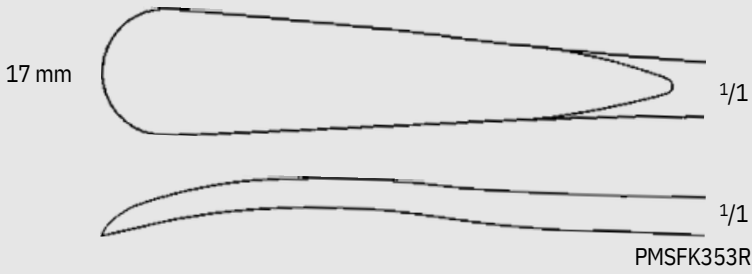
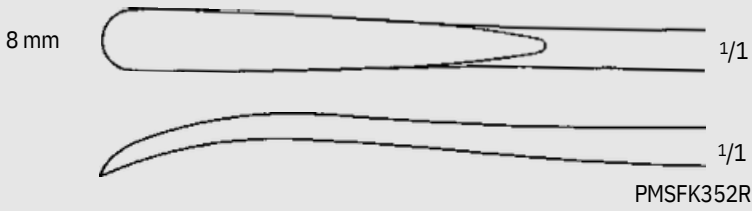

Orthopedics/Spine

Elevators and Bone Levers



PMSMN001R-PMSMN006R

1/3

Black Handled Elevator

Catalog Number	Tip Size (mm)	Handle	Length (in.)
PMSMN001R	10	8 1/2	13 1/4
PMSMN002R	15	8 1/2	13 1/4
PMSMN003R	20	8 1/2	13 1/4
PMSMN004R	25	8 1/2	13 1/4
PMSMN005R	30	8 1/2	13 1/4
PMSMN006R	35	8 1/2	13 1/4
PMSMN007R	9	9	15
PMSMN008R	13	9	15
PMSMN009R	19	9	15
PMSMN010R	25	9	15
PMSMN011R	32	9	15

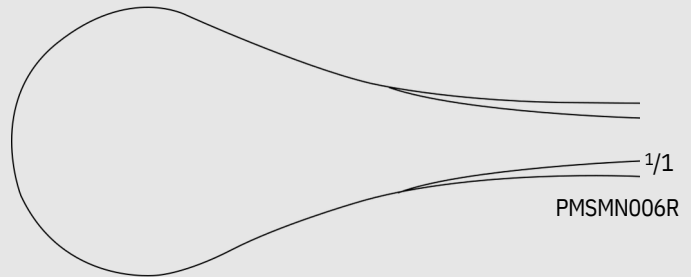
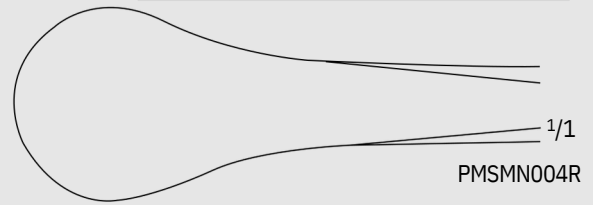
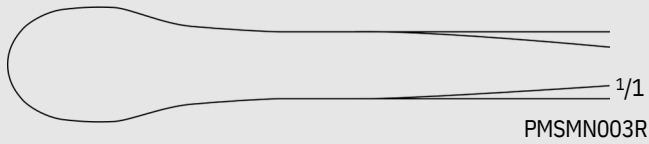
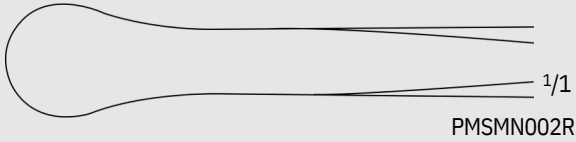
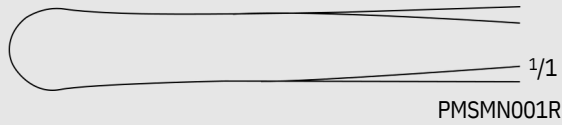

PMSMN007R-
PMSMN011R

1/3

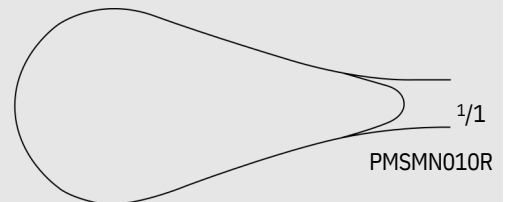
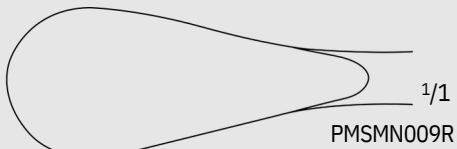
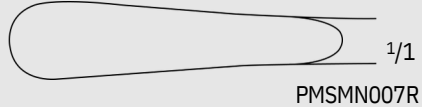



PMSFK120R

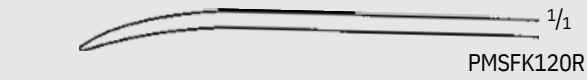

PMSFK120R



PMSFK121R



PMSFK121R

WILLIGER Elevator

Catalog Number	Blade Size (mm)	Blade	Length (in.)
PMSFK120R	5	CVD	6 1/2
PMSFK121R	5.5	CVD	6 3/4



PMSFK124R

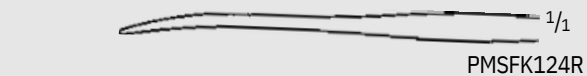
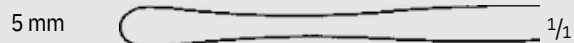

PMSFK124R

SEBILEAU Elevator

Catalog Number	Blade Size (mm)	Blade	Length (in.)
PMSFK124R	5	CVD	6 7/8

Orthopedics/Spine

Elevators and Bone Levers



LANGENBECK Elevator

Catalog Number	Blade Size (mm)	Blade	Length (in.)
PMSFK130R	8	CVD	7 3/4
PMSFK131R	10	CVD	7 3/4
PMSFK139R	11	CVD	9

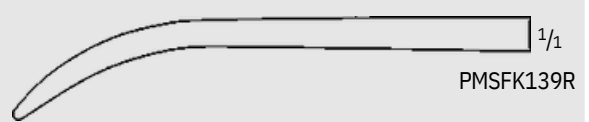
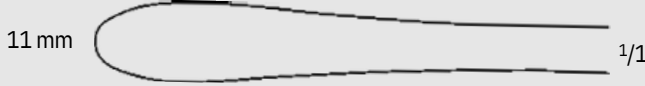
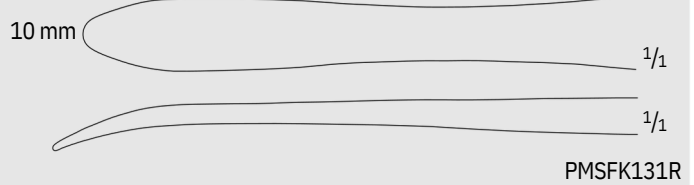

QUERVAIN Elevator, Joker

Catalog Number	Blade Size (mm)	Blade	Length (in.)
PMSFK133R	6	CVD	7 3/4



LANE TRETHOWAN Bone Lever

Catalog Number	Blade	Length (in.)
PMSFK135R	CVD	8 1/2

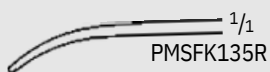

LANE Bone Lever

Catalog Number	Blade	Length (in.)
PMSFK136R	CVD	10

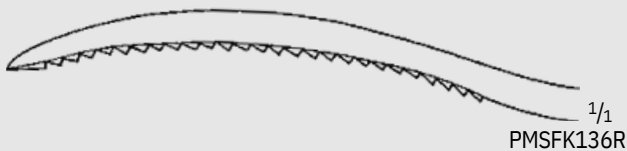



CREGO Elevator

Catalog Number	Tip	Blade Size (mm)	Blade	Length (in.)
PMSMB818R	BLUNT	6.5	CVD	8
PMSMB819R	BLUNT	7.1	CVD	8
PMSMB820R	BLUNT	14.6	CVD	8

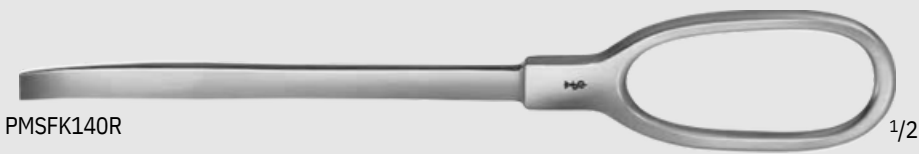

BRISTOW Bone Lever

Catalog Number	Length (in.)
PMSFK140R	5 3/4

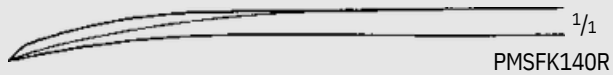

Orthopedics/Spine

Elevators and Bone Levers



PMSFK158R

TAEGER Bone Lever F/ Angle Joint Operations

Catalog Number	Blade Size (mm)	Blade	Length (in.)
PMSFK158R	12	CVD	6 7/8

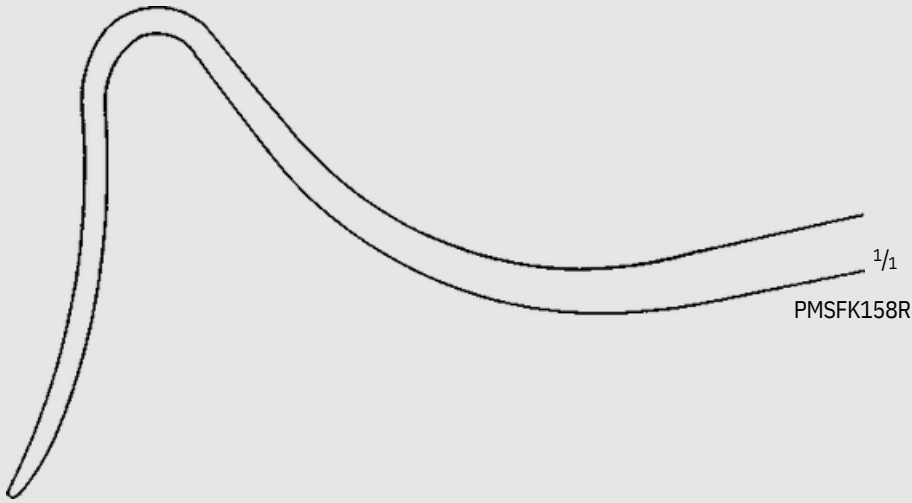

PMSFK158R



CHANDLER Bone Elevator

Catalog Number	Blade Size (mm)	Blade	Length (in.)
PMSMB275R	14	SMALL	7 1/4
PMSMB276R	19	MEDIUM	8
PMSMB277R	25	LARGE	9 1/4
PMSMB278R	30	EXTRA LARGE	10



PMSMB275R-PMSMB278R

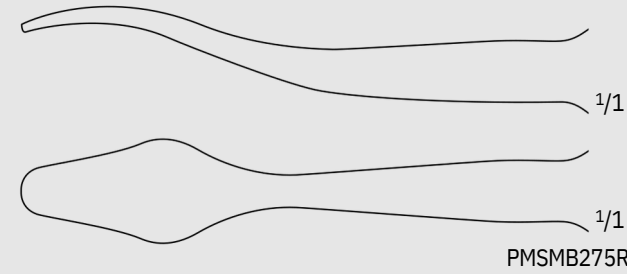

PMSMB275R

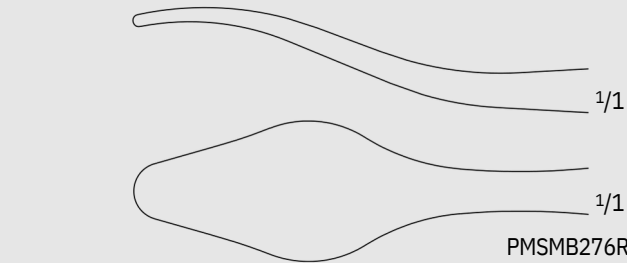

PMSMB276R

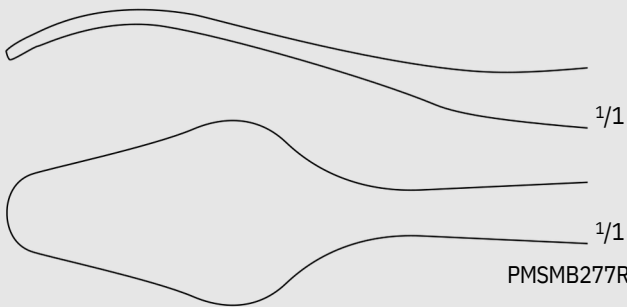

PMSMB277R

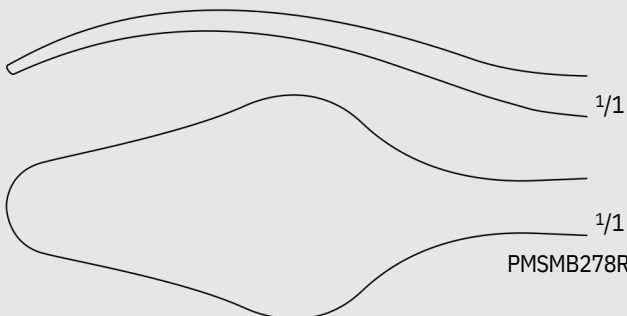

PMSMB278R



Orthopedics/Spine

Chisels, Gouges and Osteotomes



PMSMB850R-PMSMB855R, PMSMB991R

1/2



PMSMB856R-PMSMB859R, PMSMB992R-PMSMB996R

1/2

HIBBS Chisel

Catalog Number	Tip Size (mm)	Blade	Length (in.)
PMSMB850R	7	STR	9 1/2
PMSMB991R	10	STR	9 1/2
PMSMB851R	15	STR	9 1/2
PMSMB852R	19	STR	9 1/2
PMSMB853R	22	STR	9 1/2
PMSMB854R	25	STR	9 1/2
PMSMB855R	38	STR	9 1/2
PMSMB856R	7	CVD	9 1/2
PMSMB857R	9	CVD	9 1/2
PMSMB992R	13	CVD	9 1/2
PMSMB858R	15	CVD	9 1/2
PMSMB859R	19	CVD	9 1/2
PMSMB993R	22	CVD	9 1/2
PMSMB994R	25	CVD	9 1/2
PMSMB995R	32	CVD	9 1/2
PMSMB996R	38	CVD	9 1/2



PMSFL503R-PMSFL507R

1/2

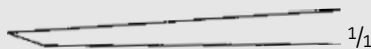

PMSFL503R-PMSFL507R

1/1

STILLE Chisel

Catalog Number	Tip Size (mm)	Length (in.)
PMSFL503R	10	8
PMSFL504R	12	8
PMSFL505R	15	8
PMSFL506R	20	8
PMSFL507R	25	8

Chisel Handle F/ Interchangeable Blades

Catalog Number	Item
PMSFL665R	HANDLE W/KEY
PMSGB020R	REPLACEMENT KEY



PMSFL665R

1/2

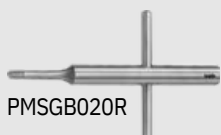

PMSGB020R



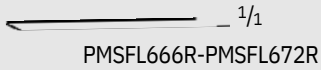

Chisel Blade, F/FL665R

Catalog Number	Tip Size (mm)	Tip Size (in.)	Working Length (mm)
PMSFL666R	5	3/16	45
PMSFL668R	10	3/8	45
PMSFL670R	16	5/8	45
PMSFL672R	25	1	45

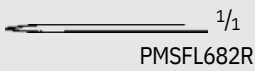

Osteotome Blade, F/FL665R

Catalog Number	Tip Size (mm)	Tip Size (in.)	Working Length (mm)
PMSFL682R	25	1	78

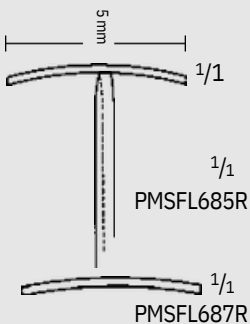

Concave Chisel Blade, F/FL665R

Catalog Number	Radius (mm)	Tip Size (mm)	Tip Size (in.)
PMSFL685R	50	25	1
PMSFL687R	70	25	1

Orthopedics/Spine

Chisels, Gouges and Osteotomes

Lamina Gouge W/ HARTPRESS Handle

Catalog Number	Tip Size (mm)	Tip Size (in.)	Length (in.)
PMSFL437R	6	1/4	9 1/4
PMSFL438R	8	5/16	9 1/4
PMSFL439R	11	7/16	9 1/4
PMSFL440R	16	5/8	9 1/4

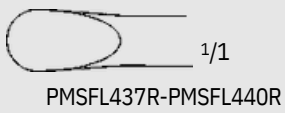

Chisel W/ PEEK Handle

Catalog Number	Tip Size (mm)	Tip Size (in.)	Length (in.)
PMSFL430R	20	3/4	9 5/8

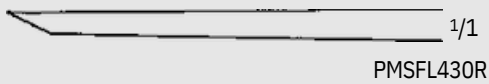

LEXER-MINI Gouge W/ PEEK Handle

Catalog Number	Tip Size (mm)	Tip Size (in.)	Length (in.)
PMSFL390R	4	5/32	7
PMSFL391R	6	1/4	7
PMSFL392R	8	5/16	7
PMSFL393R	10	3/8	7
PMSFL394R	12	1/2	7

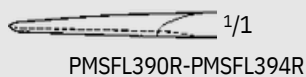



PMSFL411R-PMSFL418R

1/2

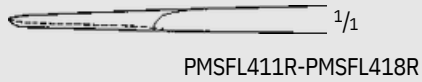

PMSFL411R-PMSFL418R

1/1

LEXER Gouge W/ PEEK Handle

Catalog Number	Tip Size (mm)	Tip Size (in.)	Length (in.)
PMSFL411R	5	3/16	8 7/8
PMSFL412R	7	9/32	8 7/8
PMSFL413R	10	3/8	8 7/8
PMSFL415R	15	5/8	8 7/8
PMSFL416R	20	3/4	8 7/8
PMSFL417R	25	1	8 7/8
PMSFL418R	30	1 3/16	8 7/8



PMSFL420R

1/2

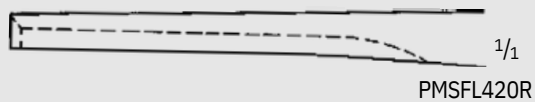

PMSFL420R

1/1

Gouge, F/ Removing Broken Screws, W/ PEEK Handle

Catalog Number	Tip Size (mm)	Tip Size (in.)	Length (in.)
PMSFL420R	9	3/8	8 7/8



PMSFL423R

1/2

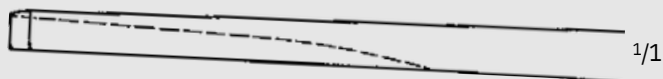

1/1



1/1



1/1

PMSFL423R

LEXER Spongiosa Gouge W/ PEEK Handle

Catalog Number	Tip Size (mm)	Tip Size (in.)	Length (in.)
PMSFL423R	10	3/8	11

Orthopedics/Spine

Chisels, Gouges and Osteotomes



ZIELKE Gouge W/ PEEK Handle

Catalog Number	Tip Size (mm)	Tip Size (in.)	Length (in.)
PMSFL701R	5.5	7/32	9
PMSFL702R	9	3/8	9



Spongiosa Gouge W/ PEEK Handle

Catalog Number	Tip Size (mm)	Tip Size (in.)	Blade	Length (in.)
PMSFL441R	5	3/16	CVD	9 3/4
PMSFL443R	10	3/8	CVD	9 3/4
PMSFL445R	15	5/8	CVD	9 3/4

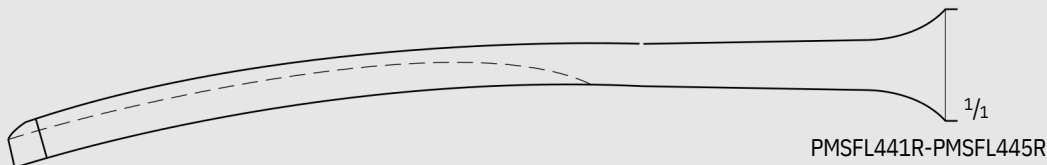

STILLE Gouge

Catalog Number	Tip Size (mm)	Tip Size (in.)	Length (in.)
PMSFL573R	10	3/8	8
PMSFL574R	12	1/2	8
PMSFL575R	15	5/8	8
PMSFL576R	20	3/4	8
PMSFL577R	25	1	8

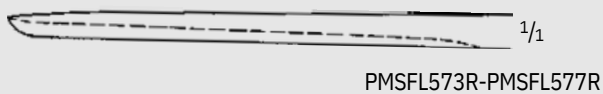

WAGNER Gouge W/ PEEK Handle

Catalog Number	Tip Size (mm)	Tip Size (in.)	Blade Shape	Length (in.)
PMSND120R	9 9	3/8	ANG FWD	13 3/8
PMSND121R	15	3/8	ANG BACK	13 3/8
PMSND122R	15 9	5/8	ANG FWD	13 3/8
PMSND123R	15	5/8	ANG BACK	13 3/8
PMSND124R		3/8	STR	13 3/8
PMSND125R		5/8	STR	13 3/8



PMSND120R-PMSND125R

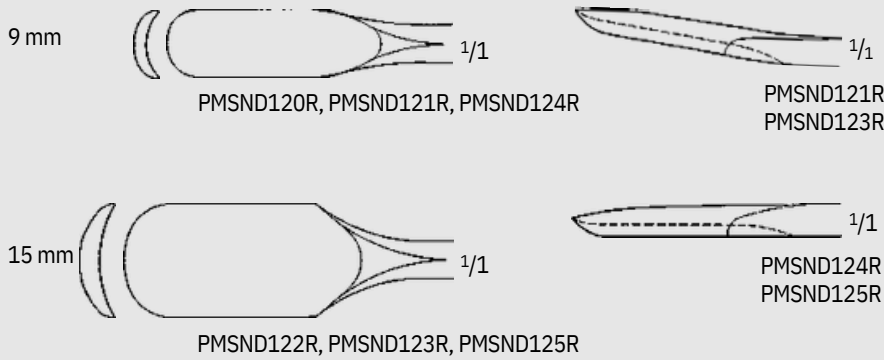

SMITH-PETERSON Gouge

Catalog Number	Tip	Tip Size (mm)	Length (in.)
PMSMF465R	STR	6	8
PMSMF466R	STR	10	8
PMSMF467R	STR	13	8
PMSMF468R	STR	16	8
PMSMF469R	STR	19	8
PMSMF470R	STR	25	8
PMSMF471R	STR	32	8
PMSMF472R	CVD	6	8
PMSMF473R	CVD	10	8
PMSMF474R	CVD	13	8
PMSMF475R	CVD	16	8
PMSMF476R	CVD	19	8
PMSMF477R	CVD	25	8
PMSMF478R	CVD	32	8



PMSMF465R-PMSMF478R

Orthopedics/Spine

Chisels, Gouges and Osteotomes



PMSFL380R-PMSFL384R

1/2



1/1

PMSFL380R-PMSFL384R

LEXER-MINI Osteotome W/ PEEK Handle

Catalog Number	Tip Size (mm)	Tip Size (in.)	Length (in.)
PMSFL380R	4	5/32	7
PMSFL381R	6	1/4	7
PMSFL382R	8	5/16	7
PMSFL383R	10	3/8	7
PMSFL384R	12	1/2	7



PMSFL401R-PMSFL408R

1/2



1/1

PMSFL401R-PMSFL408R

LEXER Osteotome W/ PEEK Handle

Catalog Number	Tip Size (mm)	Tip Size (in.)	Length (in.)
PMSFL401R	5	3/16	8 7/8
PMSFL402R	7	9/32	8 7/8
PMSFL403R	10	3/8	8 7/8
PMSFL405R	15	5/8	8 7/8
PMSFL406R	20	3/4	8 7/8
PMSFL407R	25	1	8 7/8
PMSFL408R	30	1 3/16	8 7/8
PMSND108R	10	3/8	10 3/4
PMSND109R	15	5/8	10 3/4



PMSND108R-PMSND109R

1/2

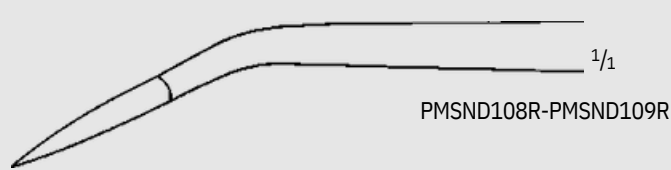

1/1

PMSND108R-PMSND109R

Chisel W/ PEEK Handle

Catalog Number	Tip Size (mm)	Tip Size (in.)	Length (in.)
PMSND105R	16	5/8	10 1/2



PMSND105R

1/2

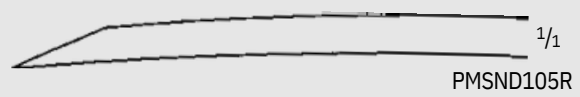

1/1

PMSND105R



COBB Gouge

Catalog Number	Blade	Length (in.)
PMSMB707R	STR	11 1/2



Gouge, Double Curved, W/ HARTPRESS Handle

Catalog Number	Tip Size (mm)	Tip Size (in.)	Length (in.)
PMSND118R	25	1	11 1/4



HIBBS Gouge

Catalog Number	Tip Size (mm)	Tip Size (in.)	Blade	Length (in.)
PMSMB709R	16	5/8	STR	9 1/2
PMSMB710R	19	3/4	STR	9 1/2
PMSMB711R	22	7/8	STR	9 1/2
PMSMB712R	25	1	STR	9 1/2
PMSMB713R	28	1 1/8	STR	9 1/2
PMSMB714R	32	1 1/4	STR	9 1/2
PMSMB715R	38	1 1/2	STR	9 1/2
PMSMB716R	6	1/4	CVD	9 1/2
PMSMB717R	9	3/8	CVD	9 1/2
PMSMB718R	13	1/2	CVD	9 1/2
PMSMB719R	13	5/8	CVD	9 1/2
PMSMB720R	19	3/4	CVD	9 1/2
PMSMB721R	25	1	CVD	9 1/2
PMSMB722R	28	1 1/8	CVD	9 1/2
PMSMB723R	38	1 1/2	CVD	9 1/2

Orthopedics/Spine

Chisels, Gouges and Osteotomes



PMSFL156R-PMSFL170R

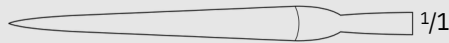

PMSFL156R-PMSFL160R

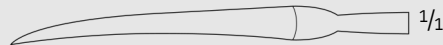

PMSFL166R-PMSFL170R

HOKE Osteotome

Catalog Number	Tip Size (mm)	Tip Size (in.)	Blade	Length (in.)
PMSFL156R	3	1/8	STR	6 1/8
PMSFL157R	6	1/4	STR	6 1/8
PMSFL158R	10	3/8	STR	6 1/8
PMSFL159R	13	1/2	STR	6 1/8
PMSFL160R	16	5/8	STR	6 1/8
PMSFL166R	3	1/8	CVD	6 1/8
PMSFL167R	6	1/4	CVD	6 1/8
PMSFL168R	10	3/8	CVD	6 1/8
PMSFL169R	13	1/2	CVD	6 1/8
PMSFL170R	16	5/8	CVD	6 1/8



PMSFL512R-PMSFL517R



PMSFL512R-PMSFL517R



PMSFL523R-PMSFL527R

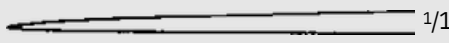

PMSFL523R-PMSFL527R



PMSFL553R-PMSFL557R

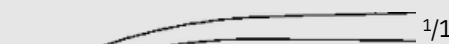

PMSFL553R-PMSFL557R

STILLE Osteotome

Catalog Number	Tip Size (mm)	Tip Size (in.)	Blade	Length (in.)
PMSFL512R	8	5/16	STR, HVY	8
PMSFL513R	10	3/8	STR, HVY	8
PMSFL514R	12	1/2	STR, HVY	8
PMSFL515R	15	5/8	STR, HVY	8
PMSFL516R	20	3/4	STR, HVY	8
PMSFL517R	25	1	STR, HVY	8
PMSFL523R	10	3/8	STR	8
PMSFL524R	12	1/2	STR	8
PMSFL525R	15	5/8	STR	8
PMSFL526R	20	3/4	STR	8
PMSFL527R	25	1	STR	8
PMSFL553R	10	3/8	CVD	8
PMSFL554R	12	1/2	CVD	8
PMSFL555R	15	5/8	CVD	8
PMSFL556R	20	3/4	CVD	8
PMSFL557R	25	1	CVD	8

ORTHO
SPINE

MILLIMETERS

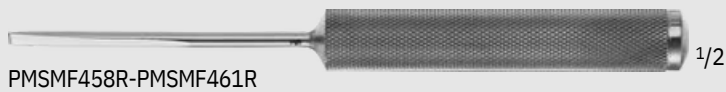

PMSMF458R-PMSMF461R

1/2



1/1

PMSMF458R-PMSMF461R

Gouge

Catalog Number	Tip Size (mm)	Tip	Length (in.)
PMSMF458R	4	CVD	7
PMSMF459R	4	STR	7
PMSMF460R	6	CVD	7 1/2
PMSMF461R	6	STR	7 1/2



PMSMB657R-PMSMB669R

1/2

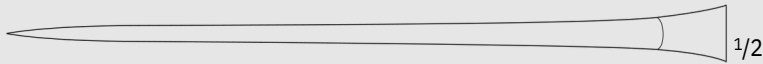

1/2

PMSMB657R-PMSMB662R

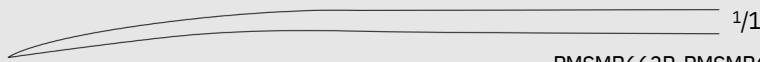

1/1

PMSMB663R-PMSMB669R

SMITH-PETERSON Osteotome

Catalog Number	Tip Size (mm)	Tip Size (in.)	Blade	Length (in.)
PMSMB657R	7	9/32	STR	8
PMSMB658R	11	7/16	STR	8
PMSMB659R	14	9/16	STR	8
PMSMB660R	17	21/32	STR	8
PMSMB661R	19	3/4	STR	8
PMSMB662R	25	1	STR	8
PMSMB663R	6	1/4	CVD	8
PMSMB664R	9.5	3/8	CVD	8
PMSMB665R	13	1/2	CVD	8
PMSMB666R	16	5/8	CVD	8
PMSMB667R	19	3/4	CVD	8
PMSMB668R	25	1	CVD	8
PMSMB669R	32	1 1/4	CVD	8



PMSMB675R-PMSMB684R

1/2

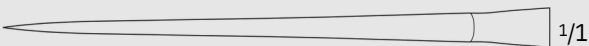

1/1

PMSMB675R-PMSMB684R



PMSMB685R-PMSMB694R

1/2



1/1

PMSMB685R-PMSMB694R

HIBBS Osteotome

Catalog Number	Tip Size (mm)	Tip Size (in.)	Blade	Length (in.)
PMSMB675R	6	1/4	STR	9 5/8
PMSMB676R	10	3/8	STR	9 5/8
PMSMB677R	13	1/2	STR	9 5/8
PMSMB678R	16	5/8	STR	9 5/8
PMSMB679R	19	3/4	STR	9 5/8
PMSMB680R	22	7/8	STR	9 5/8
PMSMB681R	25	1	STR	9 5/8
PMSMB682R	28	1 1/8	STR	9 5/8
PMSMB683R	32	1 1/4	STR	9 5/8
PMSMB684R	38	1 1/2	STR	9 5/8
PMSMB685R	6	1/4	CVD	9 5/8
PMSMB686R	10	3/8	CVD	9 5/8
PMSMB687R	13	1/2	CVD	9 5/8
PMSMB688R	16	5/8	CVD	9 5/8
PMSMB689R	19	3/4	CVD	9 5/8
PMSMB690R	22	7/8	CVD	9 5/8
PMSMB691R	25	1	CVD	9 5/8
PMSMB692R	28	1 1/8	CVD	9 5/8
PMSMB693R	32	1 1/4	CVD	9 5/8
PMSMB694R	38	1 1/2	CVD	9 5/8



Orthopedics/Spine

Chisels, Gouges and Osteotomes

COBB Osteotomes

Catalog Number	Tip Size (mm)	Blade	Length (in.)
PMSMB084R	6	STR	11
PMSMB085R	10	STR	11
PMSMB742R	13	STR	11
PMSMB087R	13	STR	11
PMSMB088R	16	STR	11
PMSMB089R	19	STR	11
PMSMB090R	25	STR	11
PMSMG030R	6	CVD	11
PMSMG031R	10	CVD	11
PMSMG032R	13	CVD	11
PMSMG033R	16	CVD	11
PMSMG036R	19	CVD	11
PMSMG034R	25	CVD	11
PMSMG035R	32	CVD	11

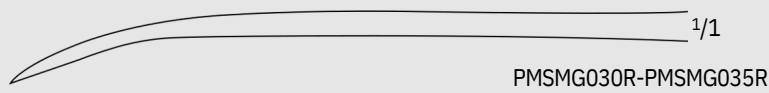
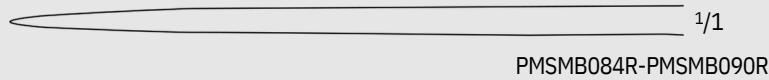
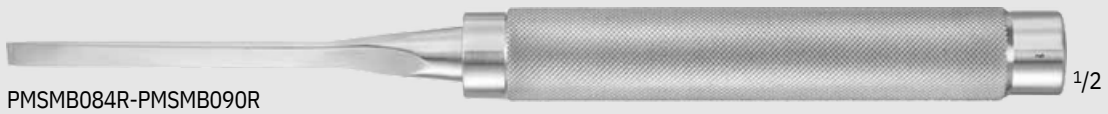

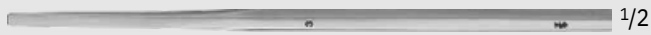

PMSMB404R-PMSMB373R



PMSMB404R-PMSMB373R

Osteotome W/ Hexagonal Handle

Catalog Number	Tip Size (mm)	Length (in.)
PMSMB404R	2	6 1/4
PMSMB405R	3	6 1/4
PMSMB406R	4	6 1/4
PMSMB407R	5	6 1/4
PMSMB408R	6	6 1/4
PMSMB409R	7	6 1/4
PMSMB410R	8	6 1/4
PMSMB411R	9	6 1/4
PMSMB412R	10	6 1/4
PMSMB413R	11	6 1/4
PMSMB373R	12	6 1/4



PMSMB398R-PMSMB403R



PMSMB398R-PMSMB403R

CONVERSE Osteotome

Catalog Number	Tip Size (mm)	Length (in.)
PMSMB398R	2	7
PMSMB399R	4	7
PMSMB400R	6	7
PMSMB401R	8	7
PMSMB402R	10	7
PMSMB403R	12	7



PMSMB388R-PMSMB389R

RUBIN Osteotome, W/ Finger Grip

Catalog Number	Tip Size (mm)	Length (in.)
PMSMB388R	10	6 1/2
PMSMB389R	14	6 1/2



Orthopedics/Spine

Chisels, Gouges and Osteotomes



PMSFL088R-PMSMG049R



PMSFL088R-PMSMG049R



PMSMG037R-PMSMG044R



PMSMG037R-PMSMG044R

LAMBOTTE Osteotome

Catalog Number	Tip Size (mm)	Blade	Length (in.)
PMSMG050R	SET OF 7	STR	-
PMSFL088R	2	STR	5
PMSFL101R	4	STR	5
PMSFL102R	6	STR	5
PMSFL104R	8	STR	5
PMSFL106R	10	STR	5
PMSFL108R	12	STR	5
PMSMG046R	14	STR	5
PMSFL109R	15	STR	5
PMSMG047R	18	STR	5
PMSMG048R	19	STR	5
PMSMG049R	20	STR	5
PMSMG037R	2	CVD	5
PMSMG038R	4	CVD	5
PMSMG039R	6	CVD	5
PMSMG040R	8	CVD	5
PMSMG041R	10	CVD	5
PMSMG042R	12	CVD	5
PMSMG043R	14	CVD	5
PMSMG044R	15	CVD	5

LAMBOTTE MINI OSTEOTOME SET:
CONTAINS SEVEN MG050R STRAIGHT 5"
OSTEOTOMES:
2MM, 4MM, 6MM, 8MM, 10MM, 12MM,
14MM PLUS Mallet (PMSFL036R)

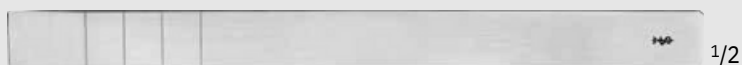

PMSMB621R-PMSMB628R



PMSMB620R-PMSMB628R

LAMBOTTE Osteotome with Calibrations

Catalog Number	Tip Size (mm)	Blade	Length (in.)
PMSMB620R	COMPLETE SET	-	-
PMSMB621R	4	STR	7 1/4
PMSMB622R	6	STR	7 1/4
PMSMB623R	7	STR	7 1/4
PMSMB624R	8	STR	7 1/4
PMSMB625R	10	STR	7 1/4
PMSMB626R	12	STR	7 1/4
PMSMB627R	16	STR	7 1/4
PMSMB628R	22	STR	7 1/4

PMSMB620R includes:
Osteotome PMSMB621R-PMSMB628R and
Mallet PMSMB629R



LAMBOTTE Osteotome

Catalog Number	Tip Size (mm)	Tip Size (in.)	Blade	Length (in.)
PMSMB640R	COMPLETE SET		STR	
PMSMB641R	6	1/4	STR	9
PMSMB642R	13	1/2	STR	9
PMSMB643R	19	3/4	STR	9
PMSMB644R	25	1	STR	9
PMSMB645R	32	1 1/4	STR	9
PMSMB646R	38	1 1/2	STR	9
PMSMB650R	COMPLETE SET		CVD	
PMSMB651R	6	1/4	CVD	9
PMSMB652R	13	1/2	CVD	9
PMSMB653R	19	3/4	CVD	9
PMSMB654R	25	1	CVD	9
PMSMB655R	32	1 1/4	CVD	9
PMSMB656R	38	1 1/2	CVD	9



PMSMB640R-PMSMB646R

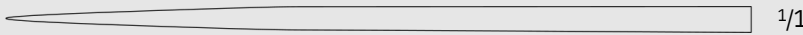

PMSMB640R-PMSMB646R



PMSMB650R-PMSMB656R

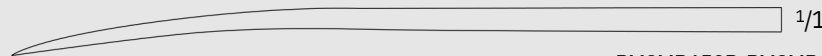

PMSMB650R-PMSMB656R

LAMBOTTE Osteotome

Catalog Number	Tip Size (mm)	Blade	Length (in.)
PMSFL650R	4	STR	9 5/8
PMSFL651R	8	STR	9 5/8
PMSFL652R	10	STR	9 5/8
PMSFL653R	13	STR	9 5/8
PMSFL654R	15	STR	9 5/8
PMSFL655R	18	STR	9 5/8
PMSFL656R	20	STR	9 5/8
PMSFL658R	25	STR	9 5/8
PMSFL659R	30	STR	9 5/8
PMSFL660R	38	STR	9 5/8
PMSFL661R	44	STR	9 5/8
PMSFL662R	50	STR	9 5/8
PMSFL781R	8	CVD	9 5/8
PMSFL783R	13	CVD	9 5/8
PMSFL785R	18	CVD	9 5/8
PMSFL788R	25	CVD	9 5/8
PMSFL789R	30	CVD	9 5/8
PMSFL790R	38	CVD	9 5/8



PMSFL650R-PMSFL662R

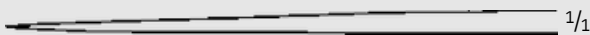

PMSFL650R-PMSFL662R



PMSFL781R-PMSFL790R

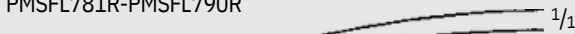

PMSFL781R-PMSFL790R

Orthopedics/Spine

Mallets



Mallet, PEEK

Catalog Number	Handle	Weight (gr)	Diameter (mm)	Length (in.)
PMSFL010	HARTPRESS	230	42	9 3/4
PMSFL011	HARTPRESS	315	50	9 3/4



Actual image color is blue

PMSFL010-PMSFL011

MEAD Mallet, Removable Discs, 180gr

Catalog Number	Description	Diameter (mm)	Length (in.)
PMSFL035R	COMPLETE	20	7 1/2
PMSFL034	SPARE DISCS, F/FL035R, 2/SET	20	

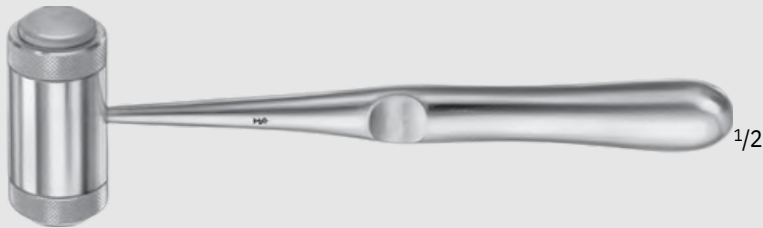

PMSFL035R

Mallet W/ Removable Nylon Discs, 135gr

Catalog Number	Description	Diameter (mm)	Length (in.)
PMSFL036R	COMPLETE	25	7 1/4
PMSFL037	NYLON SPARE DISCS, F/FL036R, 2/SET	25	

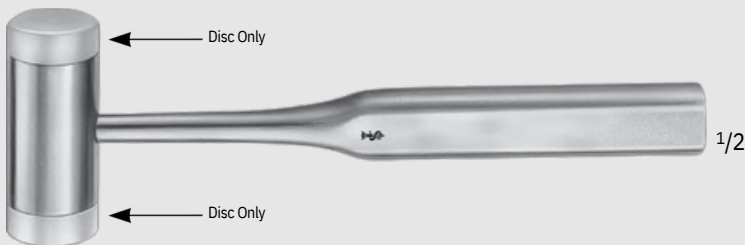

PMSFL036R

Mallet, 226gr

Catalog Number	Description	Diameter (mm)	Length (in.)
PMSMB629R	ONE SIDE NYLON, ONE SIDE METAL	26	7 1/4
PMSMB629200	REPLACEMENT NYLON DISC FOR MB629R MALLET HEAD		



PMSMB629R



PMSDF114R

Mallet, 155gr

Catalog Number	Diameter (mm)	Length (in.)
PMSDF114R	25	7 1/2



PMSUS142

Mallet, Copper

Catalog Number	Diameter (mm)	Length (in.)
PMSUS142	20	6 1/2



PMSMG583R

KIRK Mallet, 560gr

Catalog Number	Diameter (mm)	Length (in.)
PMSMG583R	35	7 1/4



Orthopedics/Spine

Mallets



PMSFL038R

COTTLE Mallet, Flat/Round, 235gr

Catalog Number	Diameter (mm)	Length (in.)
PMSFL038R	30	7 1/4



PMSFL044R

HAJEK Mallet, 140gr

Catalog Number	Diameter (mm)	Length (in.)
PMSFL044R	27	8 3/4



PMSFL055R

BERGMANN Mallet, 260gr

Catalog Number	Diameter (mm)	Length (in.)
PMSFL055R	30	9 1/4

PEEK

1/2



Mallet, 285gr, W/ Silicone Handle

Catalog Number	Diameter (mm)	Length (in.)
PMSFL059R	30 / 42	9 1/2



BERGMANN Mallet, 300gr, W/ Silicone Handle

Catalog Number	Diameter (mm)	Length (in.)
PMSFL060R	45	9 5/8



Orthopedic Mallet

Catalog Number	Diameter (mm)	Length (in.)
PMSMB630R	30	7 1/4
PMSMB631R	38	7 1/4

PMSMB630R: 1 LB Weight (485gr)
 PMSMB631R: 2 LB Weight (907gr)

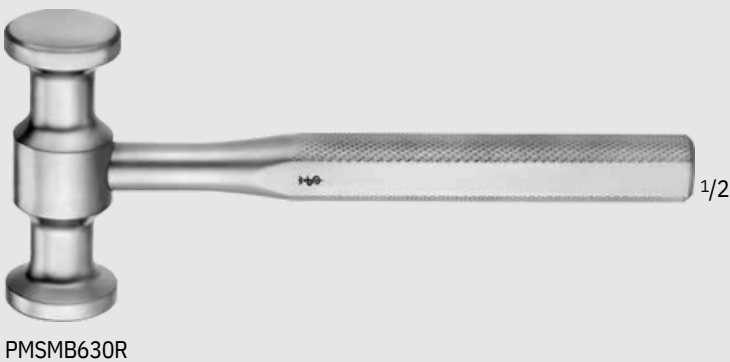

Orthopedics/Spine

Mallets



WAGNER Mallet Set, 130gr, W/ Silicone Handle

Catalog Number	Diameter (mm)	Length (in.)
PMSFL062	35	9 1/4

Set includes:
 1 PR Metal Discs PMSFL064R
 1 PR Plastic Discs PMSFL065
 1 Wrench PMSFL062/206



PMSFL062

215 gr
 1 Metal Disc, at
 1 Metal Disc, convex



PMSFL064R

30 gr
 1 Plastic Disc, at
 1 Plastic Disc, convex



PMSFL065

OMBREDANNE Mallet, 520gr, W/ Silicone Handle

Catalog Number	Diameter (mm)	Length (in.)
PMSFL066R	40	9 1/2



PMSFL066R

HEATH Copper Head Mallet, 725gr, W/ Silicone Handle

Catalog Number	Diameter (mm)	Length (in.)
PMSFL068R	40	9 1/4



PMSFL068R



PMSMG095R

HEATH Mallet, 823gr

Catalog Number	Diameter (mm)	Size	Length (in.)
PMSMG095R	40	1.8 lbs	7 1/4



PMSFL090R

Bone Graft Tamper

Catalog Number	Diameter (mm)	Length (in.)
PMSFL090R	12	7 7/8



PMSFL090R



PMSMB796R-PMSMB800R



PMSMB796R



PMSMB798R



PMSMB800R

Bone Tamp

Catalog Number	Diameter (mm)	Length (in.)
PMSMB796R	2	6 1/4
PMSMB798R	4	6 1/4
PMSMB800R	6	6 1/4
PMSMB801R	8	6 1/4
PMSMB802R	10	6 1/4



PMSMB801R

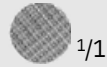

PMSMB801R



PMSMB802R



PMSMB802R

SYPERT Spinal Impactor, W/ HART-PRESS Handle

Catalog Number	Tip Size (mm)	Length (in.)
PMSFG093R	3 x 8	11 1/2
PMSFG094R	4 x 10	11 1/2
PMSFG095R	5 x 15	11 1/2
PMSFG096R	6 x 20	11 1/2



PMSFG093R-PMSFG096R



PMSFG093R



PMSFG094R



PMSFG095R



PMSFG096R



ORTHO SPINE

INCHES

Orthopedics/Spine

Bone Impactor

COBB Bone Impactor

Catalog Number	Tip Size (mm)	Length (in.)
PMSMB545R	3 x 12	11 1/4





PMSG021R

RALKS Hand Drill, Cannulated

Catalog Number	Length (in.)
PMSG021R	6 1/4



Orthopedics/Spine

Drills, Burrs and Reamers



CHAMPIONNIÈRE Bone Drill

Catalog Number	Length (in.)
PMSFR110R	6 3/4



Awl/Reamer

Catalog Number	Length (in.)
PMSFR118R	6

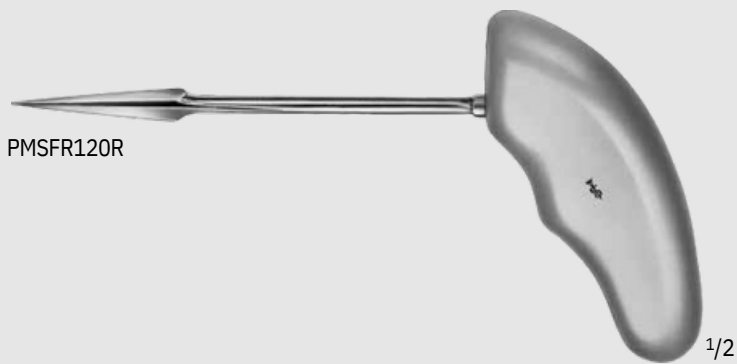

Reamer

Catalog Number	Length (in.)
PMSFR120R	7





PMSFR125R

PERTHES Reamer

Catalog Number	Length (in.)
PMSFR125R	8 1/2

1/2



PMSFR140R-PMSFR141R

Bone Biopsy Trephine

Catalog Number	Diameter (mm)	Length (in.)
PMSFR140R	3.9 / 5	6 1/4
PMSFR141R	6.4 / 8	6 1/4

1/2



1/1

PMSFR140R



1/1

PMSFR141R

Orthopedics/Spine

Curettes



PMSvFK845R

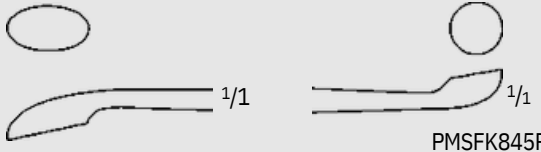

PMSFK845R



PMSFK846R

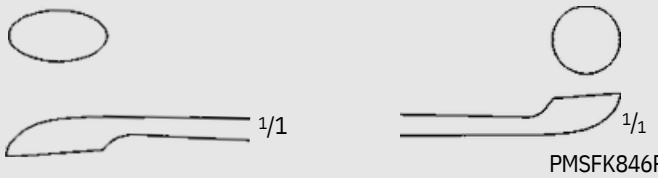

PMSFK846R



PMSFK848R

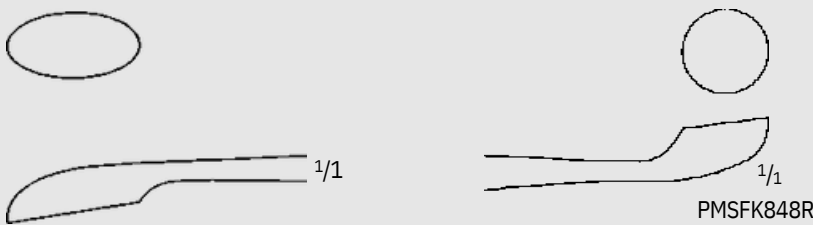

PMSFK848R



PMSFK850R

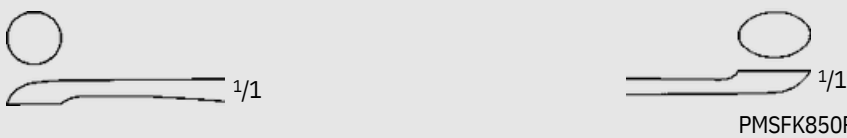

PMSFK850R

Bone Curette, Double Ended

Catalog Number	Tip Size (mm)	Length (in.)
PMSFK845R	6 / 7	5 1/8
PMSFK846R	7 / 8	6 1/4
PMSFK848R	8 / 11	7 7/8
PMSFK850R	7 / 6	8 1/4



PMSFK658R-PMSFK659R

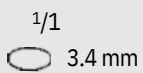

PMSFK658R

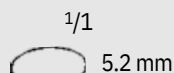

PMSFK659R

WILLIGER Bone Curette

Catalog Number	Tip Size (#)	Tip Size (mm)	Length (in.)
PMSFK658R	00	3.4	6 3/4
PMSFK659R	1	5.2	6 3/4

ORTHO
SPINE

MILLIMETERS

BRUNS Curette, Round

Catalog Number	Tip Size (#)	Tip Size (mm)	Length (in.)
PMSFK611R	000	3	6 1/2
PMSFK612R	00	4	6 1/2
PMSFK613R	0	5	6 1/2
PMSFK614R	1	6	6 1/2
PMSFK615R	2	8	6 1/2
PMSFK616R	3	10	6 1/2
PMSFK617R	4	12	6 1/2



PMSFK611R-PMSFK617R



1/1
3 mm
PMSFK611R

1/1
4 mm
PMSFK612R

1/1
5 mm
PMSFK613R

1/1
6 mm
PMSFK614R

1/1
8 mm
PMSFK615R

1/1
10 mm
PMSFK616R

1/1
12 mm
PMSFK617R

SCHEDE Curette

Catalog Number	Tip Size (#)	Tip Size (mm)	Length (in.)
PMSFK621R	000	2.5	6 3/4
PMSFK622R	00	3.4	6 3/4
PMSFK623R	0	4.2	6 3/4
PMSFK624R	1	5.2	6 3/4
PMSFK625R	2	6.3	6 3/4
PMSFK626R	3	7.4	6 3/4
PMSFK627R	4	8.0	6 3/4



PMSFK621R-PMSFK627R

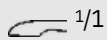

1/1
2.5 mm
PMSFK621R

1/1
3.4 mm
PMSFK622R

1/1
4.2 mm
PMSFK623R

1/1
5.2 mm
PMSFK624R

1/1
6.3 mm
PMSFK625R

1/1
7.4 mm
PMSFK626R

1/1
8 mm
PMSFK627R

VOLKMANN Curette

Catalog Number	Tip Size (#)	Tip Size (mm)	Length (in.)
PMSFK630R	0000	2.8	6 3/4
PMSFK631R	000	3.6	6 3/4
PMSFK632R	00	4.4	6 3/4
PMSFK633R	0	5.2	6 3/4
PMSFK634R	1	6.8	6 3/4
PMSFK635R	2	8.5	6 3/4
PMSFK636R	3	10.0	6 3/4
PMSFK637R	4	11.5	6 3/4
PMSFK638R	5	13.0	6 3/4
PMSFK639R	6	14.5	6 3/4



PMSFK630R-PMSFK639R

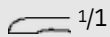

1/1
2.8 mm
PMSFK630R

1/1
3.6 mm
PMSFK631R

1/1
4.4 mm
PMSFK632R

1/1
5.2 mm
PMSFK633R

1/1
6.8 mm
PMSFK634R

1/1
8.5 mm
PMSFK635R

1/1
10 mm
PMSFK636R

1/1
11.5 mm
PMSFK637R

1/1
13 mm
PMSFK638R

1/1
14.5 mm
PMSFK639R

Orthopedics/Spine

Curettes



PMSFK662R-PMSFK665R

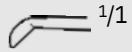

1/1
○ 2.8 mm
PMSFK662R

1/1
○ 3.6 mm
PMSFK663R

1/1
○ 4.4 mm
PMSFK664R

1/1
○ 5.2 mm
PMSFK665R

DAUBENSPECK Bone Curette

Catalog Number	Tip Size (#)	Tip Size (mm)	Length (in.)
PMSFK662R	0000	2.8	7 7/8
PMSFK663R	000	3.6	7 7/8
PMSFK664R	00	4.4	7 7/8
PMSFK665R	0	5.2	7 7/8



PMSFK675R-PMSFK679R



1/1
○ 1.8 mm
PMSFK675R

1/1
○ 2.0 mm
PMSFK676R

1/1
○ 2.4 mm
PMSFK677R

1/1
○ 2.6 mm
PMSFK678R

1/1
○ 2.8 mm
PMSFK679R

LEMPERT Bone Curette

Catalog Number	Tip Size (mm)	Length (in.)
PMSFK675R	1.8	8 1/2
PMSFK676R	2.0	8 1/2
PMSFK677R	2.4	8 1/2
PMSFK678R	2.6	8 1/2
PMSFK679R	2.8	8 1/2



PMSMD565-PMSMD567



1/1
○ PMSMD565

EPSTEIN Spinal Curette

Catalog Number	Tip Size (mm)	Size (#)	Length (in.)
PMSMD565	2.0	000	8
PMSMD566	2.5	00	8
PMSMD567	3.0	0	8



SCOVILLE Bone Curette

Catalog Number	Tip Size (#)	Tip Size (mm)	Tip	Length (in.)
PMSFK702R	000	3.6	FWD STR	9 3/4
PMSFK703R	00	4.4	FWD STR	9 3/4
PMSFK704R	0	5.2	FWD STR	9 3/4
PMSFK705R	1	6.8	FWD STR	9 3/4
PMSFK712R	000	3.6	FWD ANG	9 3/4
PMSFK713R	00	4.4	FWD ANG	9 3/4
PMSFK714R	0	5.2	FWD ANG	9 3/4
PMSFK715R	1	6.8	FWD ANG	9 3/4



PMSFK702R-PMSFK715R



1/1

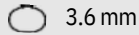

PMSFK702R



1/1

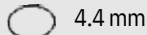

PMSFK703R

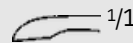

1/1



PMSFK704R



1/1



PMSFK705R

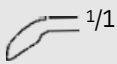

1/1

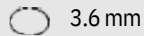

PMSFK712R

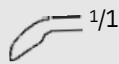

1/1

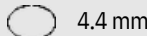

PMSFK713R

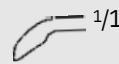

1/1

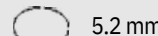

PMSFK714R

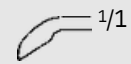

1/1



PMSFK715R

BUSHE Bone Curette

Catalog Number	Tip Size (mm)	Tip	Length (in.)
PMSFK723R	3.0	REV ANG	9 3/4
PMSFK724R	4.0	REV ANG	9 3/4
PMSFK725R	5.0	REV ANG	9 3/4



PMSFK723R-PMSFK725R



1/1

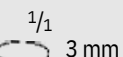

PMSFK723R



1/1

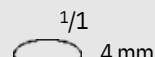

PMSFK724R



1/1

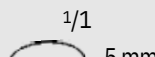

PMSFK725R



ORTHO SPINE

INCHES

Orthopedics/Spine

Curettes

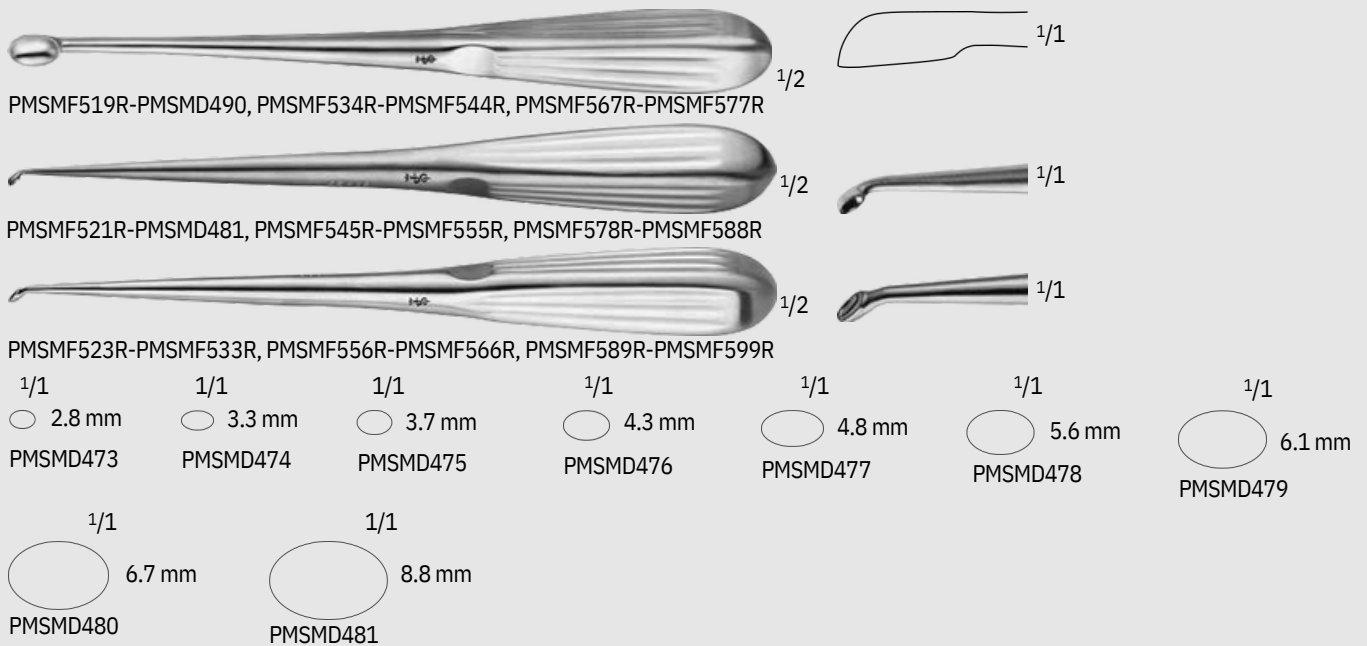

BRUNS Spinal Curette

Catalog Number	Tip Size (#)	Tip	Length (in.)
PMSMF519R	00000	STR	8
PMSMF520R	0000	STR	8
PMSMD482	000	STR	8
PMSMD483	00	STR	8
PMSMD484	0	STR	8
PMSMD485	1	STR	8
PMSMD486	2	STR	8
PMSMD487	3	STR	8
PMSMD488	4	STR	8
PMSMD489	5	STR	8
PMSMD490	6	STR	8
PMSMF521R	00000	FWD ANG	8
PMSMF522R	0000	FWD ANG	8
PMSMD473	000	FWD ANG	8
PMSMD474	00	FWD ANG	8
PMSMD475	0	FWD ANG	8
PMSMD476	1	FWD ANG	8
PMSMD477	2	FWD ANG	8
PMSMD478	3	FWD ANG	8
PMSMD479	4	FWD ANG	8
PMSMD480	5	FWD ANG	8
PMSMD481	6	FWD ANG	8
PMSMF523R	00000	REV ANG	8
PMSMF524R	0000	REV ANG	8
PMSMF525R	000	REV ANG	8
PMSMF526R	00	REV ANG	8
PMSMF527R	0	REV ANG	8
PMSMF528R	1	REV ANG	8
PMSMF529R	2	REV ANG	8
PMSMF530R	3	REV ANG	8
PMSMF531R	4	REV ANG	8
PMSMF532R	5	REV ANG	8
PMSMF533R	6	REV ANG	8

Catalog Number	Tip Size (#)	Tip	Length (in.)
PMSMF534R	00000	STR	9
PMSMF535R	0000	STR	9
PMSMF536R	000	STR	9
PMSMF537R	00	STR	9
PMSMF538R	0	STR	9
PMSMF539R	1	STR	9
PMSMF540R	2	STR	9
PMSMF541R	3	STR	9
PMSMF542R	4	STR	9
PMSMF543R	5	STR	9
PMSMF544R	6	STR	9
PMSMF545R	00000	FWD ANG	9
PMSMF546R	0000	FWD ANG	9
PMSMF547R	000	FWD ANG	9
PMSMF548R	00	FWD ANG	9
PMSMF549R	0	FWD ANG	9
PMSMF550R	1	FWD ANG	9
PMSMF551R	2	FWD ANG	9
PMSMF552R	3	FWD ANG	9
PMSMF553R	4	FWD ANG	9
PMSMF554R	5	FWD ANG	9
PMSMF555R	6	FWD ANG	9
PMSMF556R	00000	REV ANG	9
PMSMF557R	0000	REV ANG	9
PMSMF558R	000	REV ANG	9
PMSMF559R	00	REV ANG	9
PMSMF560R	0	REV ANG	9
PMSMF561R	1	REV ANG	9
PMSMF562R	2	REV ANG	9
PMSMF563R	3	REV ANG	9
PMSMF564R	4	REV ANG	9
PMSMF565R	5	REV ANG	9
PMSMF566R	6	REV ANG	9

Catalog Number	Tip Size (#)	Tip	Length (in.)
PMSMF567R	00000	STR	12
PMSMF568R	0000	STR	12
PMSMF569R	000	STR	12
PMSMF570R	00	STR	12
PMSMF571R	0	STR	12
PMSMF572R	1	STR	12
PMSMF573R	2	STR	12
PMSMF574R	3	STR	12
PMSMF575R	4	STR	12
PMSMF576R	5	STR	12
PMSMF577R	6	STR	12
PMSMF578R	00000	FWD ANG	12
PMSMF579R	0000	FWD ANG	12
PMSMF580R	000	FWD ANG	12
PMSMF581R	00	FWD ANG	12
PMSMF582R	0	FWD ANG	12
PMSMF583R	1	FWD ANG	12
PMSMF584R	2	FWD ANG	12
PMSMF585R	3	FWD ANG	12
PMSMF586R	4	FWD ANG	12
PMSMF587R	5	FWD ANG	12
PMSMF588R	6	FWD ANG	12
PMSMF589R	00000	REV ANG	12
PMSMF590R	0000	REV ANG	12
PMSMF591R	000	REV ANG	12
PMSMF592R	00	REV ANG	12
PMSMF593R	0	REV ANG	12
PMSMF594R	1	REV ANG	12
PMSMF595R	2	REV ANG	12
PMSMF596R	3	REV ANG	12
PMSMF597R	4	REV ANG	12
PMSMF598R	5	REV ANG	12
PMSMF599R	6	REV ANG	12

ORTHO
SPINE



PMSMB872R-PMSMB880R

BRUNS Curette

Catalog Number	Tip Size (#)	Tip Size (mm)	Tip	Length (in.)
PMSMB872R	000	2.0	STR	9
PMSMB873R	00	2.5	STR	9
PMSMB874R	0	3.3	STR	9
PMSMB875R	1	3.8	STR	9
PMSMB876R	2	4.8	STR	9
PMSMB877R	3	5.3	STR	9
PMSMB878R	4	6.0	STR	9
PMSMB879R	5	6.7	STR	9
PMSMB880R	6	7.3	STR	9

1/1

○ 2.0 mm
PMSMB872R

1/1

○ 2.5 mm
PMSMB873R

1/1

○ 3.3 mm
PMSMB874R

1/1

○ 3.8 mm
PMSMB875R

1/1

○ 4.8 mm
PMSMB876R

1/1

○ 5.3 mm
PMSMB877R

1/1

○ 6.0 mm
PMSMB878R

1/1

○ 6.7 mm
PMSMB879R

1/1

○ 7.3 mm
PMSMB880R



PMSFK688R-PMSFK690R

SIMON Bone Curette

Catalog Number	Tip Size (#)	Tip Size (mm)	Length (in.)
PMSFK688R	000	3.6	9 1/4
PMSFK689R	00	4.4	9 1/4
PMSFK690R	0	5.2	9 1/4



1/1

1/1

○ 3.6 mm
PMSFK688R

1/1

○ 4.4 mm
PMSFK689R

1/1

○ 5.2 mm
PMSFK690R



PMSMB415R-PMSMB417R

HIBBS Curette

Catalog Number	Tip	Length (in.)
PMSMB415R	SMALL	8
PMSMB416R	MEDIUM	8
PMSMB417R	LARGE	8

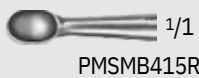

1/1

PMSMB415R



1/1

PMSMB416R



1/1

PMSMB417R

ORTHO SPINE



INCHES

Orthopedics/Spine

Curettes

Bone Curette, Long, W/ PEEK Handle

Catalog Number	Tip Size (#)	Tip Size (mm)	Length (in.)
PMSFK666R	00	4.4	10 5/8
PMSFK668R	1	6.8	10 5/8
PMSFK670R	2	8.5	10 5/8
PMSFK672R	3	10.0	10 5/8



PMSFK666R-PMSFK672R

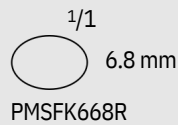
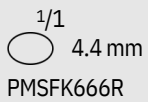
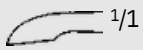

CASPAR Curette, W/ PEEK Handle

Catalog Number	Tip Size (#)	Tip Size (mm)	Blade	Length (in.)
PMSFK773R	000	3.6	STR	8 3/4
PMSFK774R	00	4.4	STR	8 3/4
PMSFK775R	0	5.2	STR	8 3/4
PMSFK783R	000	3.6	CVD	8 3/4
PMSFK784R	00	4.4	CVD	8 3/4
PMSFK785R	0	5.2	CVD	8 3/4



PMSFK773R-PMSFK775R

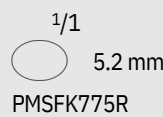
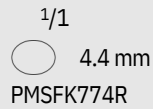
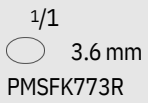
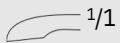

PMSFK783R-PMSFK785R

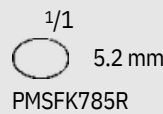
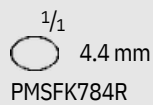
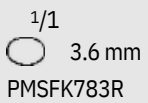
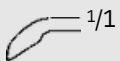

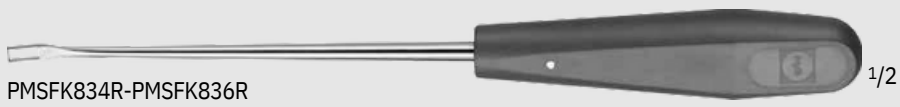

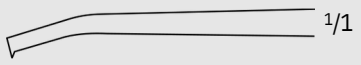

CASPAR Curette, W/ PEEK Handle

Catalog Number	Tip Size (mm)	Tip	Length (in.)
PMSFK834R	4	SQUARE	8 3/4
PMSFK835R	5	SQUARE	8 3/4
PMSFK836R	6	SQUARE	8 3/4

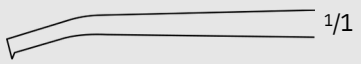

4 mm  1/1
PMSFK834R



5 mm  1/1
PMSFK835R

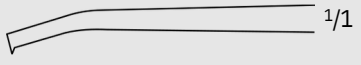

6 mm  1/1
PMSFK836R



Orthopedics/Spine

Curettes

CASPAR Bone Curette, Toothed

Catalog Number	Tip Size (mm)	Tip	Length (in.)
PMSFK854R	4.0	SQUARE	9 3/4
PMSFK855R	5.0	SQUARE	9 3/4



PMSFK854R-PMSFK855R

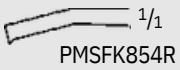

PMSFK854R

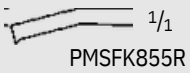

PMSFK855R

CASPAR Bone Curette, Toothed

Catalog Number	Tip Size (mm)	Tip	Length (in.)
PMSFK863R	3.0	SQUARE, ANG	10 5/8
PMSFK864R	4.0	SQUARE, ANG	10 5/8



PMSFK863R-PMSFK864R

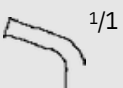

PMSFK863R



PMSFK864R

ORTHO
SPINE

MILLIMETERS

COBB Curette

Catalog Number	Tip Size (#)	Tip Size (mm)	Tip	Length (in.)
PMSFK581R	000	2.0	STR	11
PMSFK582R	00	2.5	STR	11
PMSFK583R	0	3.0	STR	11
PMSFK584R	1	3.5	STR	11
PMSFK585R	2	4.5	STR	11
PMSFK586R	3	5.5	STR	11
PMSFK587R	4	7.5	STR	11
PMSFK588R	5	8.5	STR	11
PMSFK589R	6	10.0	STR	11
PMSFK591R	000	2.0	ANG	11
PMSFK592R	00	2.5	ANG	11
PMSFK593R	0	3.0	ANG	11
PMSFK594R	1	3.5	ANG	11
PMSFK595R	2	4.5	ANG	11
PMSFK596R	3	5.5	ANG	11
PMSFK597R	4	7.5	ANG	11
PMSFK598R	5	8.5	ANG	11
PMSFK599R	6	10.0	ANG	11

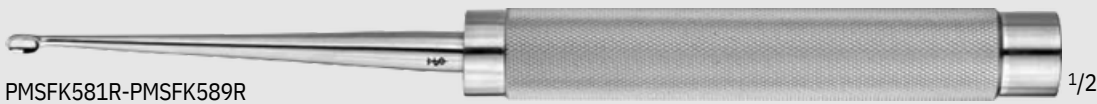

^{1/1}
 2.0 mm
 ^{1/1}
 2.5 mm
 ^{1/1}
 3.0 mm
 ^{1/1}
 3.5 mm
 ^{1/1}
 4.5 mm
 PMSFK581R, PMSFK591R PMSFK582R, PMSFK592R PMSFK583R, PMSFK593R PMSFK584R, PMSFK594R PMSFK585R, PMSFK595R

^{1/1}
 5.5 mm
 ^{1/1}
 7.5 mm
 ^{1/1}
 8.5 mm
 ^{1/1}
 10.0 mm
 PMSFK586R, PMSFK596R PMSFK587R, PMSFK597R PMSFK588R, PMSFK598R PMSFK589R, PMSFK599R



Orthopedics/Spine

Curettes

Colored Cervical Curette

Catalog Number	Tip Size (#)	Tip	Color	Length (in.)
PMSMD216R	000000	STR	RED	10
PMSMD217R	00000	STR	SILVER	10
PMSMD218R	0000	STR	PURPLE	10
PMSMD219R	000	STR	TURQUOISE	10
PMSMD220R	00	STR	GOLD	10
PMSMD221R	0	STR	GREEN	10
PMSMD222R	1	STR	ORANGE	10
PMSMD223R	2	STR	BLUE	10
PMSMD224R	3	STR	GRAY	10
PMSMD225R	4	STR	BLACK	10
PMSMD226R	5	STR	BLACK	10
PMSMD227R	6	STR	BLACK	10
PMSMD234R	000000	ANG	RED	10
PMSMD235R	00000	ANG	SILVER	10
PMSMD236R	0000	ANG	PURPLE	10
PMSMD237R	000	ANG	TURQUOISE	10
PMSMD238R	00	ANG	GOLD	10
PMSMD239R	0	ANG	GREEN	10
PMSMD240R	1	ANG	ORANGE	10
PMSMD241R	2	ANG	BLUE	10
PMSMD242R	3	ANG	GRAY	10
PMSMD243R	4	ANG	BLACK	10
PMSMD244R	5	ANG	BLACK	10
PMSMD245R	6	ANG	BLACK	10

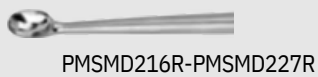

Colored Cervical Curette

Catalog Number	Tip Size (#)	Tip	Color	Length (in.)
PMSMD309R	000000	REVERSE ANG	RED	10
PMSMD310R	00000	REVERSE ANG	SILVER	10
PMSMD311R	0000	REVERSE ANG	PURPLE	10
PMSMD312R	000	REVERSE ANG	TURQUOISE	10
PMSMD313R	00	REVERSE ANG	GOLD	10
PMSMD314R	0	REVERSE ANG	GREEN	10
PMSMD315R	1	REVERSE ANG	ORANGE	10
PMSMD316R	2	REVERSE ANG	BLUE	10
PMSMD317R	3	REVERSE ANG	GRAY	10
PMSMD318R	4	REVERSE ANG	BLACK	10
PMSMD319R	5	REVERSE ANG	BLACK	10
PMSMD320R	6	REVERSE ANG	BLACK	10
PMSMD383R	000000	ANG 90°	RED	10
PMSMD384R	00000	ANG 90°	SILVER	10
PMSMD385R	0000	ANG 90°	PURPLE	10
PMSMD386R	000	ANG 90°	TURQUOISE	10
PMSMD387R	00	ANG 90°	GOLD	10
PMSMD388R	0	ANG 90°	GREEN	10
PMSMD389R	1	ANG 90°	ORANGE	10
PMSMD390R	2	ANG 90°	BLUE	10
PMSMD391R	3	ANG 90°	GRAY	10
PMSMD392R	4	ANG 90°	BLACK	10
PMSMD393R	5	ANG 90°	BLACK	10
PMSMD394R	6	ANG 90°	BLACK	10



PMSMD309R-PMSMD320R

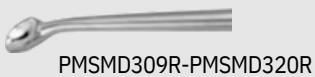

PMSMD309R-PMSMD320R



PMSMD383R-PMSMD394R



PMSMD383R-PMSMD394R

ORTHO
SPINE



Orthopedics/Spine

Curettes

Colored Lumbar Curette

Catalog Number	Tip Size (#)	Tip	Color	Length (in.)
PMSMD500R	000000	STR	RED	13 3/4
PMSMD501R	00000	STR	SILVER	13 3/4
PMSMD502R	0000	STR	PURPLE	13 3/4
PMSMD503R	000	STR	TURQUOISE	13 3/4
PMSMD504R	00	STR	GOLD	13 3/4
PMSMD505R	0	STR	GREEN	13 3/4
PMSMD506R	1	STR	ORANGE	13 3/4
PMSMD507R	2	STR	BLUE	13 3/4
PMSMD508R	3	STR	GRAY	13 3/4
PMSMD509R	4	STR	BLACK	13 3/4
PMSMD510R	5	STR	BLACK	13 3/4
PMSMD511R	6	STR	BLACK	13 3/4
MD620R	000000	ANG	RED	13 3/4
PMSMD621R	00000	ANG	SILVER	13 3/4
PMSMD622R	0000	ANG	PURPLE	13 3/4
PMSMD623R	000	ANG	TURQUOISE	13 3/4
PMSMD624R	00	ANG	GOLD	13 3/4
PMSMD625R	0	ANG	GREEN	13 3/4
PMSMD626R	1	ANG	ORANGE	13 3/4
PMSMD627R	2	ANG	BLUE	13 3/4
PMSMD628R	3	ANG	GRAY	13 3/4
PMSMD629R	4	ANG	BLACK	13 3/4
PMSMD630R	5	ANG	BLACK	13 3/4
PMSMD631R	6	ANG	BLACK	13 3/4
PMSMD632R	000000	REVERSE ANG	RED	13 3/4
PMSMD633R	00000	REVERSE ANG	SILVER	13 3/4
PMSMD634R	0000	REVERSE ANG	PURPLE	13 3/4
PMSMD635R	000	REVERSE ANG	TURQUOISE	13 3/4
PMSMD636R	00	REVERSE ANG	GOLD	13 3/4
PMSMD637R	0	REVERSE ANG	GREEN	13 3/4
PMSMD638R	1	REVERSE ANG	ORANGE	13 3/4
PMSMD639R	2	REVERSE ANG	BLUE	13 3/4
PMSMD640R	3	REVERSE ANG	GRAY	13 3/4
PMSMD641R	4	REVERSE ANG	BLACK	13 3/4
PMSMD642R	5	REVERSE ANG	BLACK	13 3/4
PMSMD643R	6	REVERSE ANG	BLACK	13 3/4

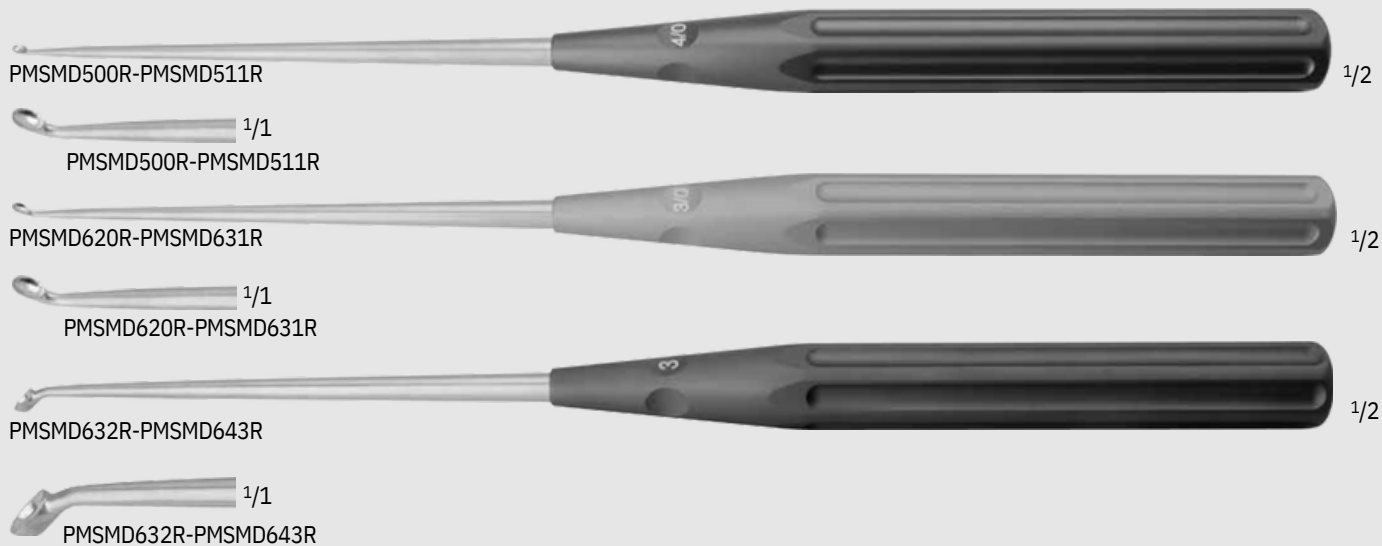

ORTHO
SPINE

Bayonet Curette

Catalog Number	Tip	Tip Size (#)	Length (in.)
PMSMD660R	STR	0	9
PMSMD661R	STR	00	9
PMSMD662R	STR	000	9
PMSMD663R	STR	0000	9
PMSMD664R	STR	00000	9
PMSMD655R	REVERSE ANG UP	0	9
PMSMD656R	REVERSE ANG UP	00	9
PMSMD657R	REVERSE ANG UP	000	9
PMSMD658R	REVERSE ANG UP	0000	9
PMSMD659R	REVERSE ANG UP	00000	9
PMSMD665R	REVERSE ANG DOWN	0	9
PMSMD666R	REVERSE ANG DOWN	00	9
PMSMD667R	REVERSE ANG DOWN	000	9
PMSMD668R	REVERSE ANG DOWN	0000	9
PMSMD669R	REVERSE ANG DOWN	00000	9

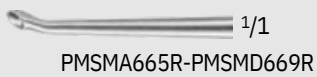
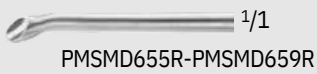
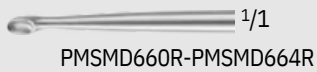

ORTHO
SPINE

Orthopedics/Spine

Curettes

Black Handle Curette

Catalog Number	Tip	Tip Size (#)	Handle	Length (in.)
PMSMN012R	STR	000	8 1/2	13 1/4
PMSMN013R	STR	00	8 1/2	13 1/4
PMSMN014R	STR	0	8 1/2	13 1/4
PMSMN015R	STR	1	8 1/2	13 1/4
PMSMN016R	STR	2	8 1/2	13 1/4
PMSMN017R	STR	3	8 1/2	13 1/4
PMSMN018R	STR	4	8 1/2	13 1/4
PMSMN019R	STR	5	8 1/2	13 1/4
PMSMN020R	STR	6	8 1/2	13 1/4
PMSMN021R	STR	7	8 1/2	13 1/4
PMSMN022R	ANG	000	8 1/2	13 1/4
PMSMN023R	ANG	00	8 1/2	13 1/4
PMSMN024R	ANG	0	8 1/2	13 1/4
PMSMN025R	ANG	1	8 1/2	13 1/4
PMSMN026R	ANG	2	8 1/2	13 1/4
PMSMN027R	ANG	3	8 1/2	13 1/4
PMSMN028R	ANG	4	8 1/2	13 1/4
PMSMN029R	ANG	5	8 1/2	13 1/4
PMSMN030R	ANG	6	8 1/2	13 1/4
PMSMN031R	ANG	7	8 1/2	13 1/4
PMSMN032R	REVERSE ANG	000	8 1/2	13 1/4
PMSMN033R	REVERSE ANG	00	8 1/2	13 1/4
PMSMN034R	REVERSE ANG	0	8 1/2	13 1/4
PMSMN035R	REVERSE ANG	1	8 1/2	13 1/4
PMSMN036R	REVERSE ANG	2	8 1/2	13 1/4
PMSMN037R	REVERSE ANG	3	8 1/2	13 1/4
PMSMN038R	REVERSE ANG	4	8 1/2	13 1/4
PMSMN039R	REVERSE ANG	5	8 1/2	13 1/4
PMSMN040R	REVERSE ANG	6	8 1/2	13 1/4
PMSMN041R	REVERSE ANG	7	8 1/2	13 1/4



PMSMN012R-PMSMN021R



PMSMN022R-PMSMN031R



PMSMN032R-PMSMN041R



XL Black Handled Curette

Catalog Number	Tip	Tip Size (#)	Handle	Length (in.)
PMSMN042R	STR	000	9	15
PMSMN043R	STR	00	9	15
PMSMN044R	STR	0	9	15
PMSMN045R	STR	1	9	15
PMSMN046R	STR	2	9	15
PMSMN047R	STR	3	9	15
PMSMN048R	STR	4	9	15
PMSMN049R	STR	5	9	15
PMSMN050R	STR	6	9	15
PMSMN051R	STR	7	9	15
PMSMN052R	ANG	000	9	15
PMSMN053R	ANG	00	0	15
PMSMN054R	ANG	0	0	15
PMSMN055R	ANG	1	9	15
PMSMN056R	ANG	2	9	15
PMSMN057R	ANG	3	9	15
PMSMN058R	ANG	4	9	15
PMSMN059R	ANG	5	9	15
PMSMN060R	ANG	6	9	15
PMSMN061R	ANG	7	9	15
PMSMN062R	REVERSE ANG	000	9	15
PMSMN063R	REVERSE ANG	00	9	15
PMSMN064R	REVERSE ANG	0	9	15
PMSMN065R	REVERSE ANG	1	9	15
PMSMN066R	REVERSE ANG	2	9	15
PMSMN067R	REVERSE ANG	3	9	15
PMSMN068R	REVERSE ANG	4	9	15
PMSMN069R	REVERSE ANG	5	9	15
PMSMN070R	REVERSE ANG	6	9	15
PMSMN071R	REVERSE ANG	7	9	15



PMSMN042R-PMSMN051R



PMSMN052R-PMSMN061R



PMSMN062R-PMSMN071R



Orthopedics/Spine

Curettes and Microdissecting Instruments

Micro Pro le Instruments

Catalog Number	Description	Tip Size (#)	Tip	Length (in.)
PMSMN087R	DISSECTOR	3 MM	STR	10 1/4
PMSMN088R	DISSECTOR	5 MM	STR	10 1/4
PMSMN077R	CURETTE	1	ANG	10 1/4
PMSMN079R	CURETTE	2	ANG	10 1/4
PMSMN081R	CURETTE	3	ANG	10 1/4
PMSMN083R	CURETTE	4	ANG	10 1/4
PMSMN085R	CURETTE	5	ANG	10 1/4
PMSMN078R	CURETTE	1	REV-ANG	10 1/4
PMSMN080R	CURETTE	2	REV-ANG	10 1/4
PMSMN082R	CURETTE	3	REV-ANG	10 1/4
PMSMN084R	CURETTE	4	REV-ANG	10 1/4
PMSMN086R	CURETTE	5	REV-ANG	10 1/4

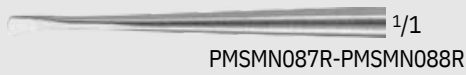

Orthopedics/Spine

Microdiscectomy Instruments

Storage Case for Microdiscectomy Instruments

Catalog Number
PMSMF320

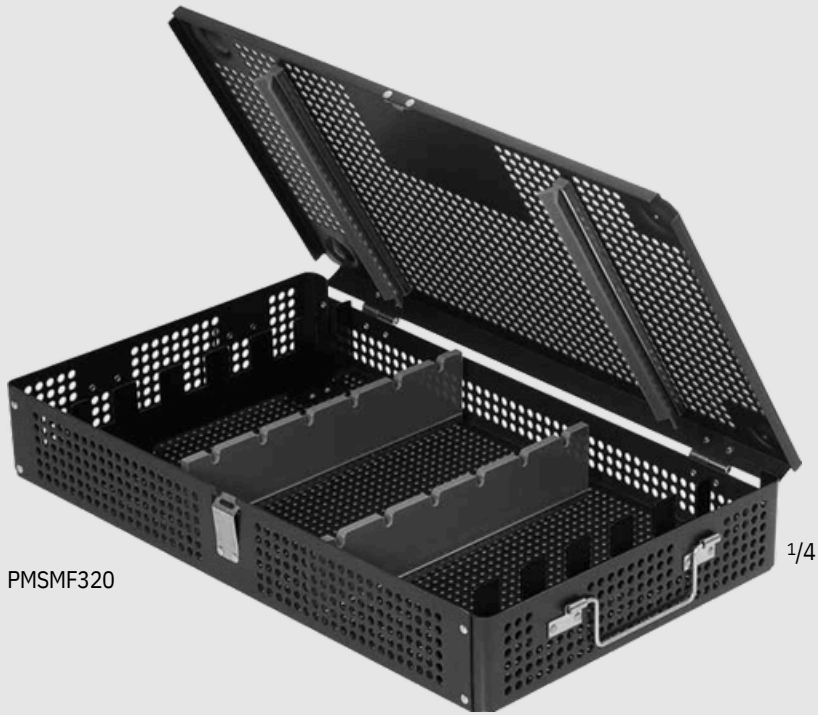

PMSMF320

1/4



ORTHO
SPINE



PMSFB141R-PMSFB143R

1/2



PMSFB141R

1/1



PMSFB142R

1/1



PMSFB143R

1/1

LEMMON Intima Dissector

Catalog Number	Tip	Length (in.)
PMSFB141R	SLIGHT-CVD	6 1/2
PMSFB142R	CVD	6 1/2
PMSFB143R	HEAVY-CVD	6 1/2



PMSMB456R

1/2



PMSMB456R

1/1

BUNNELL Dissecting Probe

Catalog Number	Tip	Length (in.)
PMSMB456R	ANG	5 1/2



PMSFK292R-PMSFK293R

1/2



2 mm

1/1

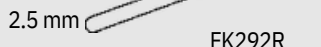

2.5 mm

FK292R

1/1



2 mm

1/1

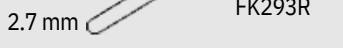

2.7 mm

FK293R

1/1

WATSON-CHEYNE Dissector, Double Ended

Catalog Number	Blade Size (mm)	Length (in.)
PMSFK292R	2 / 2.5	5 1/8
PMSFK293R	2 / 2.7	7 1/2



Orthopedics/Spine

Rongeurs

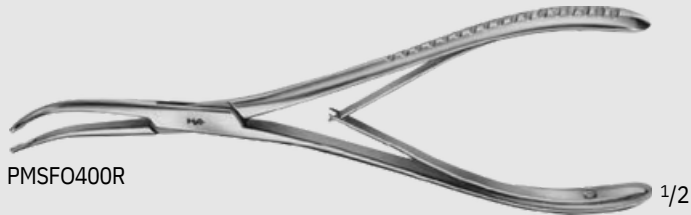
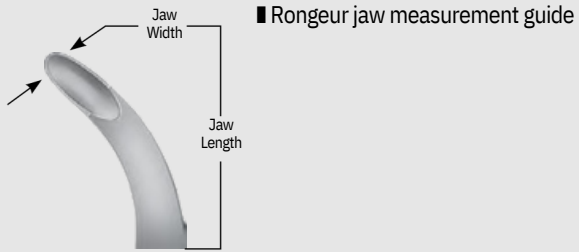

STELLBRINK Synovectomy Rongeur

Catalog Number	Jaw Size (mm)	Jaw	Length (in.)
PMSFO399R	2.0 x 39.5	SLIGHT-CVD	6 7/8
PMSFO400R	2 x 33	CVD	6 3/4



Synovectomy Rongeur

Catalog Number	Jaw Size (mm)	Jaw	Length (in.)
PMSFO599R	1.8 x 24	CVD	5 1/8



FRIEDMANN Micro Rongeur

Catalog Number	Jaw Size (mm)	Jaw	Length (in.)
PMSFO406R	1.3 x 19	STR	5 1/2
PMSFO407R	1.3 x 20	CVD	5 1/2

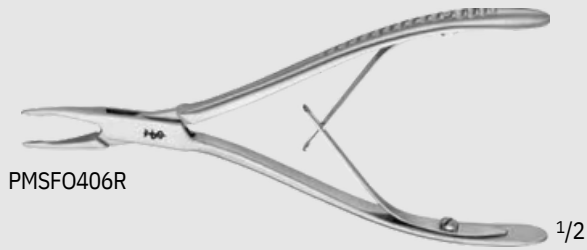

PMSFO406R

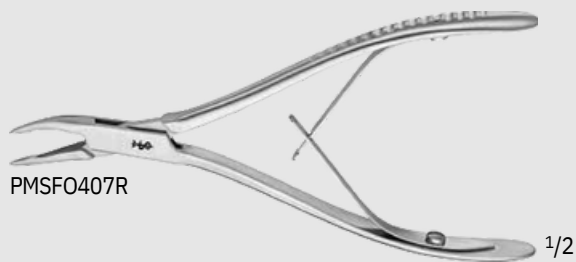

LUER-FRIEDMANN Bone Rongeur

Catalog Number	Jaw Size (mm)	Jaw	Length (in.)
PMSFO409R	2.2 x 22	CVD	5 3/4

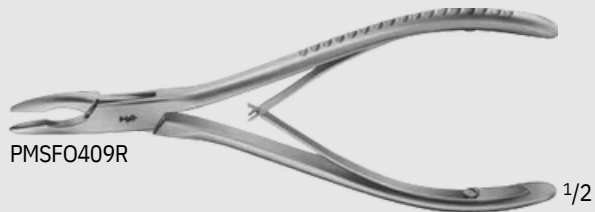

Bone Rongeur

Catalog Number	Jaw Size (mm)	Jaw	Length (in.)
PMSFO410R	3.8 x 19	CVD	5 1/2

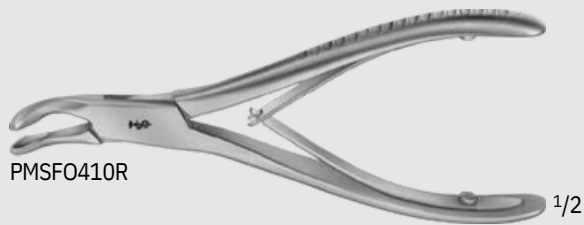

Orthopedics/Spine

Rongeurs

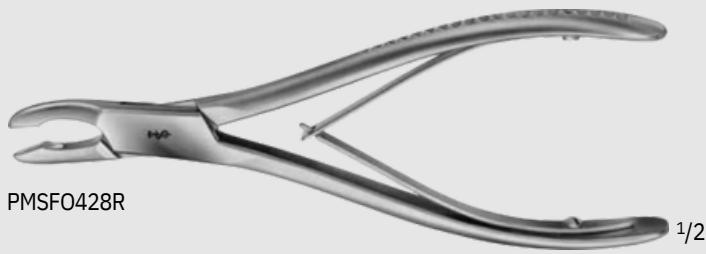

PMSFO428R



PMSFO428R

HAKANSSON Bone Rongeur

Catalog Number	Jaw Size (mm)	Jaw	Length (in.)
PMSFO428R	4.5 x 24	CVD	6 3/4

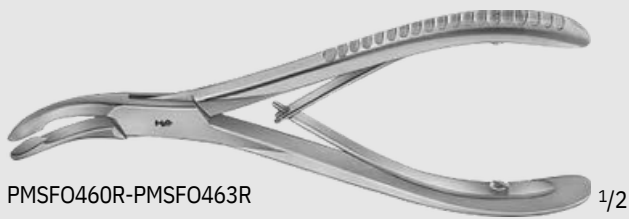

PMSFO460R-PMSFO463R



PMSFO460R



PMSFO462R



PMSFO411R



PMSFO412R

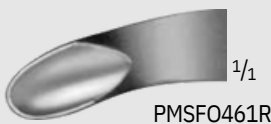

PMSFO461R

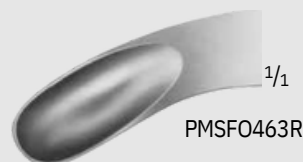

PMSFO463R

LUER Bone Rongeur

Catalog Number	Jaw Size (mm)	Jaw	Length (in.)
PMSFO460R	7.5 x 25	STR	6 7/8
PMSFO462R	9.5 x 33	STR	7
PMSFO411R	4.2 x 20	CVD	6
PMSFO412R	4.2 x 26	STRONG CVD	6 1/8
PMSFO461R	7.5 x 24.5	CVD	6 7/8
PMSFO463R	9.0 x 30	CVD	7

ORTHO
SPINE

MILLIMETERS

BLUMENTHAL Bone Rongeur

Catalog Number	Jaw Size (mm)	Jaw	Length (in.)
PMSFO415R	3.5 x 25	30° CVD	6 1/8
FPMSO416R	3.5 x 22	45° CVD	6



JANSEN Bone Rongeur

Catalog Number	Jaw Size (mm)	Jaw	Length (in.)
PMSFO430R	4.2 x 35	STR	6 7/8
PMSFO432R	4.5 x 30	CVD	6 7/8
PMSFO442R	3.8 x 37	ANG	7 1/2

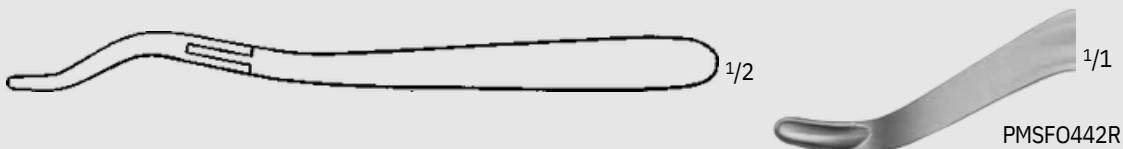
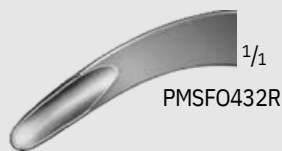

Orthopedics/Spine

Rongeurs



PMSFO440R

1/2



1/1

PMSFO440R

ALEXANDER Bone Rongeur

Catalog Number	Jaw Size (mm)	Jaw	Length (in.)
PMSFO440R	3.2 x 27	ANG	5 1/2

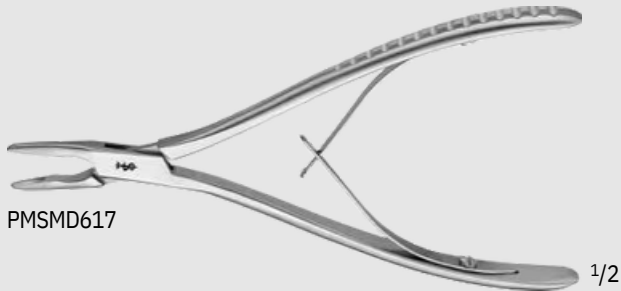

PMSMD617

1/2

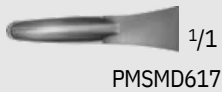

1/1

PMSMD617

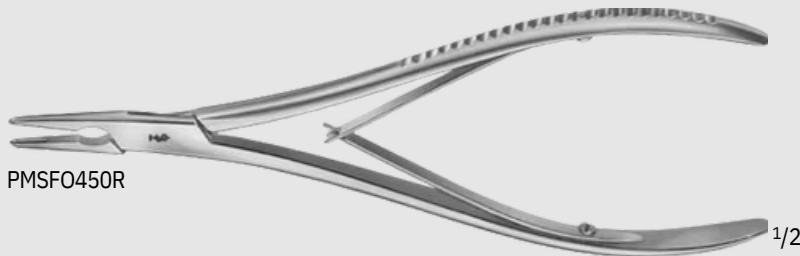

PMSFO450R

1/2



1/1

PMSFO450R

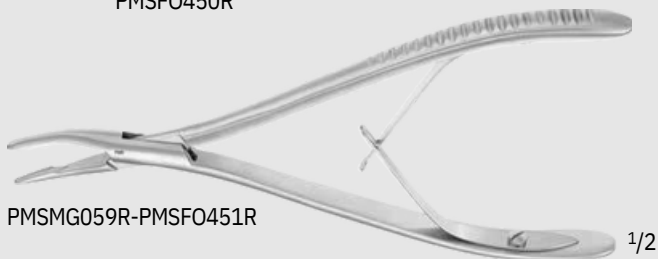

PMSMG059R-PMSFO451R

1/2



1/1

PMSMG059R



1/1

PMSFO451R

LEMPert Bone Rongeur

Catalog Number	Jaw Size (mm)	Jaw	Length (in.)
PMSMD617	2.0 x 23	DEL, STR	6 1/2
PMSFO450R	2.2 x 27	STR	7 7/8
PMSMG059R	2.5 x 30	CVD	6 1/4
PMSFO451R	2.2 x 27	CVD	7 7/8

ORTHO
SPINE

MILLIMETERS

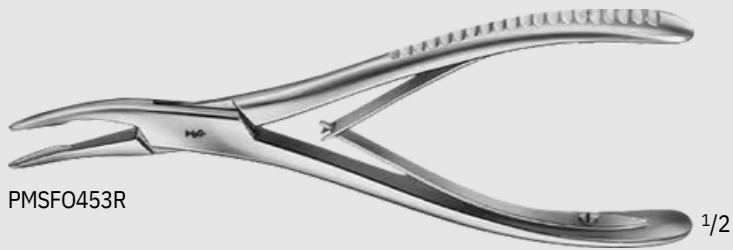

PMSFO453R

1/2



1/1

PMSFO453R

BEYER Bone Rongeur

Catalog Number	Jaw Size (mm)	Jaw	Length (in.)
PMSFO453R	3.2 x 32	CVD	7



PMSFO455R

1/2

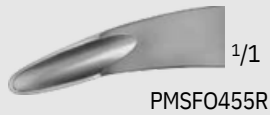

1/1

PMSFO455R

MEAD Bone Rongeur

Catalog Number	Jaw Size (mm)	Jaw	Length (in.)
PMSFO455R	3.5 x 30	CVD	6 1/2

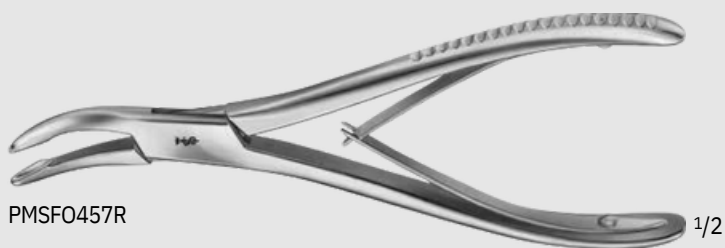

PMSFO457R

1/2



1/1

PMSFO457R

BANE-HARTMANN Bone Rongeur

Catalog Number	Jaw Size (mm)	Jaw	Length (in.)
PMSFO457R	4.0 x 32	CVD	6 7/8



ORTHO SPINE

INCHES

Orthopedics/Spine

Rongeurs

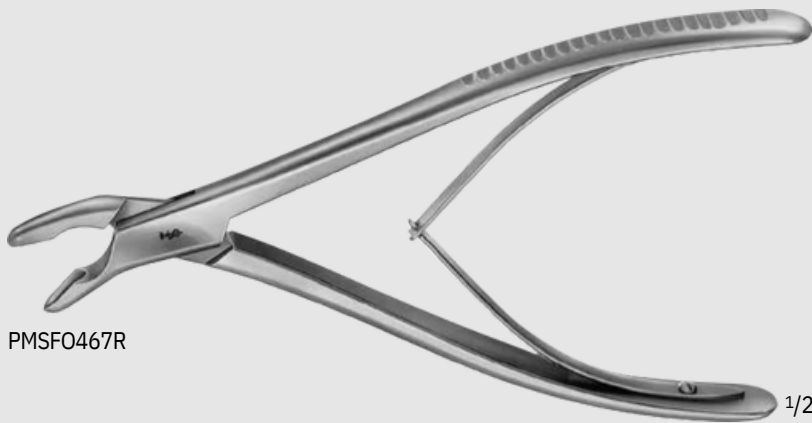

PMSFO467R

1/2

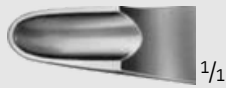

1/1

PMSFO467R

TROTTER Bone Rongeur

Catalog Number	Jaw Size (mm)	Jaw	Length (in.)
PMSFO467R	6.5 x 24	CVD	8



PMSFO470R

1/2



1/1

PMSFO470R

OLIVECRONA Bone Rongeur

Catalog Number	Jaw Size (mm)	Jaw	Length (in.)
PMSFO470R	5.0 x 36.5	CVD	8



PMSFO472R

1/2



1/1

PMSFO472R

GULEKE Bone Rongeur

Catalog Number	Jaw Size (mm)	Jaw	Length (in.)
PMSFO472R	6.5 x 27	CVD	8



ORTHO
SPINE

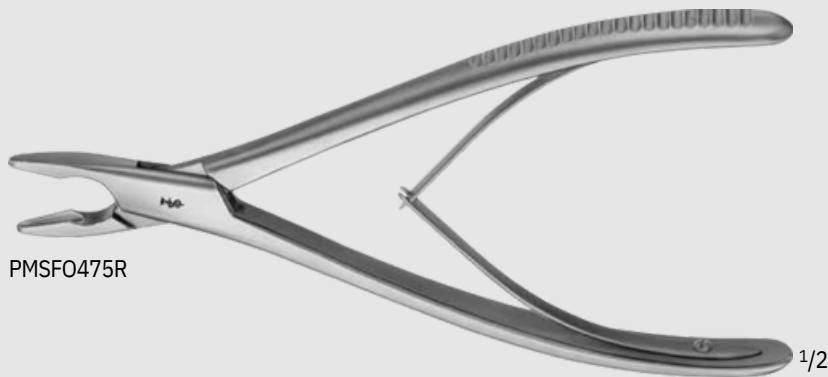

PMSFO475R

1/2



1/1

PMSFO475R

PENNYBACKER Bone Rongeur

Catalog Number	Jaw Size (mm)	Jaw	Length (in.)
PMSFO475R	4.0 x 26	STR	8

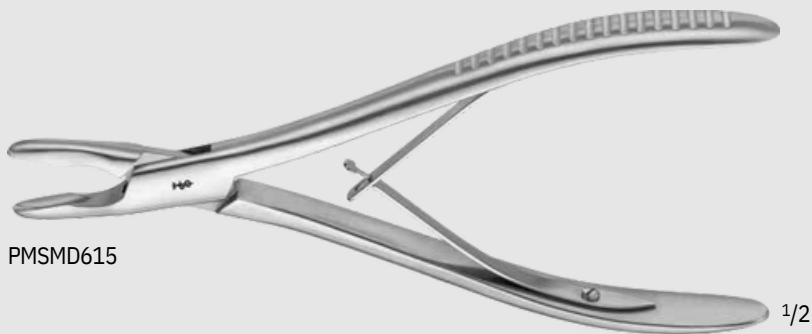

PMSMD615

1/2



1/1

PMSMD615

ADSON Cranial Rongeur

Catalog Number	Jaw Size (mm)	Jaw	Length (in.)
PMSMD615	21.0 x 31.5	STR	7 7/8



PMSMG060R

1/2

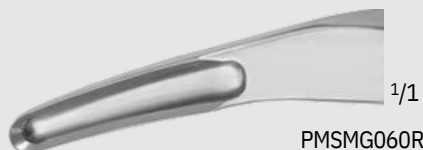

1/1

PMSMG060R

KLEINERT-KUTZ Rongeur, Double Action

Catalog Number	Jaw Size (mm)	Jaw	Length (in.)
MGPMS060R	3.0 x 15.0	SLIGHT, CVD	6 1/8



ORTHO
SPINE

INCHES

Orthopedics/Spine

Rongeurs



PMSFO500R-PMSFO502R



PMSFO500R



PMSFO502R

BOEHLER Bone Rongeur, Double Action

Catalog Number	Jaw Size (mm)	Jaw	Jaw End	Length (in.)
PMSFO500R	3.0 x 27.0	CVD	NARR	6 1/8
PMSFO502R	3.5 x 30.0	CVD	WIDE	6 1/8



PMSFO514R



PMSFO514R

BEYER Bone Rongeur, Double Action

Catalog Number	Jaw Size (mm)	Jaw	Length (in.)
PMSFO514R	4.0 x 30.0	CVD	7



PMSFO511R



PMSFO511R

MAYFIELD Bone Rongeur, Double Action

Catalog Number	Jaw Size (mm)	Jaw	Length (in.)
PMSFO511R	3.5 x 23	CVD	6 7/8

ORTHO
SPINE

MILLIMETERS



PMSFO515R

1/2



1/1

PMSFO515R

ZAUFAL-JANSEN Bone Rongeur, Double Action

Catalog Number	Jaw Size (mm)	Jaw	Length (in.)
PMSFO515R	4.5 x 29.0	CVD	7



PMSMG056R-PMSMG058R

1/2

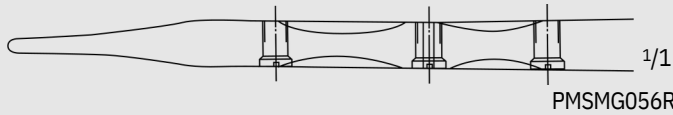

1/1

PMSMG056R

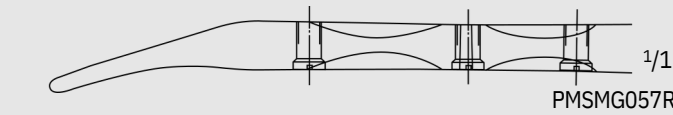

1/1

PMSMG057R

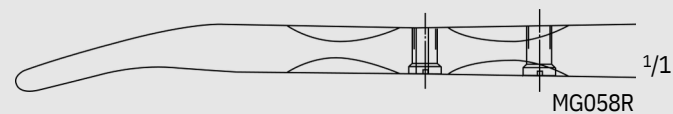

1/1

MG058R



PMSMG579R, PMSFO518R

1/2



1/1

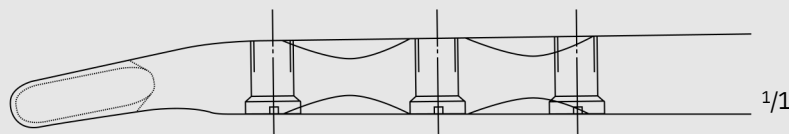

1/1

PMSMG579R, PMSFO518R

RUSKIN Bone Rongeur, Double Action

Catalog Number	Jaw Size (mm)	Jaw	Length (in.)
PMSMG056R	2	STR, MINI	6 1/4
PMSMG057R	2	CVD, MINI	6 1/4
PMSMG058R	3	CVD, MINI	6 1/4
PMSFO518R	5	CVD	7 1/2
PMSMG579R	6	CVD	7 1/4



ORTHO SPINE

INCHES

Orthopedics/Spine

Rongeurs

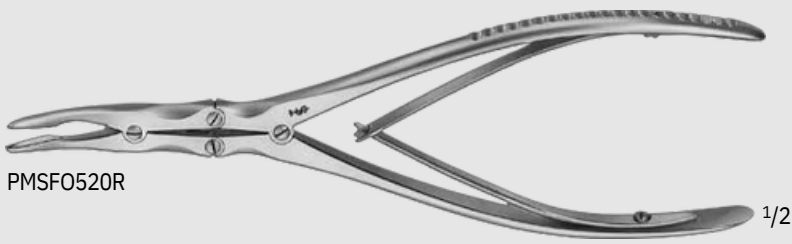

PMSFO520R

1/2



1/1

PMSFO520R

MARQUARDT Bone Rongeur, Double Action

Catalog Number	Jaw Size (mm)	Jaw	Length (in.)
PMSFO520R	3.5 x 15.5	CVD	7 7/8

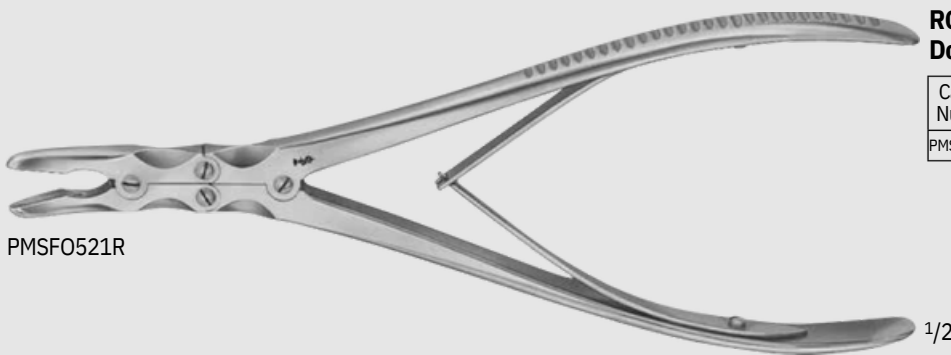

PMSFO521R

ROETTGEN-RUSKIN Bone Rongeur, Double Action

Catalog Number	Jaw Size (mm)	Jaw	Length (in.)
PMSFO521R	6.3 x 30	CVD	9 1/2

1/2



1/1

PMSFO521R



PMSMG577R

SMITH-PETERSON Rongeur

Catalog Number	Jaw Size (mm)	Jaw	Length (in.)
PMSMG577R	3	STR	9 1/2

1/2



1/1

PMSMG577R





PMSFO522R-PMSFO523R

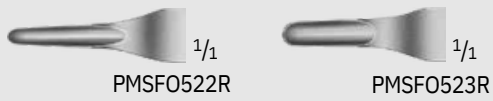

ECHLIN Bone Rongeur, Double Action, Duckbill

Catalog Number	Jaw Size (mm)	Jaw	Length (in.)
PMSFO522R	2 x 10	ANG	9
PMSFO523R	3 x 10	ANG	9

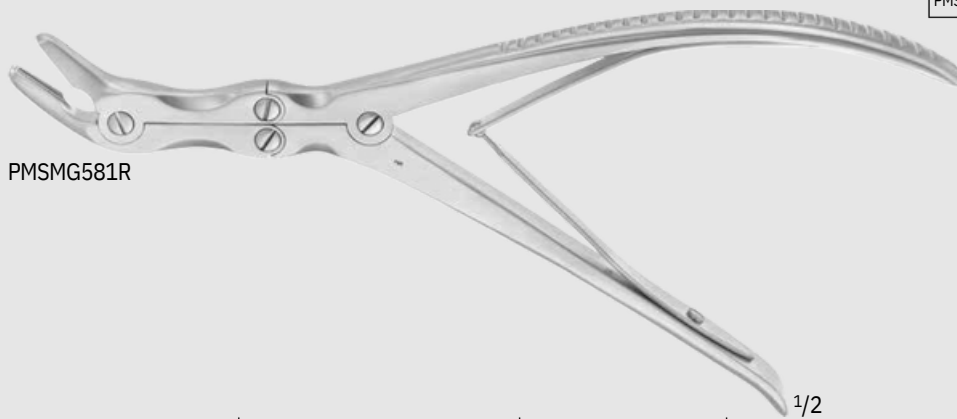

PMSMG581R

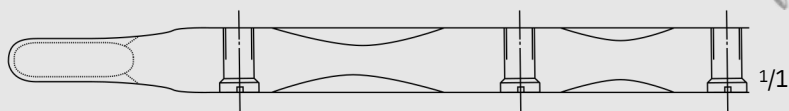

PMSMG581R

LEKSELL Bone Rongeur, Double Action, Duckbill

Catalog Number	Jaw Size (mm)	Jaw	Length (in.)
PMSMG581R	5	FULL CVD	9
PMSFO526R	5 x 16	ANG	9 5/8
PMSFO527R	3 x 16	ANG	9 5/8



PMSFO526R-PMSFO527R

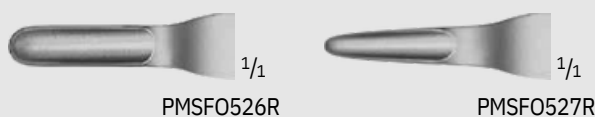

Orthopedics/Spine

Rongeurs



FRYKHOLM Bone Rongeur, Double Action

Catalog Number	Jaw Size (mm)	Jaw	Length (in.)
PMSFO525R	4.5 x 25	ANG	9 1/2

PMSFO525R



PMSFO525R

1/2

1/1

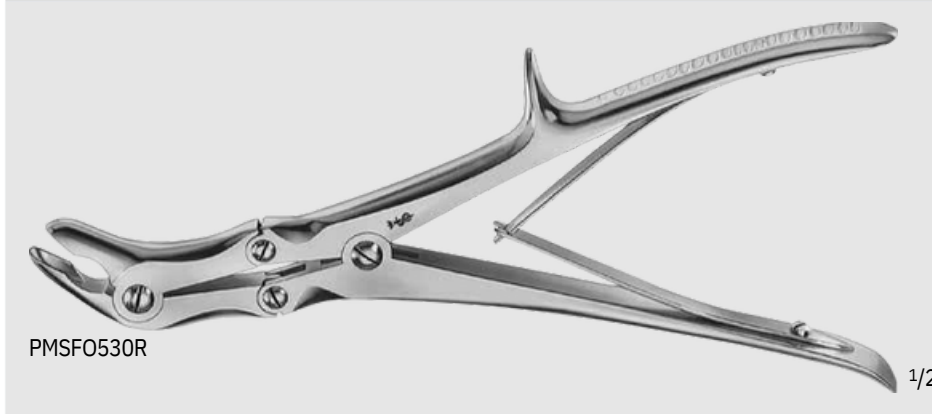

STILLE Bone Rongeur, Double Action, Duckbill

Catalog Number	Jaw Size (mm)	Jaw	Length (in.)
PMSFO530R	7.0 x 25	ANG	9

PMSFO530R

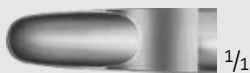

PMSFO530R

1/2

1/1

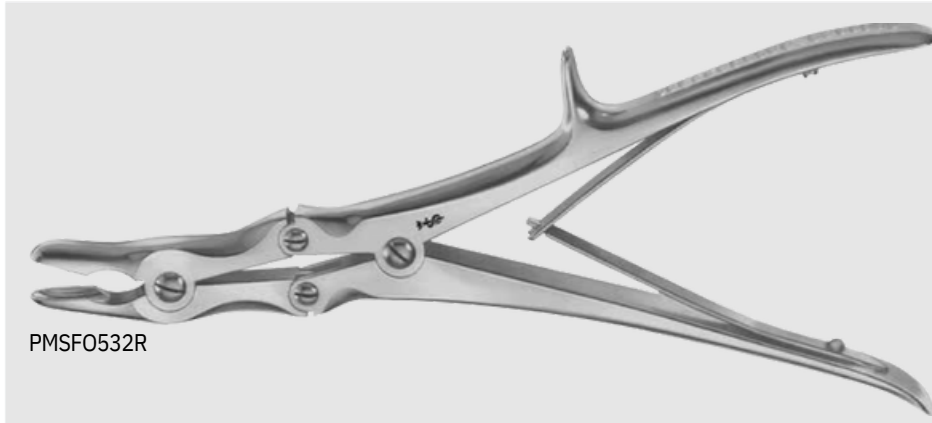

LEKSELL-STILLE Bone Rongeur, Double Action, Duckbill

Catalog Number	Jaw Size (mm)	Jaw	Length (in.)
PMSFO532R	7.5 x 29.5	ANG	9 1/2

PMSFO532R



PMSFO532R

1/2

1/1

SYPERT Bone Rongeur, Double Action

Catalog Number	Jaw Size (mm)	Jaw	Length (in.)
PMSFG052R	8.0 x 35.0	ANG	14 1/4

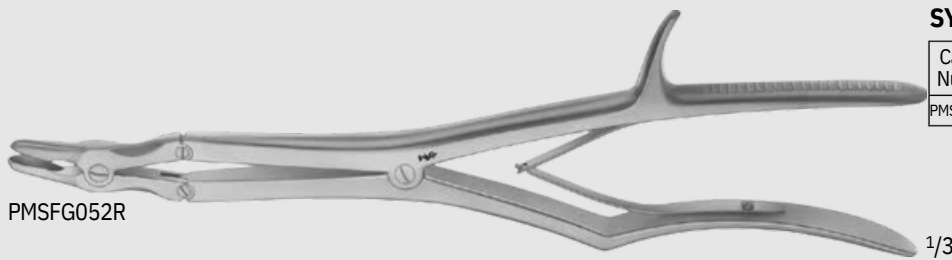

STILLE-RUSKIN Bone Rongeur, Double Action

Catalog Number	Jaw Size (mm)	Jaw	Length (in.)
PMSFO534R	8.0 x 34.0	CVD	9 1/2

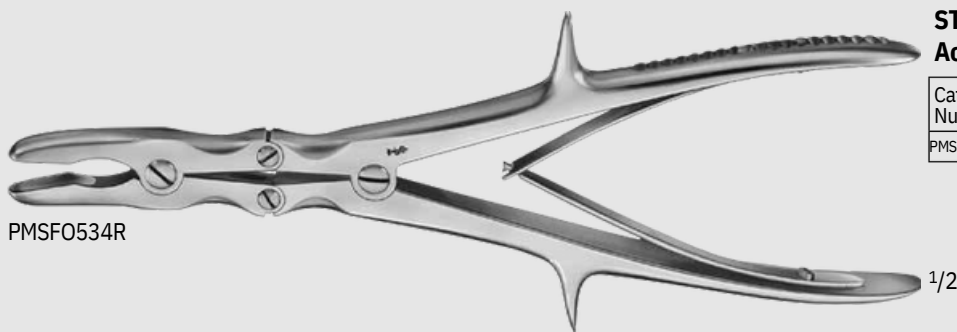

SAUERBRUCH-CORYLLOS Rongeur, Double Action

Catalog Number	Length (in.)
PMSFO570R	12 1/4
PMSFO572R	12 1/4

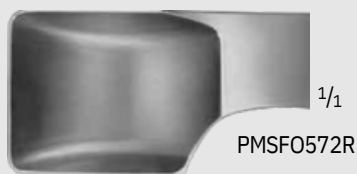
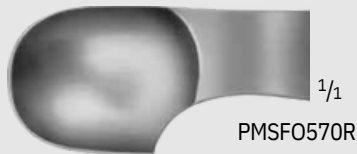

Orthopedics/Spine

Rongeurs

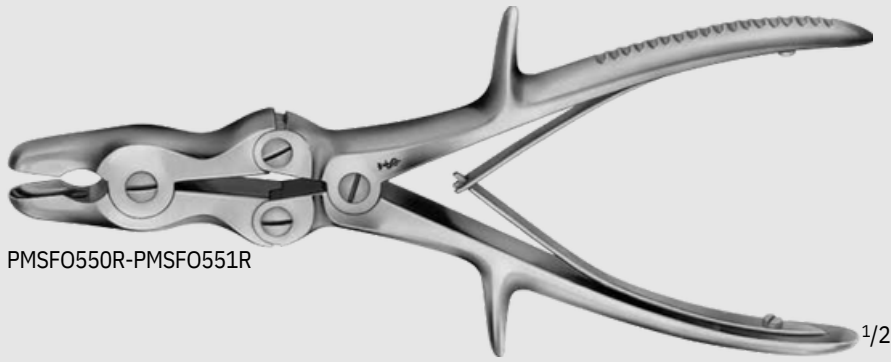

PMSFO550R-PMSFO551R

LUER-STILLE Bone Rongeur, Double Action

Catalog Number	Jaw Size (mm)	Jaw	Length (in.)
PMSFO550R	10.5 x 27.5	STR	8 7/8
PMSFO551R	10 x 26.5	CVD	8 7/8



PMSFO550R

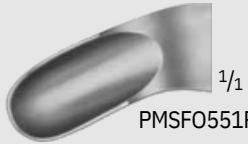

PMSFO551R

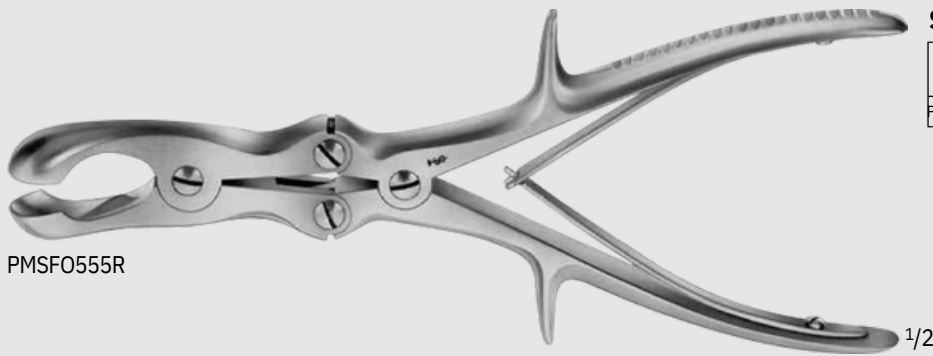

PMSFO555R

SEMB Bone Rongeur, Double Action

Catalog Number	Jaw Size (mm)	Jaw	Length (in.)
PMSFO555R	16.5 x 38.5	CVD	9 1/2



1/1



1/1

PMSFO555R

ORTHO
SPINE

MILLIMETERS

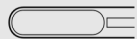
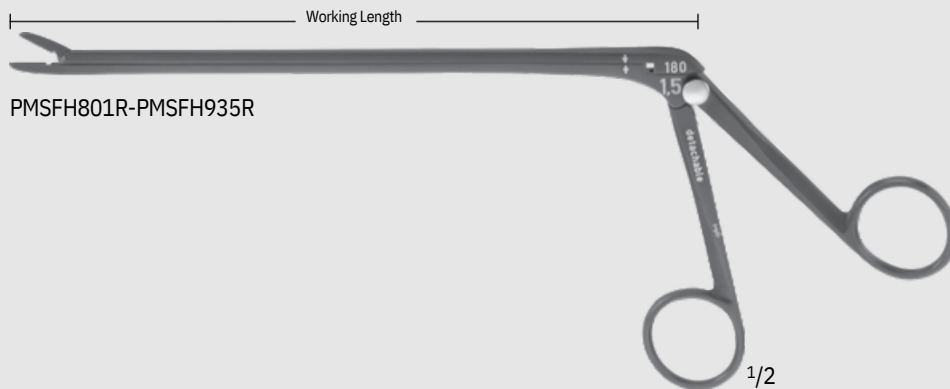

Noir Detachable Rongeurs

Working Length (in.)	Jaw	Jaw	1.5 mm	2.0 mm	3.0 mm	4.0 mm	5.0 mm
6		STR	PMSFH801B	PMSFH802B	PMSFH803B	PMSFH804B	PMSFH805B
6		UP	PMSFH901B	PMSFH902B	PMSFH903B	PMSFH904B	PMSFH905B
7		STR	PMSFH811B	PMSFH812B	PMSFH813B	PMSFH814B	PMSFH815B
7		UP	PMSFH911B	PMSFH912B	PMSFH913B	PMSFH914B	PMSFH915B
7 7/8		STR	PMSFH821B	PMSFH822B	PMSFH823B	PMSFH824B	PMSFH825B
7 7/8		UP	PMSFH921B	PMSFH922B	PMSFH923B	PMSFH924B	PMSFH925B
9		STR	PMSFH891B	PMSFH892B	PMSFH893B	PMSFH894B	PMSFH895B
9		UP	PMSFH931B	PMSFH932B	PMSFH933B	PMSFH934B	PMSFH935B
11		STR	-	-	PMSFH837B	PMSFH838B	PMSFH839B



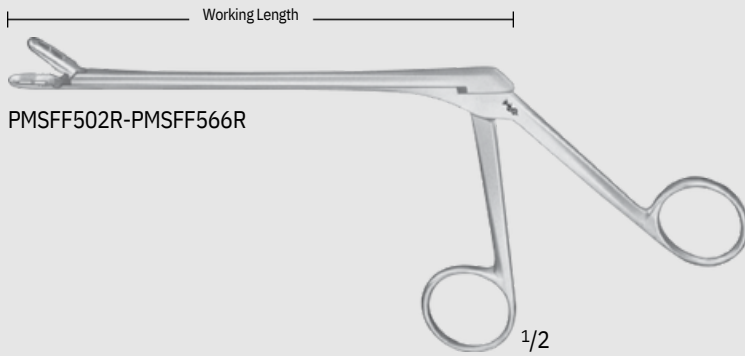

PMSFF502R-PMSFF566R



PMSFF502R, PMSFF532R, PMSFF562R



PMSFF503R, PMSFF533R, PMSFF563R



PMSFF504R, PMSFF534R, PMSFF564R



PMSFF535R, PMSFF565R



PMSFF536R, PMSFF566R

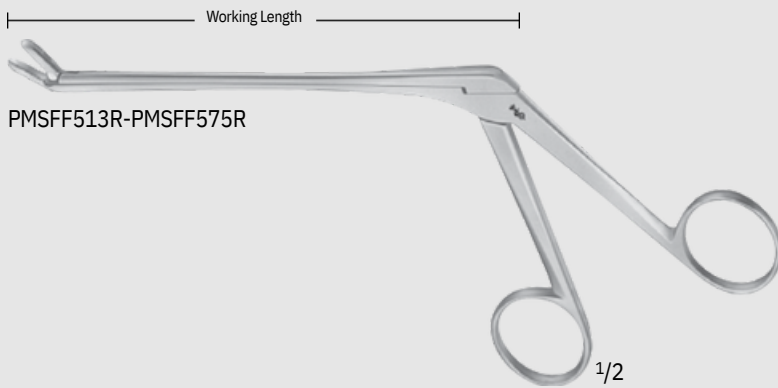

PMSFF513R-PMSFF575R



PMSFF513R, PMSFF543R, PMSFF573R



PMSFF514R, PMSFF544R, PMSFF574R



PMSFF545R, PMSFF575R

CASPAR Rongeur W/ Teeth

Catalog Number	Jaw Size (mm)	Jaw	Working Length (in.)
PMSFF502R	2 x 12	STR	5 1/2
PMSFF532R	2 x 12	STR	6 1/4
PMSFF562R	2 x 12	STR	7 1/4
PMSFF503R	3 x 12	STR	5 1/2
PMSFF533R	3 x 12	STR	6 1/4
PMSFF563R	3 x 12	STR	7 1/4
PMSFF504R	4 x 14	STR	5 1/2
PMSFF534R	4 x 14	STR	6 1/4
PMSFF564R	4 x 14	STR	7 1/4
PMSFF535R	5 x 14	STR	6 1/4
PMSFF565R	5 x 14	STR	7 1/4
PMSFF536R	6 x 16	STR	6 1/4
PMSFF566R	6 x 16	STR	7 1/4
PMSFF513R	3 x 12	UP	5 1/2
PMSFF543R	3 x 12	UP	6 1/4
PMSFF573R	3 x 12	UP	7 1/4
PMSFF514R	4 x 14	UP	5 1/2
PMSFF544R	4 x 14	UP	6 1/4
PMSFF574R	4 x 14	UP	7 1/4
PMSFF545R	5 x 14	UP	6 1/4
PMSFF575R	5 x 14	UP	7 1/4





ORTHO SPINE

INCHES

Orthopedics/Spine

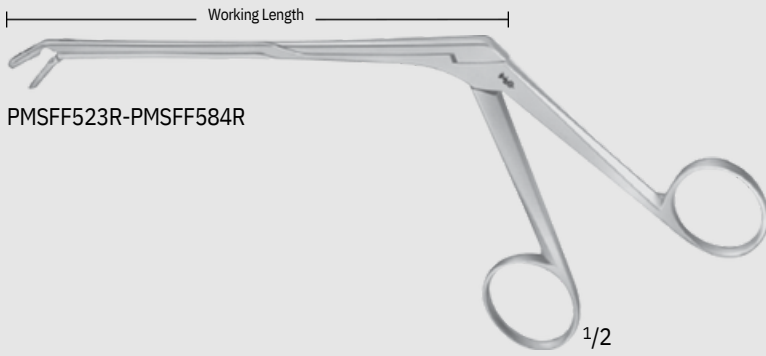
Rongeurs

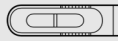

 1/1
 PMSFF523R, PMSFF553R, PMSFF583R

 1/1
 PMSFF524R, PMSFF554R, PMSFF584R

CASPAR Rongeur W/ Teeth (continued)

Catalog Number	Jaw Size (mm)	Jaw	Working Length (in.)
PMSFF523R	3 x 12	DOWN	5 1/2
PMSFF553R	3 x 12	DOWN	6 1/4
PMSFF583R	3 x 12	DOWN	7 1/4
PMSFF524R	4 x 14	DOWN	5 1/2
PMSFF554R	4 x 14	DOWN	6 1/4
PMSFF584R	4 x 14	DOWN	7 1/4

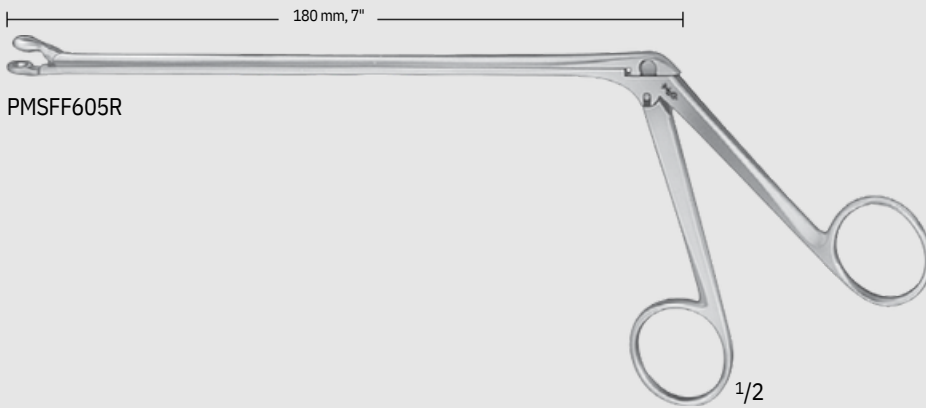

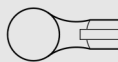
 1/1
 PMSFF605R

OLDBERG Rongeur

Catalog Number	Diameter (mm)	Working Length (in.)
PMSFF605R	7.0	7

195 mm, 7 1/2"

PMSFF599R-PMSFF600R

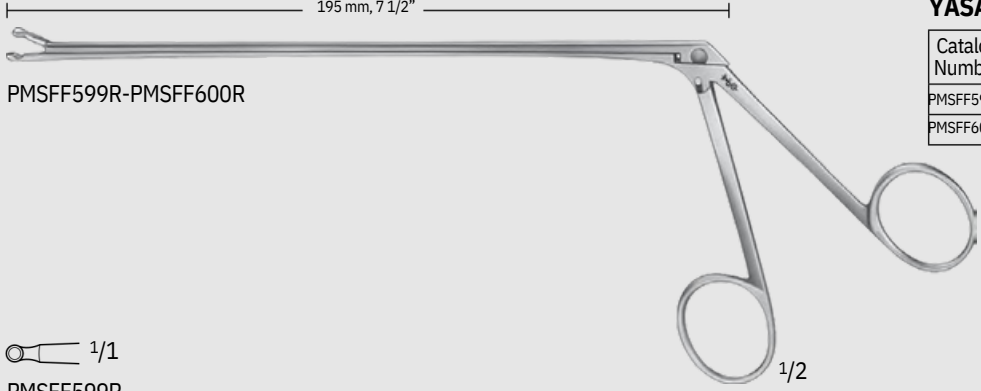

1/1
PMSFF599R

1/1
PMSFF600R

1/2

YASARGIL Rongeur

Catalog Number	Diameter (mm)	Working Length (in.)
PMSFF599R	2.2	7 1/2
PMSFF600R	3.5	7 1/2

140 mm, 5 1/2"

PMSFF765R

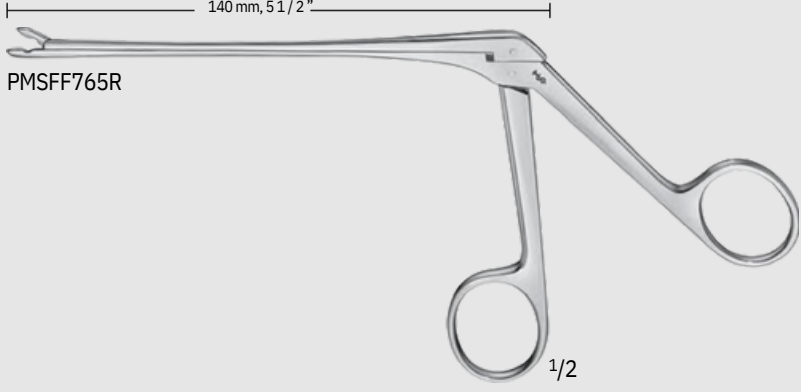

1/1
PMSFF765R

1/2

BECK Rongeur

Catalog Number	Jaw Size (mm)	Working Length (in.)
PMSFF765R	2 x 10	5 1/8

210 mm, 8 1/4"

PMSFF808R

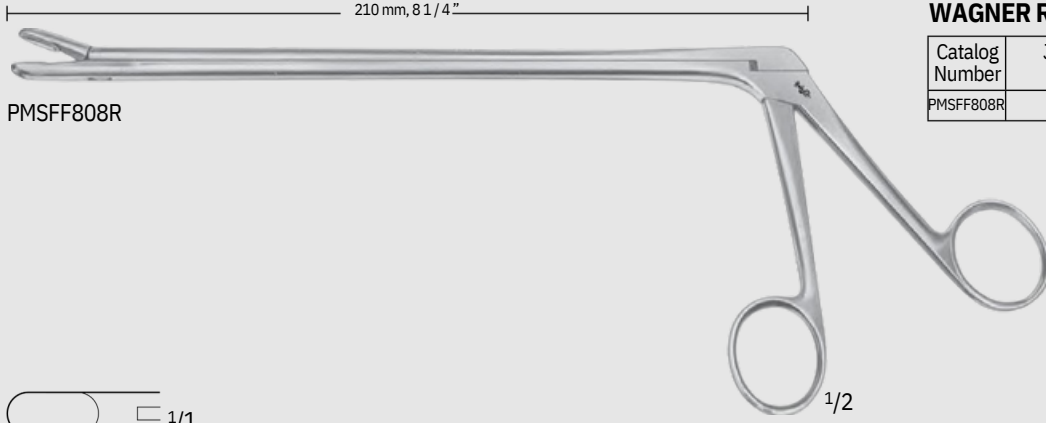

1/1
PMSFF808R

1/2

WAGNER Rongeur

Catalog Number	Jaw Size (mm)	Working Length (in.)
PMSFF808R	5.5	8 1/4



ORTHO
SPINE

INCHES

Orthopedics/Spine

Rongeurs

1.5 x 10

1.5 x 10

CUSHING Rongeur

Catalog Number	Jaw Size (mm)	Jaw	Style	Working Length (in.)
PMSMD537R	1.5 x 10	STR	STANDARD	7
PMSMN090R	1.5 x 10	STR	DELICATE	9
PMSFF803R	2 x 10	STR	-	7
PMSMN093R	2 x 10	STR	STANDARD	9
PMSMN096R	2 x 10	STR	STANDARD	11
PMSMN099R	2 x 10	STR	STANDARD	12
PMSMD538R	1.5 x 10	UP	STANDARD	7
PMSMD618	2 x 10	UP	-	7
PMSMN091R	1.5 x 10	UP	DELICATE	9
PMSMN094R	2 x 10	UP	STANDARD	9
PMSMN097R	2 x 10	UP	STANDARD	11
PMSMN100R	2 x 10	UP	STANDARD	12
PMSMD539R	1.5 x 10	DOWN	STANDARD	7
PMSMN092R	1.5 x 10	DOWN	DELICATE	9
PMSMD619	2 x 10	DOWN	-	7
PMSMN095R	2 x 10	DOWN	STANDARD	9
PMSMN098R	2 x 10	DOWN	STANDARD	11
PMSMN101R	2 x 10	DOWN	STANDARD	12

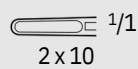
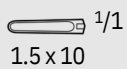
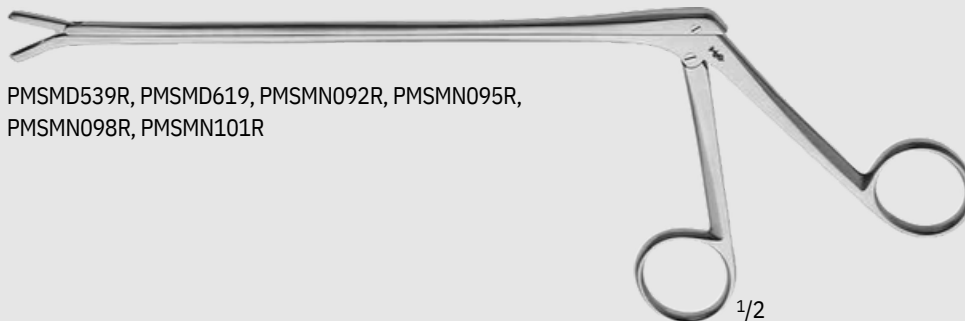
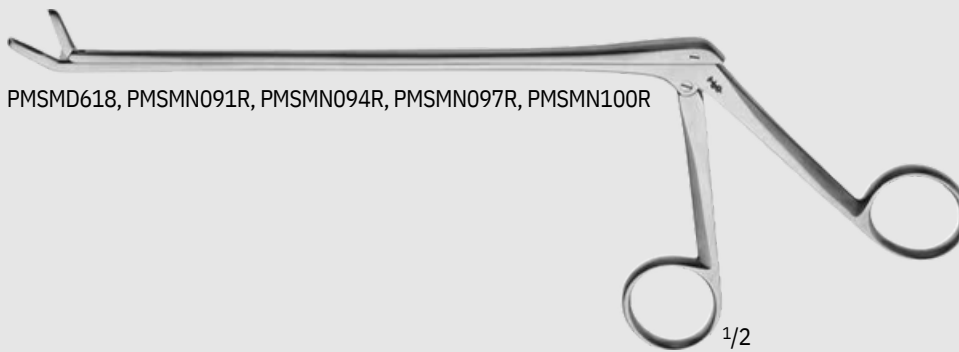

LOVE-GRUENWALD Rongeur

Catalog Number	Jaw Size (mm)	Jaw	Working Length (in.)
PMSFF805R	3 x 10	STR	7
PMSMN102R	3 x 10	STR	9
PMSMN105R	3 x 10	STR	11
PMSMN108R	3 x 10	STR	12
PMSMF446R	2 x 10	UP	5
PMSFF806R	3 x 10	UP	7
PMSMN103R	3 x 10	UP	9
PMSMN106R	3 x 10	UP	11
PMSMN109R	3 x 10	UP	12
PMSMF447R	2 x 10	DOWN	5
PMSFF810R	3 x 10	DOWN	7
PMSMN104R	3 x 10	DOWN	9
PMSMN107R	3 x 10	DOWN	11
PMSMN110R	3 x 10	DOWN	12

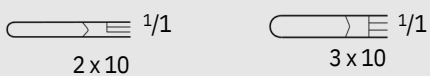
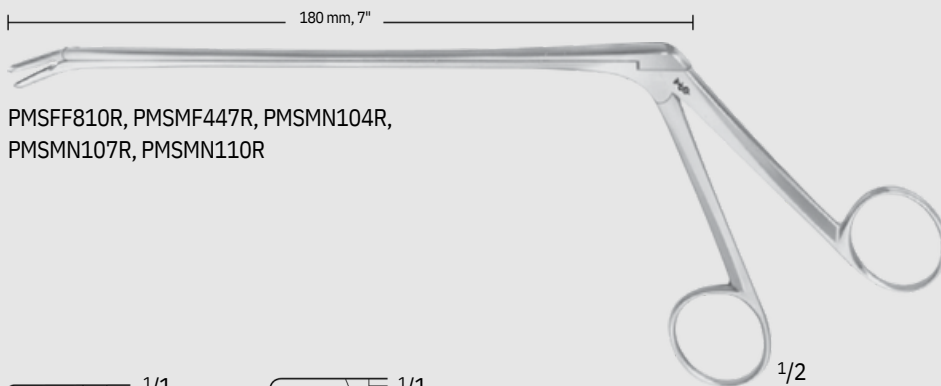
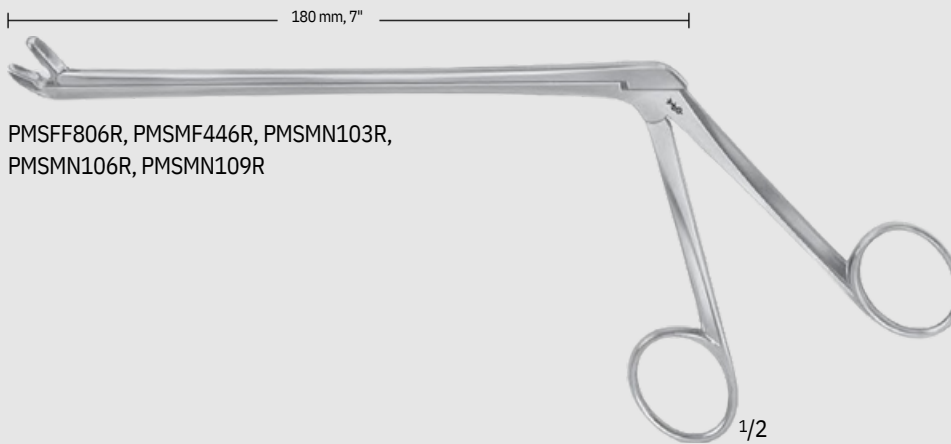
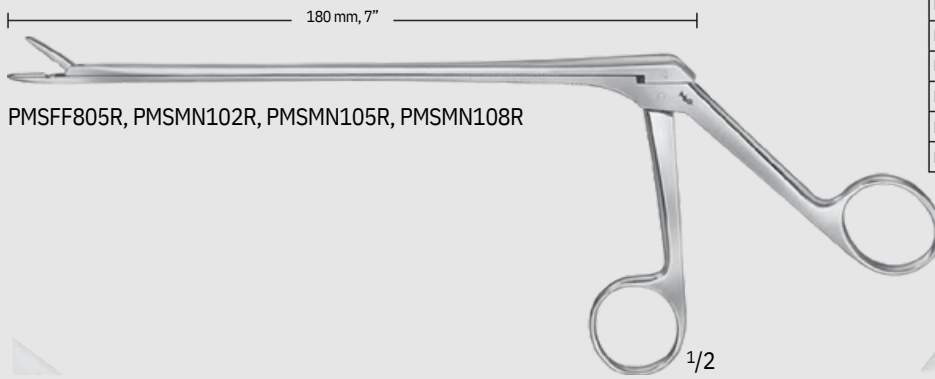

Orthopedics/Spine

Rongeurs

SPURLING Rongeur

Catalog Number	Jaw Size (mm)	Jaw	Working Length (in.)
PMSFF807R	4 x 10	STR	7
PMSMN111R	4 x 10	STR	9
PMSMN114R	4 x 10	STR	11
PMSMN117R	4 x 10	STR	12
PMSFF814R	4 x 10	UP	7
PMSMN112R	4 x 10	UP	9
PMSMN115R	4 x 10	UP	11
PMSMN118R	4 x 10	UP	12
PMSFF811R	4 x 10	DOWN	7
PMSMN113R	4 x 10	DOWN	9
PMSMN116R	4 x 10	DOWN	11
PMSMN119R	4 x 10	DOWN	12

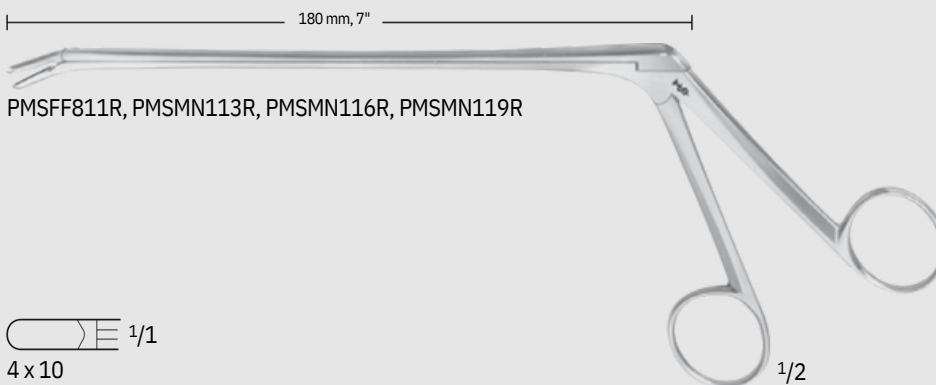
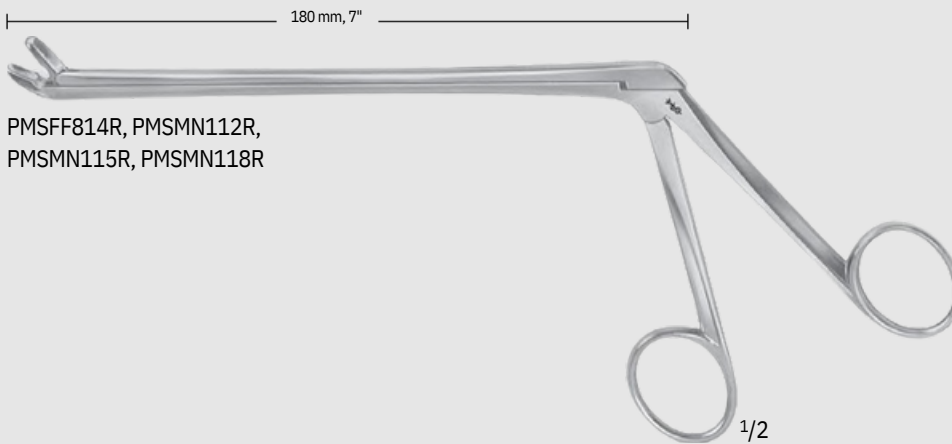
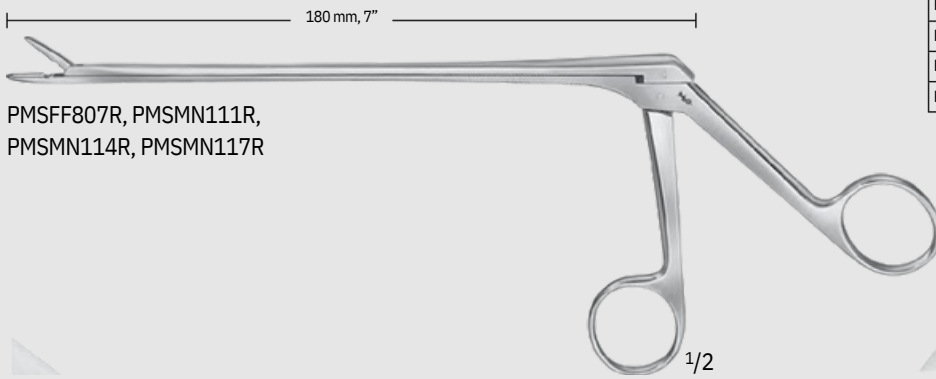

ORTHO
SPINE

MILLIMETERS

IVD Rongeur

Catalog Number	Jaw Size (mm)	Jaw	Working Length (in.)
PMSMN120R	5 x 10	STR	9
MPMSN123R	5 x 10	STR	11
PMSMN126R	5 x 10	STR	12
PMSMN121R	5 x 10	UP	9
PMSMN124R	5 x 10	UP	11
PMSMN127R	5 x 10	UP	12
PMSMN122R	5 x 10	DOWN	9
PMSMN125R	5 x 10	DOWN	11
PMSMN128R	5 x 10	DOWN	12

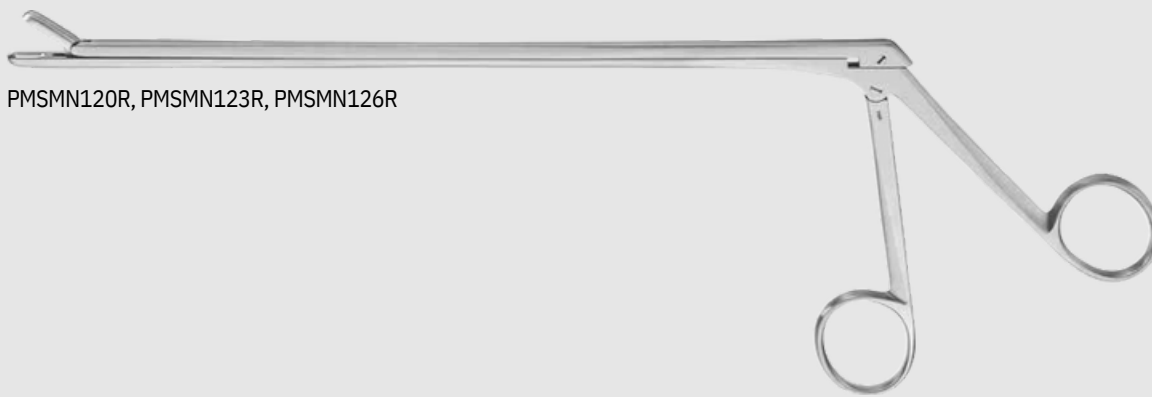

PMSMN120R, PMSMN123R, PMSMN126R



PMSMN121R, PMSMN124R, PMSMN127R

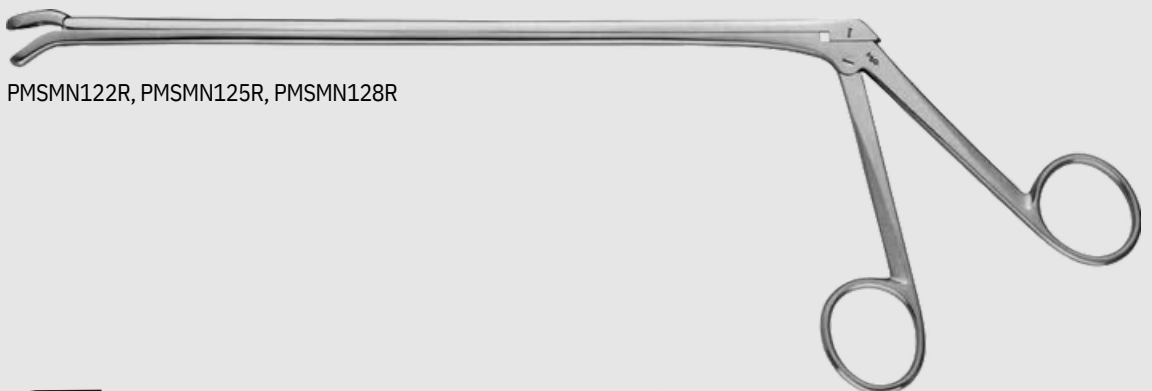

PMSMN122R, PMSMN125R, PMSMN128R

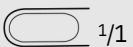

PMSMN120R,
PMSMN123R,
PMSMN126R



PMSMN121R,
PMSMN124R,
PMSMN127R

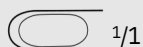

PMSMN122R,
PMSMN125R,
PMSMN128R



Orthopedics/Spine

Rongeurs

WAGNER Rongeur

Catalog Number	Jaw Size (mm)	Working Length (in.)
PMSFF818R	5.5	7 7/8

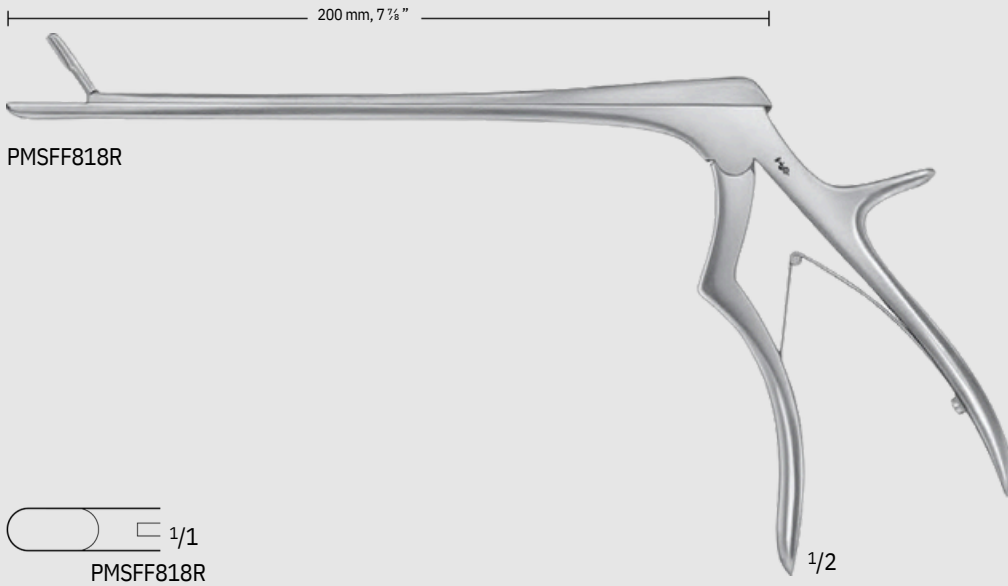

ORTHO
SPINE

MILLIMETERS

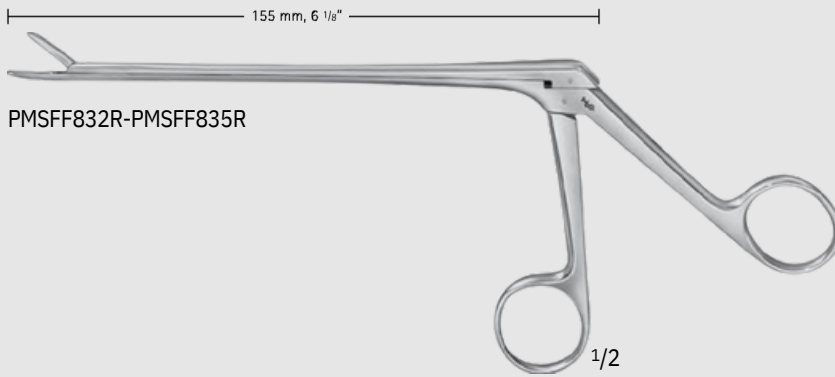

PMSFF832R-PMSFF835R

CASPAR Rongeur

Catalog Number	Jaw Size (mm)	Jaw	Working Length (in.)
PMSFF832R	2.0	STR	6 1/8
PMSFF833R	3.0	STR	6 1/8
PMSFF834R	4.0	STR	6 1/8
PMSFF835R	5.0	STR	6 1/8
PMSFF842R	2.0	UP	6 1/8
PMSFF843R	3.0	UP	6 1/8
PMSFF844R	4.0	UP	6 1/8
PMSFF852R	2.0	DOWN	6 1/8
PMSFF853R	3.0	DOWN	6 1/8
PMSFF854R	4.0	DOWN	6 1/8



PMSFF832R,
PMSFF842R,
PMSFF852R

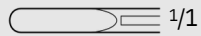

PMSFF833R,
PMSFF843R,
PMSFF853R

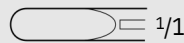

PMSFF834R,
PMSFF844R,
PMSFF854R

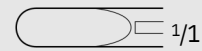

PMSFF835R

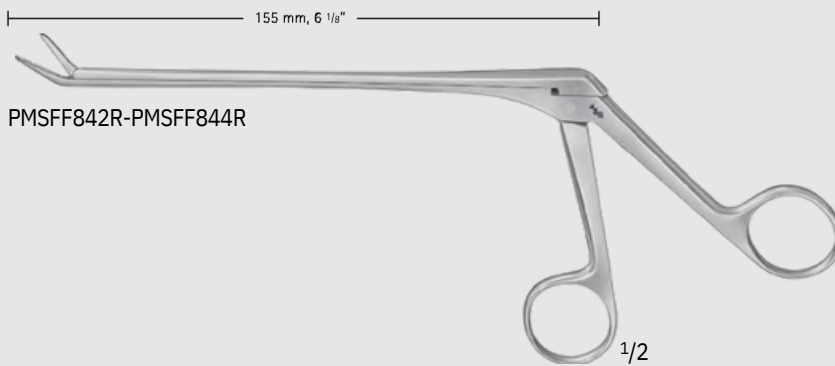

PMSFF842R-PMSFF844R



PMSFF852R-PMSFF854R



Orthopedics/Spine

Rongeurs

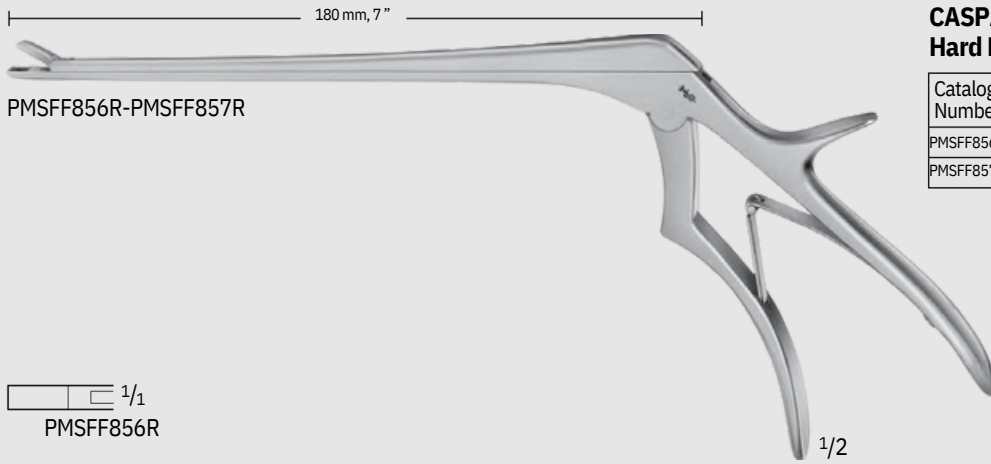

PMSFF856R-PMSFF857R

CASPAR Heavy Rongeur, F/ Removal of Hard Disc Pathology

Catalog Number	Jaw Size (mm)	Jaw	Working Length (in.)
PMSFF856R	3.0	STR	7
PMSFF857R	4.0	STR	7



PMSFF856R



PMSFF857R

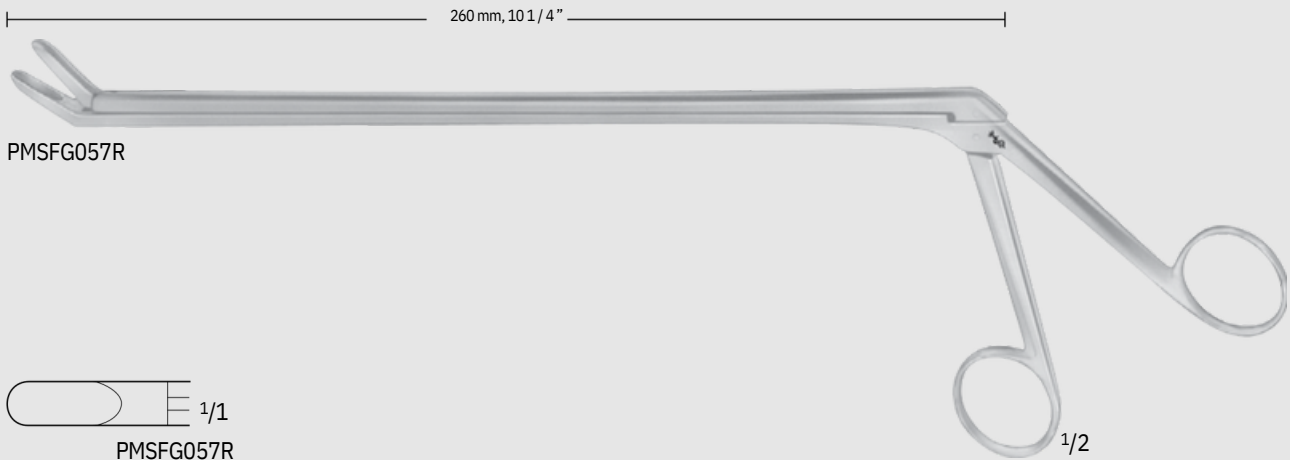

PMSFG057R

SYPERT Rongeur

Catalog Number	Jaw Size (mm)	Jaw	Working Length (in.)
PMSFG057R	5 x 20	UP	10 1/4

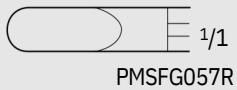

PMSFG057R

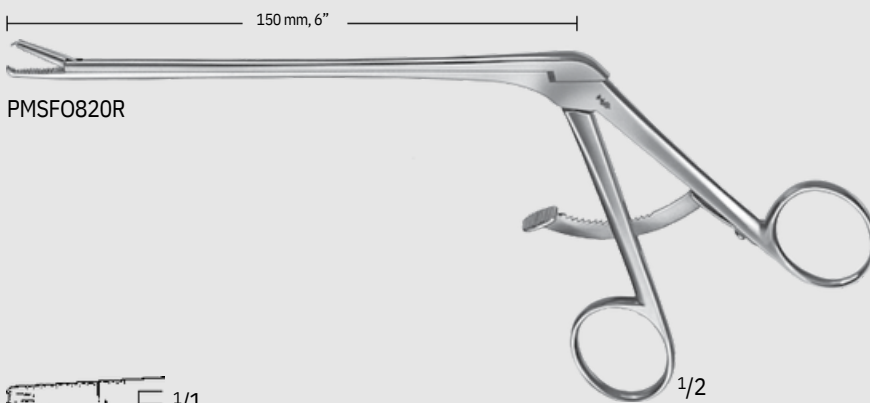

PMSFO820R

KRAEMER Grasping Forceps, W/ Catch

Catalog Number	Working Length (in.)
PMSFO820R	6



PMSFO820R



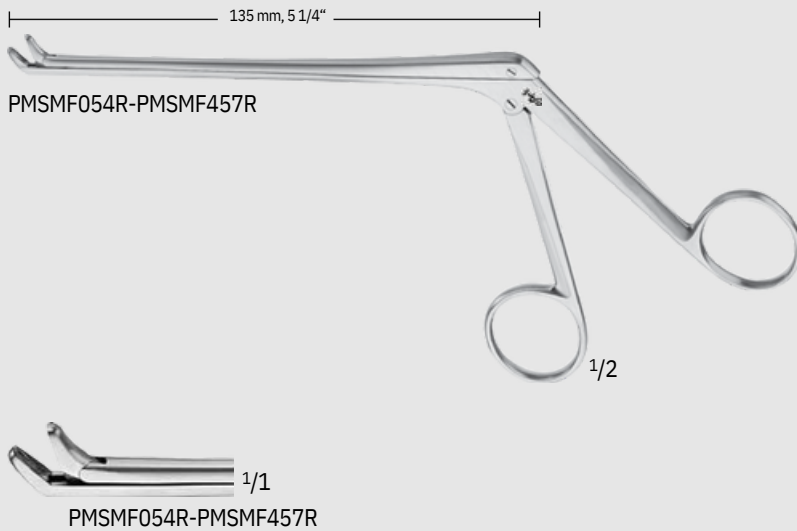

PEAPOD Disc Rongeur

Catalog Number	Jaw Size (mm)	Jaw	Working Length (in.)
PMSMF054R	2 x 6	UP	5 1/2
PMSMF456R	3 x 6	UP	5 1/4
PMSMF457R	4 x 6	UP	5 1/4

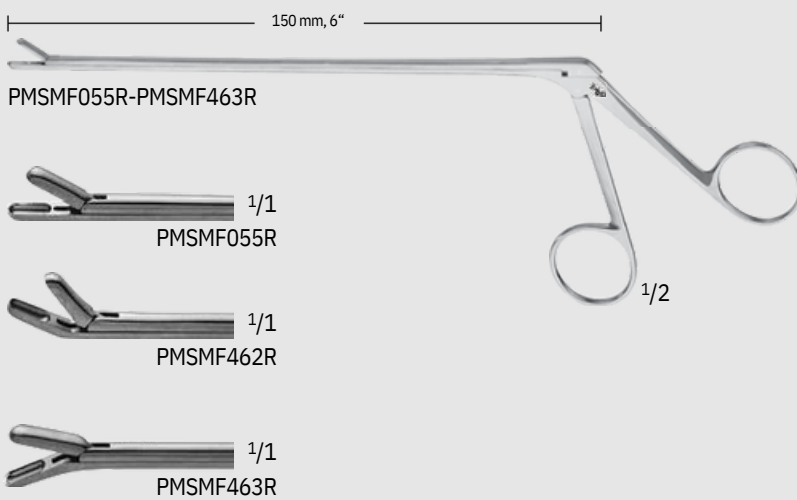

DECKER Rongeur

Catalog Number	Jaw Size (mm)	Jaw	Working Length (in.)
PMSMF055R	2 x 6	STR	6
PMSMF462R	2 x 6	UP	6
PMSMF463R	2 x 6	DOWN	6

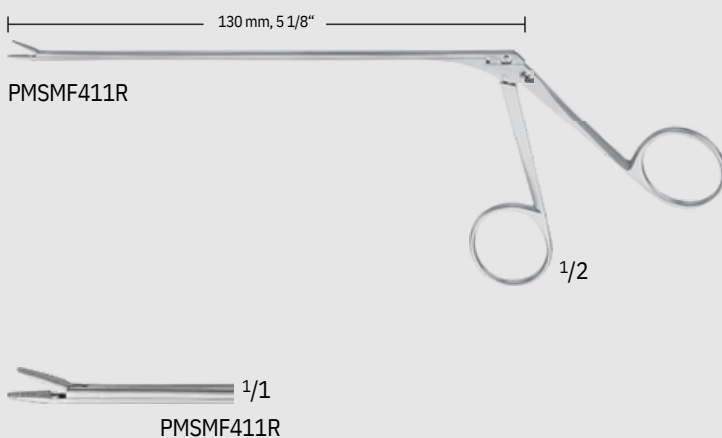

STEVENSON Grasping Forceps

Catalog Number	Jaw Size (mm)	Jaw	Working Length (in.)
PMSMF411R	6.0	STR	5 1/8

Orthopedics/Spine

Rongeurs

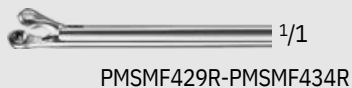

Rhoton Style Cup Forceps

Catalog Number	Jaw Size (mm)	Jaw	Working Length (in.)
PMSMF429R	0.5	STR	5 1/8
PMSMF432R	1.0	STR	5 1/8
PMSMF435R	2.0	STR	5 1/8
PMSMF436R	3.0	STR	5 1/8
PMSMF437R	4.0	STR	5 1/8
PMSMF438R	5.0	STR	5 1/8
PMSMF430R	0.5	RIGHT	5 1/8
PMSMF433R	1.0	RIGHT	5 1/8
PMSMF431R	0.5	LEFT	5 1/8
PMSMF434R	1.0	LEFT	5 1/8

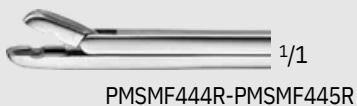
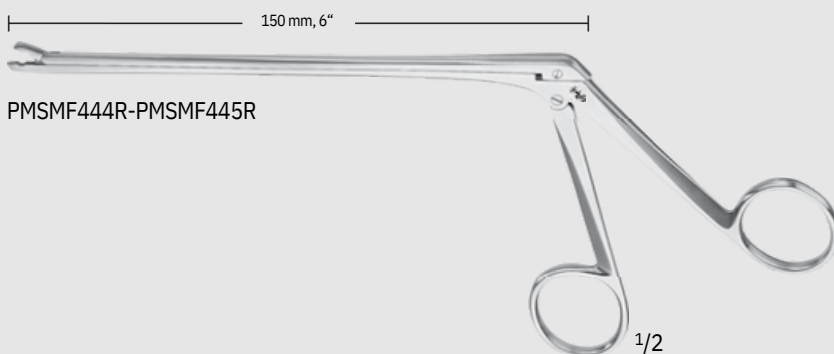

SELVERSTONE Rongeur

Catalog Number	Jaw Size (mm)	Jaw	Working Length (in.)
PMSMF444R	2 x 3	STR	6
PMSMF445R	2 x 5	STR	6

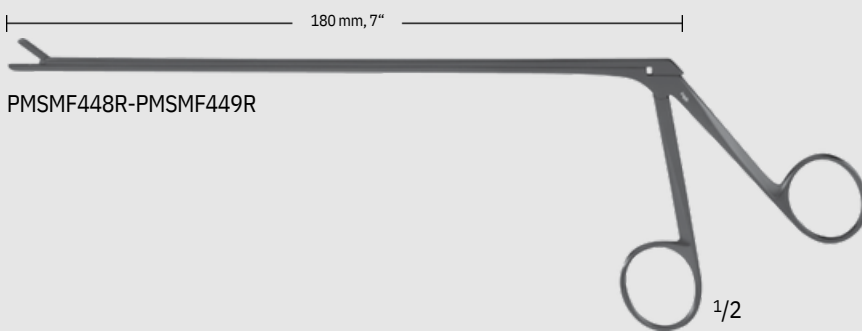

Black Coated Micro Pituitary Rongeur

Catalog Number	Jaw Size (mm)	Jaw	Working Length (in.)
PMSMF448R	2 x 6	STR	7
PMSMF449R	2 x 6	UP	7

ORTHO
SPINE

MILLIMETERS



PMSMF464R

WILLIAMS Discectomy Forceps

Catalog Number	Jaw Size (mm)	Jaw	Working Length (in.)
PMSMF464R	2 x 6	STR	5 1/4

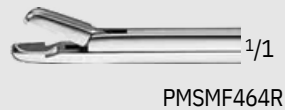

PMSMF464R

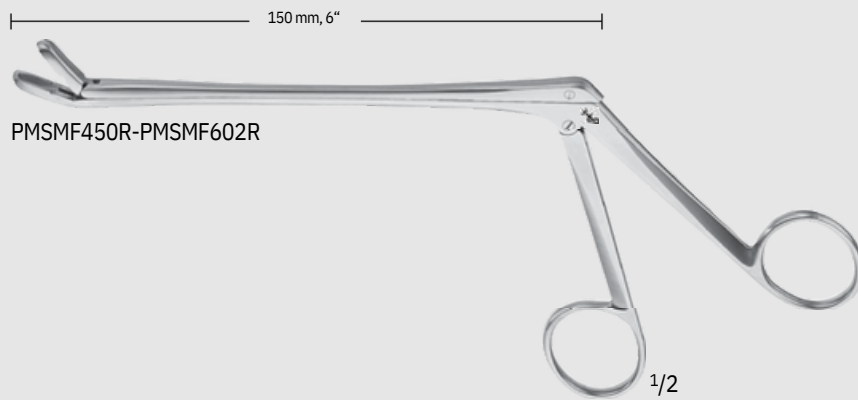

PMSMF450R-PMSMF602R

CLOWARD Style Rongeur

Catalog Number	Jaw Size (mm)	Jaw	Working Length (in.)
PMSMF450R	6 x 10	STR	5 1/4
PMSMF600R	6 x 10	STR	6
PMSMF451R	6 x 10	UP	5 1/4
PMSMF601R	6 x 10	UP	6
PMSMF452R	6 x 10	DOWN	5 1/4
PMSMF602R	6 x 10	DOWN	6



PMSMF450R-PMSMF602R



Orthopedics/Spine

Kerrison Bone Punches

SYPERT Kerrison Bone Punch

Catalog Number	Jaw Size (mm)	Tip	Working Length (in.)
PMSFG055R	5.5	40° UP	9 3/4



Three Primary Styles

- Non Detachable, silver
 - Detachable, silver
 - Detachable, ceramic NOIR coating
- For more information see our brochure DOC400.

Complete Size and Footplate Range

- Regular and thin footplates
- 7", 8", 9", 11" lengths
- 1-6 mm bite sizes
- 15 mm Laminectomy jaw length
- 40° and 90° up and down jaw positions



STANDARD

Working Length (in.)	Jaw Size (mm)	Footplate	Non Detachable, Silver	Ejector	Detachable, Silver	Ejector	Detachable, NOIR Coating	Ejector
7	1.0	STANDARD	PMSFF715R	-	PMSFK900R	-	PMSFK900B	-
7	1.5	STANDARD	PMSFF638R	-	PMSFK911R	-	PMSFK911B	-
7	2.0	STANDARD	PMSFF717R	-	PMSFK901R	-	PMSFK901B	-
7	2.5	STANDARD	PMSFF639R	-	PMSFK912R	-	PMSFK912B	-
7	3.0	STANDARD	PMSFF720R	-	PMSFK902R	-	PMSFK902B	-
7	4.0	STANDARD	PMSFF724R	-	PMSFK903R	-	PMSFK903B	-
7	5.0	STANDARD	PMSFF722R	-	PMSFK904R	-	PMSFK904B	-
7	6.0	STANDARD	PMSFF726R	-	PMSFK905R	-	PMSFK905B	-

7 7/8	1.0	STANDARD	PMSFF691R	-	PMSFK960R	-	PMSFK960B	-
7 7/8	1.5	STANDARD	PMSFF649R	-	PMSFK966R	-	PMSFK966B	-
7 7/8	2.0	STANDARD	PMSFF737R	-	PMSFK913R	-	PMSFK913B	-
7 7/8	2.5	STANDARD	PMSFF657R	-	PMSFK967R	-	PMSFK967B	-
7 7/8	3.0	STANDARD	PMSFF738R	-	PMSFK914R	-	PMSFK914B	-
7 7/8	4.0	STANDARD	PMSFF727R	-	PMSFK915R	-	PMSFK915B	-
7 7/8	5.0	STANDARD	PMSFF728R	-	PMSFK916R	-	PMSFK916B	-
7 7/8	6.0	STANDARD	PMSFF729R	-	PMSFK917R	-	PMSFK917B	-

9	1.0	STANDARD	PMSFF674R	-	PMSFK918R	-	PMSFK918B	-
9	2.0	STANDARD	PMSFF682R	-	PMSFK919R	-	PMSFK919B	-
9	3.0	STANDARD	PMSFF683R	-	PMSFK920R	-	PMSFK920B	-
9	4.0	STANDARD	PMSFF684R	-	PMSFK921R	-	PMSFK921B	-
9	5.0	STANDARD	PMSFF685R	-	PMSFK922R	-	PMSFK922B	-

11	1.0	STANDARD	PMSFF696R	-	PMSFK981R	-	PMSFK981B	-
11	2.0	STANDARD	PMSFF686R	-	PMSFK986R	-	PMSFK986B	-
11	3.0	STANDARD	PMSFF687R	-	PMSFK987R	-	PMSFK987B	-
11	4.0	STANDARD	PMSFF688R	-	PMSFK988R	-	PMSFK988B	-
11	5.0	STANDARD	PMSFF689R	-	PMSFK989R	-	PMSFK989B	-
11	6.0	STANDARD	PMSFF690R	-	-	-	-	-

Orthopedics/Spine

Kerrison Bone Punches

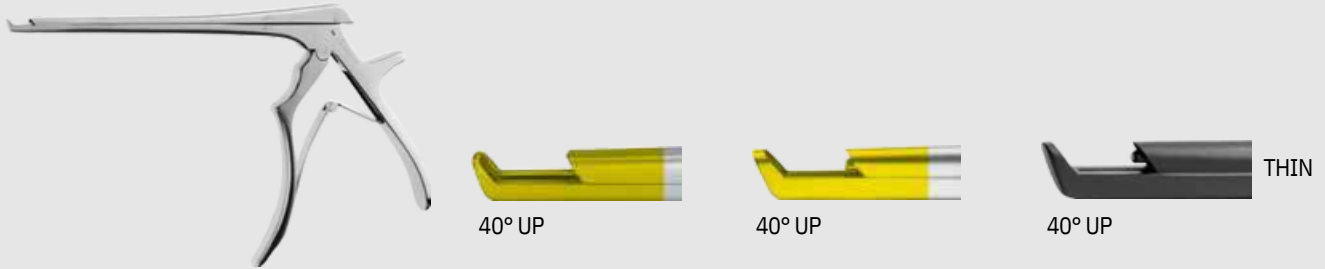

Working Length (in.)	Jaw Size (mm)	Footplate	Non Detachable, Silver	Ejector	Detachable, Silver	Ejector	Detachable, NOIR Coating	Ejector
7	1.0	THIN	PMSFF771R	-	PMSFK906R	-	PMSFK906B	-
7	1.5	THIN	PMSFF645R	-	PMSFK923R	-	PMSFK923B	-
7	2.0	THIN	PMSFF772R	-	PMSFK907R	-	PMSFK907B	-
7	2.5	THIN	PMSFF646R	-	PMSFK924R	-	PMSFK924B	-
7	3.0	THIN	PMSFF773R	-	PMSFK908R	-	PMSFK908B	-
7	4.0	THIN	PMSFF769R	-	PMSFK909R	-	PMSFK909B	-
7	5.0	THIN	PMSFF770R	-	PMSFK910R	-	PMSFK910B	-
7 7/8	1.0	THIN	PMSFF661R	-	PMSFK961R	-	PMSFK961B	-
7 7/8	1.5	THIN	PMSFF658R	-	PMSFK968R	-	PMSFK968B	-
7 7/8	2.0	THIN	PMSFF662R	-	PMSFK962R	-	PMSFK962B	-
7 7/8	2.5	THIN	PMSFF659R	-	PMSFK969R	-	PMSFK969B	-
7 7/8	3.0	THIN	PMSFF663R	-	PMSFK963R	-	PMSFK963B	-
7 7/8	4.0	THIN	PMSFF664R	-	PMSFK964R	-	PMSFK964B	-
7 7/8	5.0	THIN	PMSFF665R	-	PMSFK965R	-	PMSFK965B	-
9	1.0	THIN	PMSFF734R	-	PMSFK929R	-	PMSFK929B	-
9	2.0	THIN	PMSFF746R	-	PMSFK925R	-	PMSFK925B	-
9	3.0	THIN	PMSFF747R	-	PMSFK926R	-	PMSFK926B	-
9	4.0	THIN	PMSFF748R	-	PMSFK927R	-	PMSFK927B	-
9	5.0	THIN	PMSFF749R	-	PMSFK928R	-	PMSFK928B	-
11	1.0	THIN	PMSFF673R	-	PMSFK980R	-	PMSFK980B	-
11	2.0	THIN	PMSFF666R	-	PMSFK976R	-	PMSFK976B	-
11	3.0	THIN	PMSFF667R	-	PMSFK977R	-	PMSFK977B	-
11	4.0	THIN	PMSFF668R	-	PMSFK978R	-	PMSFK978B	-
11	5.0	THIN	PMSFF669R	-	PMSFK979R	-	PMSFK979B	-

ORTHO
SPINE

MILLIMETERS



STANDARD

Working Length (in.)	Jaw Size (mm)	Jaw Opening (mm)	Footplate	Non Detachable, Silver	Ejector	Detachable, Silver	Ejector	Detachable, NOIR Coating	Ejector
7	2.0	15	STANDARD	PMSFF677R	-	PMSFK971R		PMSFK971B	
7	3.0	15	STANDARD	PMSFF678R	-	PMSFK972R		PMSFK972B	
7	4.0	15	STANDARD	PMSFF679R	-	PMSFK973R		PMSFK973B	
7	5.0	15	STANDARD	PMSFF680R	-	PMSFK974R		PMSFK974B	
7	6.0	15	STANDARD	-	-	PMSFK975R		PMSFK975B	

7 7/8	2.0	15	STANDARD	PMSFF660R	-	PMSFK970R		PMSFK970B	
7 7/8	3.0	15	STANDARD	PMSFF739R	-	PMSFK982R		PMSFK982B	
7 7/8	4.0	15	STANDARD	PMSFF745R	-	PMSFK983R		PMSFK983B	
7 7/8	5.0	15	STANDARD	PMSFF751R	-	PMSFK984R		PMSFK984B	
7 7/8	6.0	15	STANDARD	PMSFF753R	-	PMSFK985R		PMSFK985B	



STANDARD

90° UP

Working Length (in.)	Jaw Size (mm)	Jaw Opening (mm)	Non Detachable, Silver	Ejector
7	3	15	PMSFF136R	-
7	4	15	PMSFF137R	-
7	5	15	PMSFF138R	-

8	3	15	PMSFF086R	-
8	4	15	PMSFF087R	-
8	5	15	PMSFF088R	-

Orthopedics/Spine

Kerrison Bone Punches

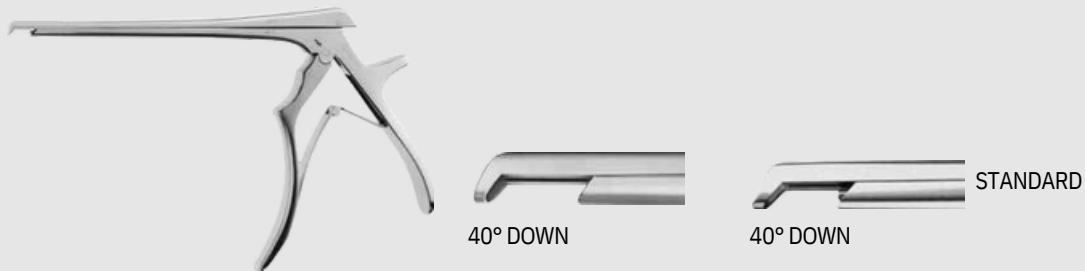

Working Length (in.)	Jaw Size (mm)	Footplate	Non Detachable, Silver	Ejector	Detachable, Silver	Ejector
7	1.0	STANDARD	PMSFF711R	-	PMSFK930R	-
7	2.0	STANDARD	PMSFF712R	-	PMSFK931R	
7	3.0	STANDARD	PMSFF713R	-	PMSFK932R	
7	4.0	STANDARD	PMSFF714R	-	PMSFK933R	
7	5.0	STANDARD	PMSFF725R	-	PMSFK934R	

9	2.0	STANDARD	PMSFF692R	-	PMSFK943R	
9	3.0	STANDARD	PMSFF693R	-	PMSFK944R	
9	4.0	STANDARD	PMSFF694R	-	PMSFK945R	
9	5.0	STANDARD	PMSFF695R	-	PMSFK946R	



Working Length (in.)	Jaw Size (mm)	Footplate	Non Detachable, Silver	Ejector	Detachable, Silver	Ejector
7	1.0	THIN	PMSFF781R	-	PMSFK936R	-
7	2.0	THIN	PMSFF782R	-	PMSFK937R	
7	3.0	THIN	PMSFF783R	-	PMSFK938R	
7	4.0	THIN	PMSFF784R	-	PMSFK939R	
7	5.0	THIN	PMSFF785R	-	PMSFK940R	

ORTHO
SPINE

MILLIMETERS



Working Length (in.)	Jaw Size (mm)	Footplate	Non Detachable, Silver	Ejector	Detachable, Silver	Ejector	Detachable NOIR Coating	Ejector
7	1.0	STANDARD	PMSFF716R	-	PMSFK948R	-	PMSFK948B	-
7	2.0	STANDARD	PMSFF718R	-	PMSFK949R	-	PMSFK949B	
7	3.0	STANDARD	PMSFF750R	-	PMSFK950R		PMSFK950B	
7	4.0	STANDARD	PMSFF752R	-	PMSFK951R		PMSFK951B	
7	5.0	STANDARD	PMSFF754R	-	PMSFK952R		PMSFK952B	
7	6.0	STANDARD	PMSFF755R	-	PMSFK953R		PMSFK953B	

8	1.0	STANDARD	PMSFF025R	-
8	2.0	STANDARD	PMSFF026R	-
8	3.0	STANDARD	PMSFF027R	-
8	4.0	STANDARD	PMSFF028R	-
8	5.0	STANDARD	PMSFF029R	-



Working Length (in.)	Jaw Size (mm)	Footplate	Non Detachable, Silver	Ejector
7	1	THIN	PMSFF115R	-
7	2	THIN	PMSFF116R	-
7	3	THIN	PMSFF117R	-
7	4	THIN	PMSFF118R	-
7	5	THIN	PMSFF119R	-

8	2	THIN	PMSFF077R	-
8	3	THIN	PMSFF078R	-
8	4	THIN	PMSFF079R	-
8	5	THIN	PMSFF080R	-



Orthopedics/Spine

Kerrison Bone Punches

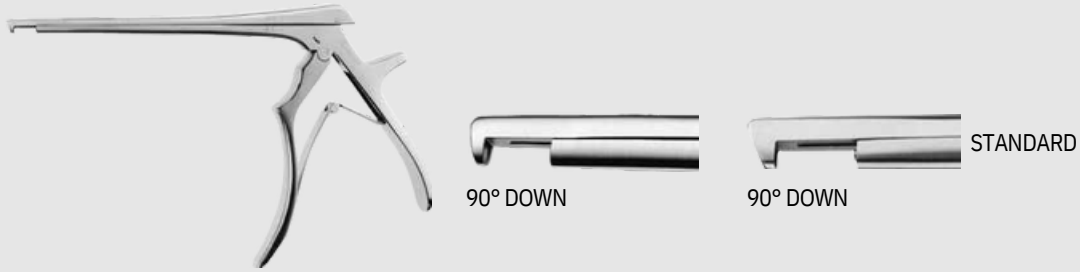

Working Length (in.)	Jaw Size (mm)	Footplate	Non Detachable, Silver	Ejector	Detachable, Silver	Ejector
7	1.0	STANDARD	PMSFF741R	-	PMSFK954R	-
7	2.0	STANDARD	PMSFF719R	-	PMSFK955R	-
7	3.0	STANDARD	PMSFF721R	-	PMSFK956R	-
7	4.0	STANDARD	PMSFF742R	-	PMSFK957R	-
7	5.0	STANDARD	PMSFF723R	-	PMSFK958R	-
7	6.0	STANDARD	PMSFF743R	-		

8	2	STANDARD	PMSFF828R	-
8	3	STANDARD	PMSFF829R	-
8	4	STANDARD	PMSFF830R	-
8	5	STANDARD	PMSFF831R	-
8	6	STANDARD	PMSFF841R	-



Working Length (in.)	Jaw Size (mm)	Footplate	Non Detachable, Silver	Ejector
7	1.0	THIN	PMSMF136R	-
7	2.0	THIN	PMSFF816R	-
7	3.0	THIN	PMSFF817R	-
7	4.0	THIN	PMSFF819R	-
7	5.0	THIN	PMSFF821R	-

8	1.0	THIN	PMSFF809R	-
8	2.0	THIN	PMSFF812R	-
8	3.0	THIN	PMSFF813R	-
8	5.0	THIN	PMSFF815R	-

ORTHO SPINE

MILLIMETERS

Foraminotomy Kerrison

- Non Detachable design
- Upward curve allows for easier bone removal, providing improved access to the underside of the foramen

KERRISON Foraminotomy Bone Punch

Catalog Number	Jaw Size (mm)	Jaw Opening (mm)	Working Length (in.)
PMSFF466R	2.0	10	7 7/8
PMSFF467R	3.0	10	7 7/8
PMSFF468R	4.0	10	7 7/8
PMSFF469R	5.0	10	7 7/8

PMSFF466R-PMSFF469R

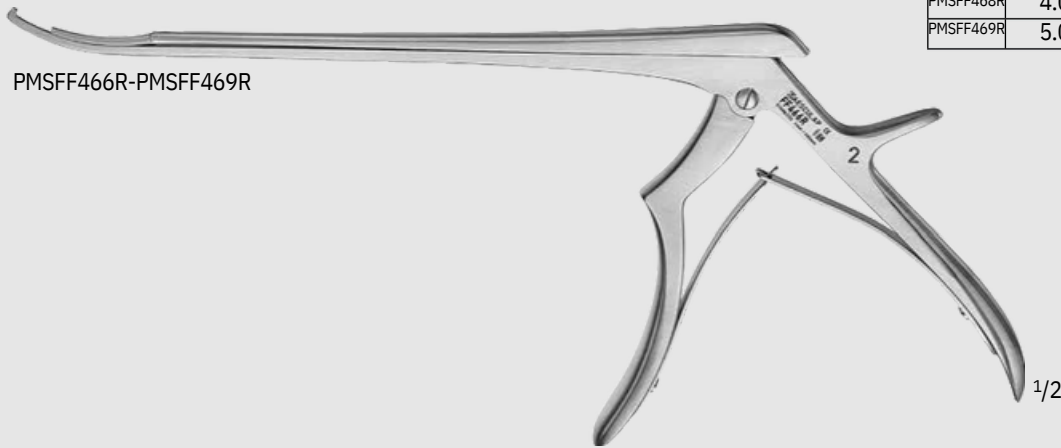

Bayonet-Shaped Kerrison bone punch

- Non Detachable design
- Bayonet shape allows better view over the KERRISON and increased visibility of surgical site
- Easily used through a retractor tube for MIS procedures

KERRISON Bayonet-Shaped Bone Punch, 40° upbiting

Catalog Number	Jaw Size (mm)	Jaw Opening (mm)	Working Length (in.)
PMSFF496R	2.0	10	9 1/2
PMSFF497R	3.0	10	9 1/2
PMSFF498R	4.0	10	9 1/2
PMSFF499R	5.0	10	9 1/2

PMSFF496R-PMSFF499R



Orthopedics/Spine

KAIRison® Pneumatic Bone Punch

KAIRison Pneumatic Bone Punch ■ Easy handling ■ Reduces physical effort required ■ Relieves strain on hands and joints ■ Less risk of reduced motor skills through fatigue ■ Innovative safety mechanism ■ Short learning curve ■ Excellent balance ■ Suitable for right- or left-handed use ■ Reliable; does not jam ■ Ergonomic design For more information see our brochure PMSDOC763.

KAIRison Pneumatic Bone Punch

Catalog Number	Jaw Size (mm)	Jaw Opening (mm)	Footplate	Ejector	Total Length (in.)
PMSFK882R	2.0	12	STANDARD		9 1/4
PMSFK883R	3.0	12	STANDARD		9 1/4
PMSFK884R	4.0	12	STANDARD		9 1/4
PMSFK885R	5.0	12	STANDARD		9 1/4
PMSFK886R	6.0	12	STANDARD		9 1/4
PMSFK892R	2.0	12	STANDARD		11 1/4
PMSFK893R	3.0	12	STANDARD		11 1/4
PMSFK894R	4.0	12	STANDARD		11 1/4
PMSFK895R	5.0	12	STANDARD		11 1/4
PMSFK896R	6.0	12	STANDARD		11 1/4

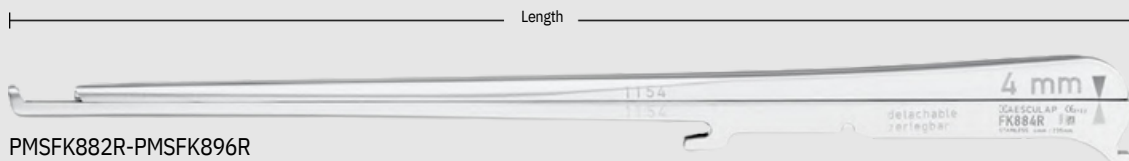

PMSFK882R-PMSFK896R

Width (mm) 2.0 3.0 4.0 5.0 6.0

KAIRison Pneumatic Punch Handle

PMSFK899R



Catalog Number
PMSFK899R

Punch Bracket For Pressure Reducer



Pressure Reducer

PMSFK898R-PMSFK898214

KAIRison Pressure Reducer

Catalog Number	Description
PMSFK898R	PRESSURE REDUCER
PMSFK887R	BRACKET FOR PRESSURE REDUCER
PMSFK898215	RUBBER CAP, SMALL
PMSFK898214	RUBBER CAP, LARGE

ORTHO
SPINE



PMSFK888SU

Disposable Tubes for KAIRison Pneumatic Punch

Catalog Number	Packaging
PMSFK888SU	PAK = Package of 10

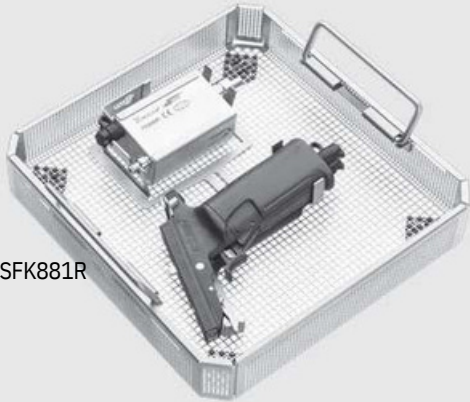

PMSFK881R

Storage Rack for KAIRison Handle and Pressure Reducer

Catalog Number
PMSFK881R

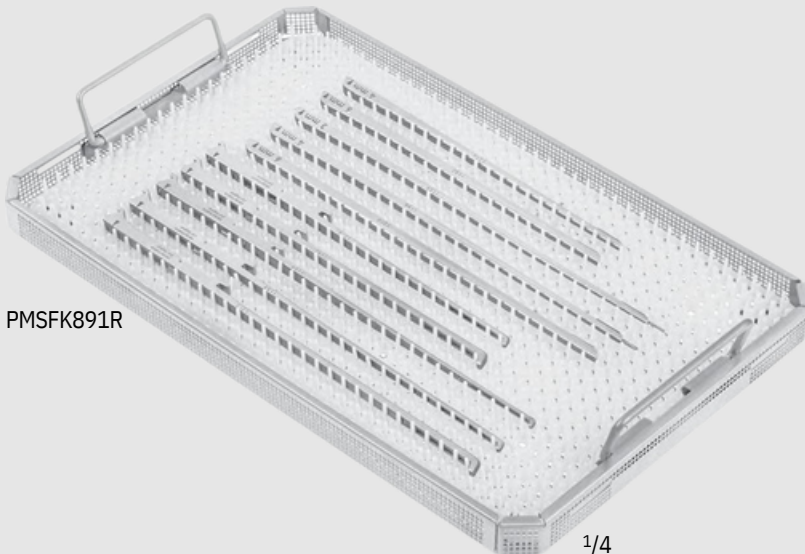

PMSFK891R

1/4

Storage Rack for KAIRison Shafts

Catalog Number
PMSFK891R



PMSG468R

Pneumatic Hose with Aesculap-Schrader Connection

Catalog Number	Length (m)
PMSG468R	5



Orthopedics/Spine

Bone Cutters

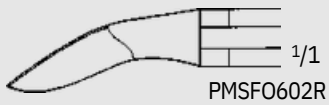
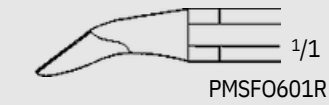
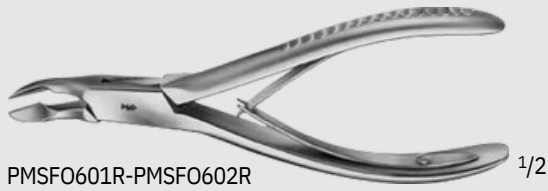

Bone Cutting Forceps

Catalog Number	Jaw	Length (in.)
PMSFO601R	UP	5 1/8
PMSFO602R	UP	6 3/4

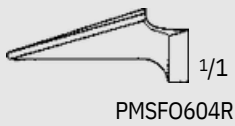

STAMM Bone Cutting Forceps

Catalog Number	Length (in.)
PMSFO604R	6

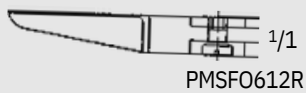

Bone Cutting Forceps, Double Action

Catalog Number	Jaw	Length (in.)
PMSFO612R	STR	6 3/4

ORTHO
SPINE

MILLIMETERS

LISTON Bone Cutting Forceps

Catalog Number	Jaw	Length (in.)
PMSFO620R	STR, Single Action	5 1/2
PMSFO622R	STR, Single Action	6 3/4
PMSFO624R	STR, Single Action	7 7/8
PMSFO626R	STR, Single Action	8 3/4
PMSFO632R	ANG, Single Action	6 3/4
PMSFO634R	ANG, Single Action	7 7/8
PMSFO636R	ANG, Single Action	8 3/4
PMSFO645R	CVD, Double Action	9 1/2
PMSFO646R	STR, Double Action	11
PMSFO647R	CVD, Double Action	11



PMSFO620R-PMSFO636R

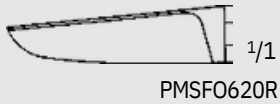

PMSFO620R

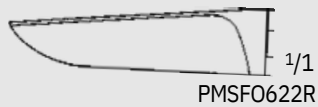

PMSFO622R



PMSFO624R

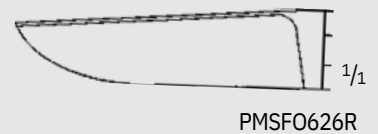

PMSFO626R

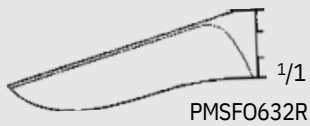

PMSFO632R

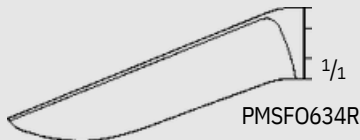

PMSFO634R



PMSFO636R

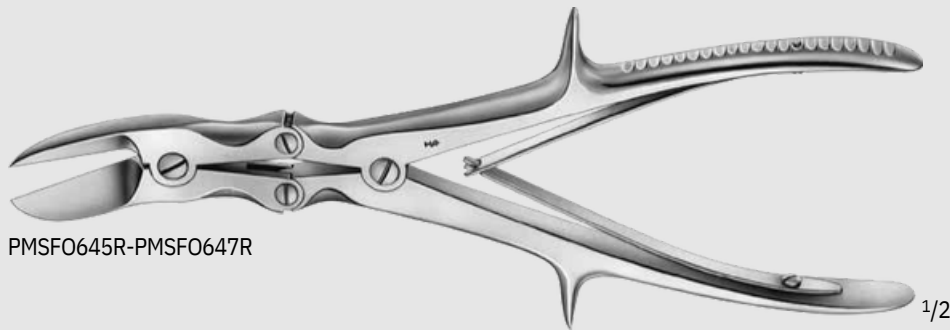

PMSFO645R-PMSFO647R

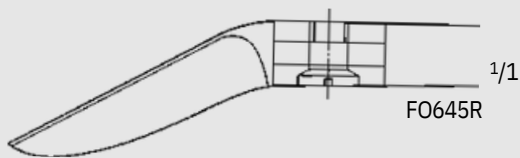

FO645R

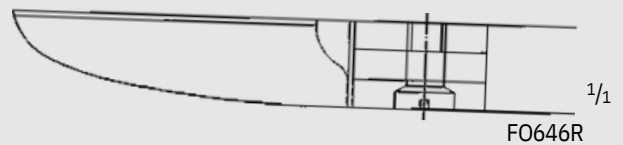

FO646R

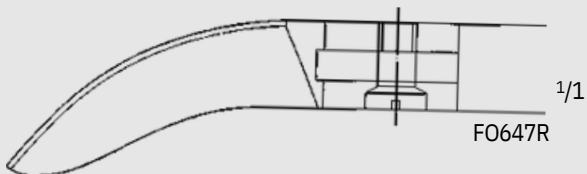

FO647R



INCHES

Orthopedics/Spine

Bone Cutters



PMSFO610R-PMSFO611R

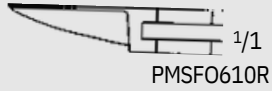

PMSFO610R

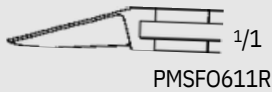

PMSFO611R

BOEHLER Bone Cutting Forceps, Double Action

Catalog Number	Jaw	Length (in.)
PMSFO610R	STR	5 3/4
PMSFO611R	ANG	5 3/4



PMSFO614R

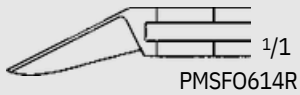

PMSFO614R

MCINDOE Bone Cutting Forceps, Double Action

Catalog Number	Jaw	Length (in.)
PMSFO614R	ANG	6 7/8



PMSFO640R-PMSFO641R

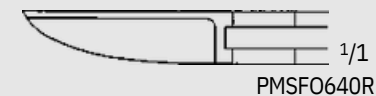

PMSFO640R



PMSFO641R

RUSKIN-LISTON Bone Cutting Forceps, Double Action

Catalog Number	Jaw	Length (in.)
PMSFO640R	STR	7 1/2
PMSFO641R	ANG	7 1/2

ORTHO
SPINE

MILLIMETERS



PMSFO648R

1/3

LISTON-STILLE Bone Cutting Forceps, 90° Angle

Catalog Number	Length (in.)
PMSFO648R	10 1/2

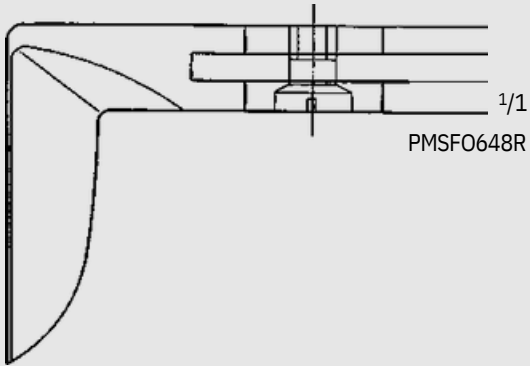

1/1

PMSFO648R



PMSFO649R

1/3

LISTON-KEY-HORSLEY Bone Cutting Forceps, Angled

Catalog Number	Length (in.)
PMSFO649R	10

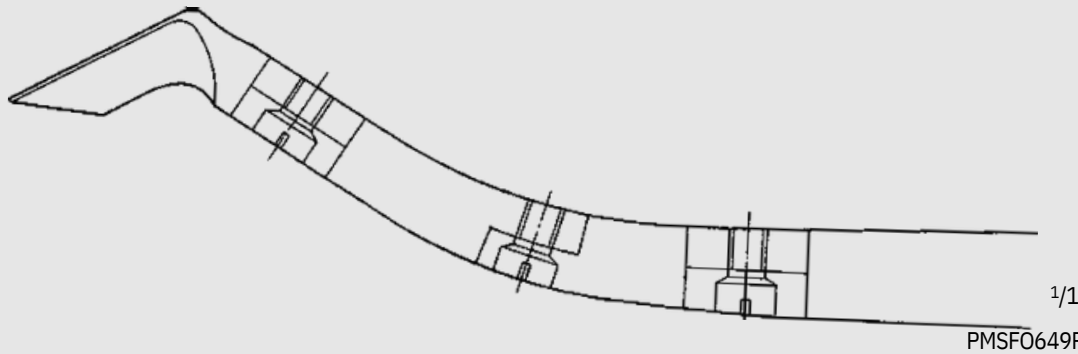

1/1

PMSFO649R



PMSOK378R

1/2

KAZANJIAN Bone Cutting Forceps, Straight

Catalog Number	Length (in.)
PMSOK378R	7 1/4

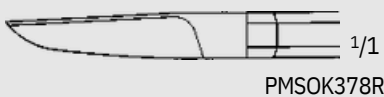

1/1

PMSOK378R



Orthopedics/Spine

Rulers, Calipers and Gauges



PMSAA847R

Caliper for Inner Diameter and Outer Diameter

Catalog Number	Measuring Range	Length (in.)
PMSAA847R	UP TO 100MM	5 1/8
PMSAA846R	UP TO 150MM	9



PMSAA846R

TESSIER Type Caliper

Catalog Number	Length (in.)
PMSMA004R	10 1/4

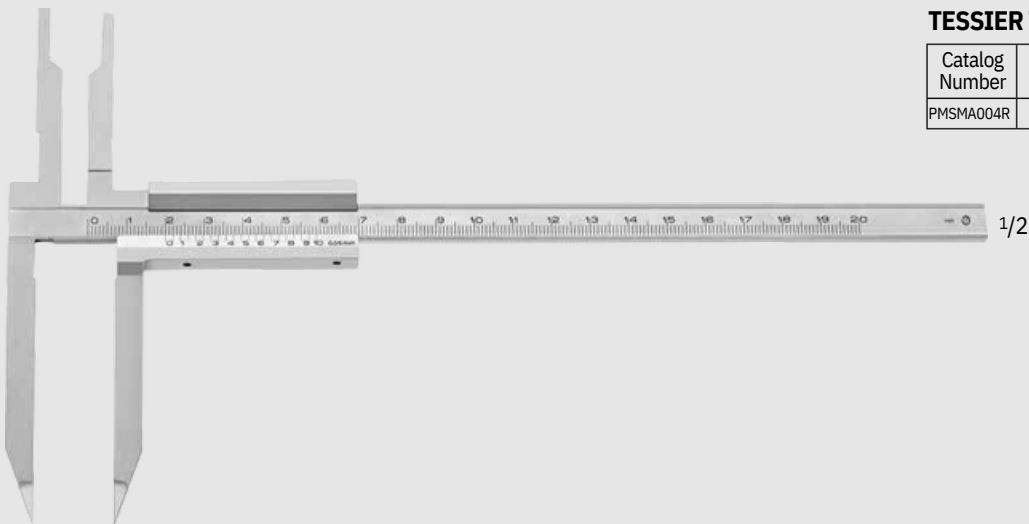

PMSMA004R

CASPAR Neuro Caliper F/ Bone Graft

Catalog Number	Length (in.)
PMSAA845R	8 7/8

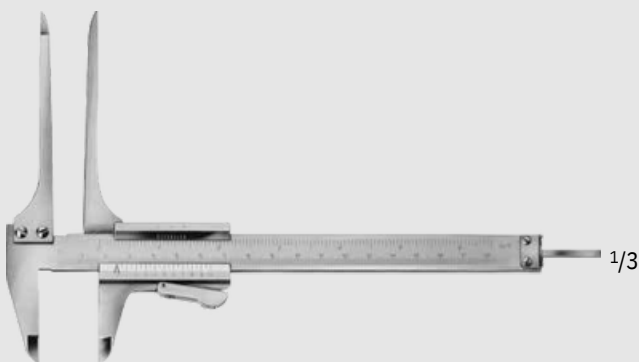

PMSAA845R



Orthopedics/Spine

Rulers, Calipers and Gauges

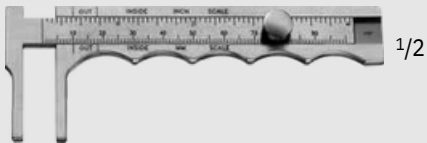

PMSMB983R

TOWNLEY Femur Caliper

Catalog Number	Length (in.)
PMSMB983R	4

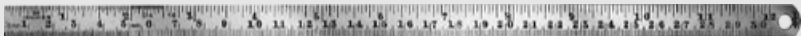

PMSAA804R-PMSAA806R

Steel Ruler, Graduated In Millimeters and Inches

Catalog Number	Length (in.)
PMSAA804R	6
PMSAA805R	11 3/4
PMSAA806R	19 3/4



PMSMD531R

CLOWARD Style Depth Gauges

Catalog Number	Size	Length (in.)
PMSMD531R	LARGE	8

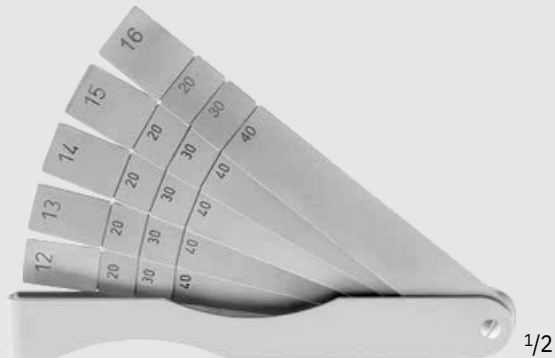

PMSMD534R

CLOWARD Spanner Gauges

Catalog Number	Length (in.)
PMSMD534R	5





PARKER MEDICAL SUPPLIES

CONTACT US



+1 (832) 343-3140



info@parkermedicalsupplies.com



www.parkermedicalsupplies.com

VISIT US:

2800 Post Oak Blvd, Ste 5600, Houston TX 77056, United States